



CAGE Code 81205

737-100 through 737-500 Airplane Characteristics for Airport Planning

DOCUMENT NUMBER:

D6-58325-6

REVISION:

Rev D

REVISION DATE:

March 2023

CONTENT OWNER:

Boeing Commercial Airplanes

All revisions to this document must be approved by the content owner before release.

Not Subject to US Export Administration Regulations (EAR), (15 C.F.R. Parts 730-774) or US International Traffic in Arms Regulations (ITAR), (22 C.F.R. Parts 120-130).



Revision Record

Revision Letter	D
Revision Date	March 2023
Changes in This Revision	Separating the 737 Airplane Characteristics for Airport Planning Manual (D6-58325-6) for 737 Classic and Next Generation Airplanes. This document now gives Airplane Characteristics for Airport Planning information for 737-100/ -200/ -300/ -400/ -500 model airplanes only.

Revision Letter	C
Revision Date	October 2021
Changes in This Revision	Section 2.0 Incorporation of 737-800BCF Airplane Description

Revision Letter	B
Revision Date	September 2021
Changes in This Revision	Section 6.0 Jet Engine Exhaust Velocity Contours, Inlet Hazard Areas

Revision Letter	A
Revision Date	September 2020
Changes in This Revision	New document format All Models: ICAO Aerodrome Reference Code Section 3.0 Airplane Performance

Table of Contents

1.0	SCOPE AND INTRODUCTION	1-1
1.1	SCOPE	1-1
1.2	INTRODUCTION	1-2
1.3	A BRIEF DESCRIPTION OF THE 737 FAMILY OF AIRPLANES.....	1-3
2.0	AIRPLANE DESCRIPTION.....	2-1
2.1	GENERAL CHARACTERISTICS	2-1
2.1.1	General Characteristics: Model 737-100	2-2
2.1.2	General Characteristics: Model 737-200	2-3
2.1.3	General Characteristics: Model 737-200	2-4
2.1.4	General Characteristics: Model 737-200, Convertible and Executive Airplanes	2-5
2.1.5	General Characteristics: Model Advanced 737-200C, -200QC.....	2-6
2.1.6	General Characteristics: Model 737-300	2-7
2.1.7	General Characteristics: Model 737-400	2-8
2.1.8	General Characteristics: Model 737-500	2-9
2.2	GENERAL DIMENSIONS	2-10
2.2.1	General Dimensions: Model 737-100	2-10
2.2.2	General Dimensions: Model 737-200	2-11
2.2.3	General Dimensions: Model 737-300	2-12
2.2.4	General Dimensions: Model 737-300W	2-13
2.2.5	General Dimensions: Model 737-400	2-14
2.2.6	General Dimensions: Model 737-500	2-15
2.3	GROUND CLEARANCES	2-16
2.3.1	Ground Clearances: Model 737-100, -200, -200C.....	2-16
2.3.2	Ground Clearances: Model 737-300, -400, -500	2-17
2.4	INTERIOR ARRANGEMENTS.....	2-18
2.4.1	Interior Arrangements: Model 737-100	2-18
2.4.2	Interior Arrangements: Model 737-200	2-19
2.4.3	Interior Arrangements: Model 737-200, Mixed Class	2-20
2.4.4	Interior Arrangements: Model 737-200 Executive Interior Class.....	2-21
2.4.5	Interior Arrangements: Model 737-200 Passenger/Cargo Configuration	2-22
2.4.6	Interior Arrangements: Model 737-200C, All Cargo Configuration	2-23
2.4.7	Interior Arrangements: Model 737-300	2-24
2.4.8	Interior Arrangements: Model 737-400	2-25
2.4.9	Interior Arrangements: Model 737-500	2-26
2.5	CABIN CROSS SECTIONS	2-27

2.5.1	Cabin Cross-Sections: Model 737-100, Six-Abreast Seating With Hatrack-Type Stowage System	2-27
2.5.2	Cabin Cross-Sections: Model 737-200, Four-Abreast Seating With “Wide-Body Look” Interior	2-28
2.5.3	Cabin Cross-Sections: Model 737-200, Five-Abreast Seating With Carry All Compartments	2-29
2.5.4	Cabin Cross-Sections: Model 737-200ADV, -300, -400, -500, Four-Abreast Seating	2-30
2.5.5	Cabin Cross-Sections: Model 737-200ADV, -300, -400, -500, Six-Abreast Seating.....	2-31
2.6	LOWER CARGO COMPARTMENTS	2-32
2.6.1	Lower Cargo Compartments: Model 737-100, -200, -300, -400, -500, Dimensions.....	2-32
2.6.2	Lower Cargo Compartments: Model 737-100, -200, Capacities	2-33
2.6.3	Lower Cargo Compartments: Model 737-300, -400, -500, Capacities	2-34
2.7	DOOR CLEARANCES.....	2-35
2.7.1	Door Clearances: Model 737, All Models, Forward Main Entry Door No. 1	2-35
2.7.2	Door Clearances: Model 737, All Models, Optional Forward Airstairs, Main Entry Door No 1.....	2-36
2.7.3	Door Clearances: Models 737-100, -200, -300, -400, -500, Locations of Sensors and Probes – Forward of Main Entry Door No 1	2-37
2.7.4	Door Clearances: Model 737, All Models, Forward Service Door.....	2-38
2.7.5	Door Clearances: Model 737, All Models, Aft Entry Door and Aft Service Door.....	2-39
2.7.6	Door Clearances: Model 737-100, -200, Aft Entry Door With Optional Airstair.....	2-40
2.7.7	Door Clearances: Model 737, All Models, Lower Deck Cargo Compartments	2-41
2.7.8	Door Clearances: Model 737-200C, Main Deck Cargo Door.....	2-42
3.0	AIRPLANE PERFORMANCE	3-1
3.1	GENERAL INFORMATION.....	3-1
3.2	PAYLOAD/RANGE FOR LONG RANGE CRUISE	3-2
3.2.1	Payload/Range for Long Range Cruise: Model 737-100 (JT8D-7 Engines).....	3-2
3.2.2	Payload/Range for Long Range Cruise: Model 737-200 (JT8D-9/9A Engines).....	3-3
3.2.3	Payload/Range for Long Range Cruise: Model 737-200 (JT8D-15/15A Engines).....	3-4
3.2.4	Payload/Range for Long Range Cruise: Model 737-200ADV (JT8D-17/17A Engines).....	3-5

3.2.5	Payload/Range for Long Range Cruise: Model 737-200ADV (JT8D-17R/17AR Engines).....	3-6
3.2.6	Payload/Range for Long Range Cruise: Model 737-300.....	3-7
3.2.7	Payload/Range for Long Range Cruise: Model 737-400.....	3-8
3.2.8	Payload/Range for Long Range Cruise: Model 737-500.....	3-9
3.3	F.A.R. AND J.A.R. TAKEOFF RUNWAY LENGTH REQUIREMENTS	3-10
3.3.1	F.A.R. Takeoff Runway Length Requirements - Standard Day: Model 737-100 (JT8D-7 Engines).....	3-10
3.3.2	F.A.R. Takeoff Runway Length Requirements - Standard Day + 27°F (STD + 15°C): Model 737-100 (JT8D-7 Engines).....	3-11
3.3.3	F.A.R. Takeoff Runway Length Requirements – Standard Day: Model 737-200 (JT8D-9/9A Engines).....	3-12
3.3.4	F.A.R. Takeoff Runway Length Requirements - Standard Day + 27°F (STD + 15°C): Model 737-200 (JT8D-9/9A Engines).....	3-13
3.3.5	F.A.R. Takeoff Runway Length Requirements - Standard Day: Model 737-200ADV (JT8D-15/15A Engines).....	3-14
3.3.6	F.A.R. Takeoff Runway Length Requirements - Standard Day + 27°F (STD + 15°C): Model 737-200ADV (JT8D-15/15A Engines).....	3-15
3.3.7	F.A.R. Takeoff Runway Length Requirements - Standard Day: Model 737-200ADV (JT8D-17/17A Engines).....	3-16
3.3.8	F.A.R. Takeoff Runway Length Requirements - Standard Day + 27°F (STD + 15°C): Model 737-200ADV (JT8D-17/17A Engines).....	3-17
3.3.9	F.A.R. Takeoff Runway Length Requirements - Standard Day: Model 737-200ADV (JT8D-17R/17AR Engines).....	3-18
3.3.10	F.A.R. Takeoff Runway Length Requirements - Standard Day + 27°F (STD + 15°C): Model 737-200ADV (JT8D-17R/17AR Engines).....	3-19
3.3.11	F.A.R. Takeoff Runway Length Requirements - Standard Day: Model 737-300 (CFM56-3B1 Engines at 20,000 LB SLST).....	3-20
3.3.12	F.A.R. Takeoff Runway Length Requirements - Standard Day + 27°F (STD + 15°C): Model 737-300 (CFM56-3B1 Engines at 20,000 LB SLST).....	3-21
3.3.13	F.A.R. Takeoff Runway Length Requirements - Standard Day: Model 737-300 (CFM56-3B-2 Engines at 22,000 LB SLST).....	3-22
3.3.14	F.A.R. Takeoff Runway Length Requirements - Standard Day + 27°F (STD + 15°C): Model 737-300 (CFM56-3B-2 Engines at 22,000 LB SLST).....	3-23
3.3.15	F.A.R. Takeoff Runway Length Requirements - Standard Day: Model 737-400 (CFM56-3B-2 Engines at 22,000 LB SLST).....	3-24

3.3.16	F.A.R. Takeoff Runway Length Requirements - Standard Day + 27°F (STD + 15°C): Model 737-400 (CFM56-3B-2 Engines at 22,000 LB SLST)	3-25
3.3.17	F.A.R. Takeoff Runway Length Requirements - Standard Day: Model 737-400 (CFM56-3C1 Engines at 23,500 LB SLST).....	3-26
3.3.18	F.A.R. Takeoff Runway Length Requirements - Standard Day + 27°F (STD + 15°C): Model 737-400 (CFM56-3C1 Engines at 23,500 LB SLST)	3-27
3.3.19	F.A.R. Takeoff Runway Length Requirements - Standard Day: Model 737-500 (CFM56-3B-1 Engines at 20,000 LB SLST)	3-28
3.3.20	F.A.R. Takeoff Runway Length Requirements - Standard Day + 27°F (STD + 15°C): Model 737-500 (CFM56-3B-1 Engines at 20,000 LB SLST)	3-29
3.3.21	F.A.R. Takeoff Runway Length Requirements - Standard Day: Model 737-500 (CFM56-3B-1 Engines at 18,500 LB SLST)	3-30
3.3.22	F.A.R. Takeoff Runway Length Requirements - Standard Day + 27°F (STD + 15°C): Model 737-500 (CFM56-3B-1 Engines at 18,500 LB SLST)	3-31
3.4	F.A.R. AND J.A.R. LANDING RUNWAY LENGTH REQUIREMENTS	3-32
3.4.1	F.A.R. Landing Runway Length Requirements - Flaps 40: Model 737-100	3-32
3.4.2	F.A.R. Landing Runway Length Requirements - Flaps 30: Model 737-100	3-33
3.4.3	F.A.R. Landing Runway Length Requirements - Flaps 25: Model 737-100	3-34
3.4.4	F.A.R. Landing Runway Length Requirements - Flaps 40: Model 737-200, -200C	3-35
3.4.5	F.A.R. Landing Runway Length Requirements - Flaps 30: Model 737-200, -200C	3-36
3.4.6	F.A.R. Landing Runway Length Requirements - Flaps 25: Model 737-200, -200C	3-37
3.4.7	F.A.R. Landing Runway Length Requirements - Flaps 40: Model 737-200ADV, -200C	3-38
3.4.8	F.A.R. Landing Runway Length Requirements - Flaps 30: Model 737-200ADV, -200C	3-39
3.4.9	F.A.R. Landing Runway Length Requirements - Flaps 15: Model 737-200ADV, -200C	3-40
3.4.10	F.A.R. Landing Runway Length Requirements - Flaps 40: Model 737-300	3-41
3.4.11	F.A.R. Landing Runway Length Requirements - Flaps 30: Model 737-300	3-42
3.4.12	F.A.R. Landing Runway Length Requirements - Flaps 15: Model 737-300	3-43

3.4.13	F.A.R. Landing Runway Length Requirements - Flaps 40: Model 737-400	3-44
3.4.14	F.A.R. Landing Runway Length Requirements - Flaps 30: Model 737-400	3-45
3.4.15	F.A.R. Landing Runway Length Requirements - Flaps 15: Model 737-400	3-46
3.4.16	F.A.R. Landing Runway Length Requirements - Flaps 40: Model 737-500	3-47
3.4.17	F.A.R. Landing Runway Length Requirements - Flaps 30: Model 737-500	3-48
3.4.18	F.A.R. Landing Runway Length Requirements - Flaps 15: Model 737-500	3-49
4.0	AIRPLANE PERFORMANCE	4-1
4.1	GENERAL INFORMATION.....	4-1
4.2	TURNING RADII	4-2
4.2.1	Turning Radii – No Slip Angle: Model 737-100	4-2
4.2.2	Turning Radii – No Slip Angle: Model 737-200	4-3
4.2.3	Turning Radii – No Slip Angle: Model 737-300	4-4
4.2.4	Turning Radii – No Slip Angle: Model 737-300W	4-5
4.2.5	Turning Radii – No Slip Angle: Model 737-400	4-6
4.2.6	Turning Radii – No Slip Angle: Model 737-500	4-7
4.3	CLEARANCE RADII	4-8
4.3.1	Minimum Turning Radii – 3” Slip Angle: Model 737-100, -200	4-8
4.3.2	Minimum Turning Radii – 3” Slip Angle: Model 737-300, - 300W, -400, -500	4-9
4.4	VISIBILITY FROM COCKPIT IN STATIC POSITION: MODEL 737, ALL MODELS	4-10
4.5	RUNWAY AND TAXIWAY TURN PATHS	4-11
4.5.1	Runway and Taxiway Turn Paths - Runway-to-Taxiway, More Than 90 Degrees, Nose Gear Tracks Centerline: Model 737, All Models.....	4-11
4.5.2	Runway and Taxiway Turn Paths - Runway-to-Taxiway, 90 Degrees, Nose Gear Tracks Centerline: Model 737, All Models.....	4-12
4.5.3	Runway and Taxiway Turn Paths - Taxiway-to-Taxiway, 90 Degrees, Nose Gear Tracks Centerline: Model 737, All Models.....	4-13
4.5.4	Runway and Taxiway Turn Paths - Taxiway-to-Taxiway, 90 Degrees, Cockpit Tracks Centerline: Model 737, All Models.....	4-14
4.6	RUNWAY HOLDING BAY: MODEL 737, ALL MODELS	4-15
5.0	TERMINAL SERVICING	5-1
5.1	AIRPLANE SERVICING ARRANGEMENT - TYPICAL TURNAROUND	5-2

5.1.1	Airplane Servicing Arrangement - Typical Turnaround: Model 737-100	5-2
5.1.2	Airplane Servicing Arrangement - Typical Turnaround: Model 737-200	5-3
5.1.3	Airplane Servicing Arrangement - Typical Turnaround: Model 737-300	5-4
5.1.4	Airplane Servicing Arrangement - Typical Turnaround: Model 737-400	5-5
5.1.5	Airplane Servicing Arrangement - Typical Turnaround: Model 737-500	5-6
5.2	TERMINAL OPERATIONS - TURNAROUND STATION	5-7
5.2.1	Terminal Operations - Turnaround Station: Model 737-100, -200	5-7
5.2.2	Terminal Operations - Turnaround Station – Passenger/Cargo: Model 737-200C	5-8
5.2.3	Terminal Operations - Turnaround Station – All Cargo: Model 737-200C	5-9
5.2.4	Terminal Operations – Turnaround Station: Model 737-300, -400, -500	5-10
5.3	TERMINAL OPERATIONS - EN ROUTE STATION	5-11
5.3.1	Terminal Operations - En Route Station: Model 737-100, -200, -300, -400, -500	5-11
5.4	GROUND SERVICING CONNECTIONS	5-12
5.4.1	Ground Service Connections: Model 737-100	5-12
5.4.2	Ground Service Connections: Model 737-200	5-13
5.4.3	Ground Service Connections: Model 737-300	5-14
5.4.4	Ground Service Connections: Model 737-400	5-15
5.4.5	Ground Service Connections: Model 737-500	5-16
5.4.6	Ground Servicing Connections and Capacities: Model 737, All Models	5-17
5.5	ENGINE STARTING PNEUMATIC REQUIREMENTS	5-19
5.5.1	Engine Start Pneumatic Requirements - Sea Level: Model 737-100, -200	5-19
5.5.2	Engine Start Pneumatic Requirements - Sea Level: Model 737-300, -400, -500	5-20
5.6	GROUND PNEUMATIC POWER REQUIREMENTS	5-21
5.6.1	Ground Pneumatic Power Requirements - Heating/Cooling: Model 737-100, -200	5-21
5.6.2	Ground Pneumatic Power Requirements - Heating/Cooling: Model 737-300, -500	5-22
5.6.3	Ground Pneumatic Power Requirements - Heating/Cooling: Model 737-400	5-23
5.7	CONDITIONED AIR REQUIREMENTS	5-24

5.7.1	Conditioned Air Flow Requirements: Model 737-100, -200	5-24
5.7.2	Conditioned Air Flow Requirements: Model 737-300, -500	5-25
5.7.3	Conditioned Air Flow Requirements: Model 737-400	5-26
5.8	GROUND TOWING REQUIREMENTS	5-27
5.8.1	Ground Towing Requirements - English Units: Model 737, All Models.....	5-27
5.8.2	Ground Towing Requirements - Metric Units: Model 737, All Models.....	5-28
6.0	JET ENGINE WAKE AND NOISE DATA	6-1
6.1	JET ENGINE EXHAUST VELOCITIES AND TEMPERATURES	6-1
6.1.1	Jet Engine Exhaust Velocity Contours – Idle Thrust: Model 737- 100, -200	6-2
6.1.2	Jet Engine Exhaust Velocity Contours – Idle Thrust: Model 737- 300, -400, -500	6-3
6.1.3	Jet Engine Exhaust Velocity Contours - Breakaway Thrust: Model 737-100, -200	6-4
6.1.4	Jet Engine Exhaust Velocity Contours - Breakaway Thrust: Model 737-300, -400, -500.....	6-5
6.1.5	Jet Engine Exhaust Velocity Contours - Takeoff Thrust: Model 737-100, -200	6-6
6.1.6	Jet Engine Exhaust Velocity Contours - Takeoff Thrust: Model 737-300, -400, -500.....	6-7
6.1.7	Jet Engine Exhaust Temperature Contours - Idle Thrust: Model 737-100, -200	6-8
6.1.8	Jet Engine Exhaust Temperature Contours - Idle Thrust: Model 737-300, -400, -500.....	6-9
6.1.9	Jet Engine Exhaust Temperature Contours – Breakaway Thrust: Model 737-100, -200.....	6-10
6.1.10	Jet Engine Exhaust Temperature Contours – Breakaway Thrust: Model 737-300, -400, -500	6-11
6.1.11	Jet Engine Exhaust Temperature Contours – Takeoff Thrust: Model 737-100, -200.....	6-12
6.1.12	Jet Engine Exhaust Temperature Contours – Takeoff Thrust: Model 737-300, -400, -500	6-13
6.2	AIRPORT AND COMMUNITY NOISE.....	6-14
7.0	PAVEMENT DATA	7-1
7.1	GENERAL INFORMATION.....	7-1
7.2	LANDING GEAR FOOTPRINT	7-3
7.2.1	Landing Gear Footprint: Model 737-100.....	7-3
7.2.2	Landing Gear Footprint: Model 737-200.....	7-4
7.2.3	Landing Gear Footprint: Model Advanced 737-200.....	7-5
7.2.4	Landing Gear Footprint: Model Advanced 737-300, -400, -500.....	7-6

7.3	MAXIMUM PAVEMENT LOADS.....	7-7
7.3.1	Maximum Pavement Loads: Model 737-100, -200	7-7
7.3.2	Maximum Pavement Loads: Model 737-300, -400, -500	7-8
7.4	LANDING GEAR LOADING ON PAVEMENT	7-9
7.4.1	Landing Gear Loading on Pavement: Model 737-100.....	7-9
7.4.2	Landing Gear Loading on Pavement: Model 737-200.....	7-10
7.4.3	Landing Gear Loading on Pavement: Model 737-200 Advanced	7-11
7.4.4	Landing Gear Loading on Pavement: Model 737-300.....	7-12
7.4.5	Landing Gear Loading on Pavement: Model 737-400.....	7-13
7.4.6	Landing Gear Loading on Pavement: 737-500	7-14
7.5	FLEXIBLE PAVEMENT REQUIREMENTS - U.S. ARMY CORPS OF ENGINEERS METHOD S-77-1 AND FAA DESIGN METHOD.....	7-15
7.5.1	Flexible Pavement Requirements - U.S. Army Corps of Engineers Design Method (S-77-1) and FAA Design Method: Model 737-100, -200 to 104,000 LB (47,170 KG) MTW	7-16
7.5.2	Flexible Pavement Requirements - U.S. Army Corps of Engineers Design Method (S-77-1) and FAA Design Method: Model 737-100, -200, -200 ADV at 110,000 to 117,500 LB (49,895 to 53,297 KG) MTW	7-17
7.5.3	Flexible Pavement Requirements - U.S. Army Corps of Engineers Design Method (S-77-1) and FAA Design Method: Model 737-200 ADV at 116,000 to 117,500 LB (52,617 to 53,297 KG) MTW, Low Pressure Tires.....	7-18
7.5.4	Flexible Pavement Requirements - U.S. Army Corps of Engineers Design Method (S-77-1) and FAA Design Method: Model 737-200 ADV at 120,000 to 128,600 LB (54,431 to 58,332 KG) MTW....	7-19
7.5.5	Flexible Pavement Requirements - U.S. Army Corps of Engineers Design Method (S-77-1) and FAA Design Method: Model 737-300, -400, -500.....	7-20
7.6	FLEXIBLE PAVEMENT REQUIREMENTS - LCN CONVERSION.....	7-21
7.6.1	Flexible Pavement Requirements - LCN Method: Model 737-100, -200 at 140,000 LB (47,174 KG) MTW	7-22
7.6.2	Flexible Pavement Requirements - LCN Method: Model 737-100, -200, -200 ADV at 110,000 to 117,500 LB (49,895 to 53,297 KG) MTW	7-23
7.6.3	Flexible Pavement Requirements - LCN Method: Model 737-200 ADV at 116,000 to 117,500 LB (52,617 to 53,297 KG) MTW, Low Pressure Tires.....	7-24
7.6.4	Flexible Pavement Requirements - LCN Method: Model 737-200 ADV at 120,000 to 128,600 LB (54,431 to 58,332 KG) MTW.....	7-25
7.6.5	Flexible Pavement Requirements - LCN Method: Model 737-300, -400, -500	7-26

7.7	RIGID PAVEMENT REQUIREMENTS - PORTLAND CEMENT ASSOCIATION DESIGN METHOD	7-27
7.7.1	Rigid Pavement Requirements - Portland Cement Association Design Method: Model 737-100, 200 to 104,000 LB (47,170KG) MTW	7-28
7.7.2	Rigid Pavement Requirements - Portland Cement Association Design Method: Model 737-100, -200, -200ADV at 110,000 to 117,500 LB (49,900 to 53,290 KG) MTW	7-29
7.7.3	Rigid Pavement Requirements - Portland Cement Association Design Method: Model 737-200ADV at 116,000 to 117,500 LB (52,610 to 53,290 KG) MTW (LOW PRESSURE TIRES).....	7-30
7.7.4	Rigid Pavement Requirements - Portland Cement Association Design Method: Model 737-200ADV at 120,000 to 128,000 LB (54,430 to 58,330 KG) MTW	7-31
7.7.5	Rigid Pavement Requirements - Portland Cement Association Design Method: Model 737-300, -400, -500	7-32
7.7.6	Rigid Pavement Requirements - Portland Cement Association Design Method: Model 737-300, -400, -500 (Low Pressure Tires).....	7-33
7.8	RIGID PAVEMENT REQUIREMENTS - LCN CONVERSION	7-34
7.8.1	Radius of Relative Stiffness (Reference: Portland Cement Association)	7-35
7.8.2	Rigid Pavement Requirements - LCN Conversion: Model 737-100, -200 to 104,000 LB (47,170 KG) MTW	7-36
7.8.3	Rigid Pavement Requirements - LCN Conversion: Model 737-100, -200 at 110,000 to 117,500 LB (49,900 to 53,290 KG) MTW	7-37
7.8.4	Rigid Pavement Requirements - LCN Conversion: Model 737-200ADV at 116,000 to 117,500 LB (52,610 to 53,290 KG) MTW (Low Pressure Tires)	7-38
7.8.5	Rigid Pavement Requirements - LCN Conversion: Model 737-200ADV at 120,000 to 128,600 LB (54,430 to 58,330 KG) MTW	7-39
7.8.6	Rigid Pavement Requirements - LCN Conversion: Model 737-300, -400, -500	7-40
7.9	RIGID PAVEMENT REQUIREMENTS - FAA DESIGN METHOD	7-41
7.9.1	Rigid Pavement Requirements – FAA Design Method: Model 737-100, -200	7-42
7.9.2	Rigid Pavement Requirements – FAA Design Method: Model 737-200ADV (Low Pressure Tires)	7-43
7.9.3	Rigid Pavement Requirements – FAA Design Method: Model 737-300, -400, -500	7-44
7.9.4	Rigid Pavement Requirements – FAA Design Method: Model 737-300, -400, -500 (Low Pressure Tires)	7-45
7.10	ACN/PCN REPORTING SYSTEM - FLEXIBLE AND RIGID PAVEMENTS	7-46

7.10.1	Aircraft Classification Number - Flexible Pavement: Model 737-100, -200 to 104,000 LB (47,170 KG) MTW	7-47
7.10.2	Aircraft Classification Number - Flexible Pavement: Model 737-100, -200, -200ADV at 110,000 to 117,500 LB (49,900 to 53,290 KG) MTW	7-48
7.10.3	Aircraft Classification Number - Flexible Pavement: Model 737-100, -200, -200ADV at 110,000 to 117,500 LB (49,900 to 53,290 KG) MTW (Low Pressure Tires)	7-49
7.10.4	Aircraft Classification Number - Flexible Pavement: Model 737-200ADV at 120,000 to 128,600 LB (54,300 to 58,330 KG) MTW	7-50
7.10.5	Aircraft Classification Number - Flexible Pavement: Model 737-300.....	7-51
7.10.6	Aircraft Classification Number - Flexible Pavement: Model 737-300 (Low Pressure Tires)	7-52
7.10.7	Aircraft Classification Number - Flexible Pavement: Model 737-400.....	7-53
7.10.8	Aircraft Classification Number - Flexible Pavement: Model 737-400 (Low Pressure Tires)	7-54
7.10.9	Aircraft Classification Number - Flexible Pavement: Model 737-500.....	7-55
7.10.10	Aircraft Classification Number - Flexible Pavement: Model 737-500 (Low Pressure Tires)	7-56
7.10.11	Aircraft Classification Number - Rigid Pavement: Model 737-100, -200 To 104,000 LB (47,170 KG) MTW.....	7-57
7.10.12	Aircraft Classification Number - Rigid Pavement: Model 737-100, -200, -200ADV at 110,000 to 117,500 LB (49,900 to 53,290 KG) MTW	7-58
7.10.13	Aircraft Classification Number - Rigid Pavement: Model 737-100, -200, -200ADV at 110,000 to 117,500 LB (49,900 to 53,290 KG) MTW (Low Pressure Tires)	7-59
7.10.14	Aircraft Classification Number - Rigid Pavement: Model 737-200ADV at 120,000 to 128,600 LB (54,300 to 58,330 KG) MTW.....	7-60
7.10.15	Aircraft Classification Number - Rigid Pavement: Model 737-300	7-61
7.10.16	Aircraft Classification Number - Rigid Pavement: Model 737-300 (Low Pressure Tires)	7-62
7.10.17	Aircraft Classification Number - Rigid Pavement: Model 737-400	7-63
7.10.18	Aircraft Classification Number - Rigid Pavement: Model 737-400 (Low Pressure Tires)	7-64
7.10.19	Aircraft Classification Number - Rigid Pavement: Model 737-500	7-65
7.10.20	Aircraft Classification Number - Rigid Pavement: Model 737-500 (Low Pressure Tires)	7-66
7.11	TIRE INFLATION CHART.....	7-67

7.11.1	Tire Inflation Chart: Model 737-100.....	7-67
7.11.2	Tire Inflation Chart: Model 737-100, -200	7-68
7.11.3	Tire Inflation Chart: Model ADV 737-200.....	7-69
7.11.4	Tire Inflation Chart: Model 737-200 (Low Pressure Tires).....	7-70
7.11.5	Tire Inflation Chart: Model 737-300.....	7-71
7.11.6	Tire Inflation Chart: Model 737-400.....	7-72
7.11.7	Tire Inflation Chart: Model 737-500.....	7-73
8.0	FUTURE 737 DERIVATIVE AIRPLANES.....	8-1
9.0	SCALED 737 DRAWINGS	9-1
9.1	MODEL 737-100.....	9-2
9.1.1	Scaled Drawings – 1 IN. = 32 FT: Model 737-100.....	9-2
9.1.2	Scaled Drawings – 1 IN. = 32 FT: Model 737-100.....	9-3
9.1.3	Scaled Drawings – 1 IN. = 50 FT: Model 737-100.....	9-4
9.1.4	Scaled Drawings – 1 IN. = 50 FT: Model 737-100.....	9-5
9.1.5	Scaled Drawings – 1 IN. = 100 FT: Model 737-100.....	9-6
9.1.6	Scaled Drawings – 1 IN. = 100 FT: Model 737-100.....	9-7
9.1.7	Scaled Drawings – 1:500: Model 737-100.....	9-8
9.1.8	Scaled Drawings – 1:500: Model 737-100.....	9-9
9.1.9	Scaled Drawings – 1:1000: Model 737-100.....	9-10
9.1.10	Scaled Drawings – 1:1000: Model 737-100.....	9-11
9.2	MODEL 737-200.....	9-12
9.2.1	Scaled Drawings – 1 IN. = 32 FT: Model 737-200.....	9-12
9.2.2	Scaled Drawings – 1 IN. = 32 FT: Model 737-200.....	9-13
9.2.3	Scaled Drawings – 1 IN. = 50 FT: Model 737-200.....	9-14
9.2.4	Scaled Drawings – 1 IN. = 50 FT: Model 737-200.....	9-15
9.2.5	Scaled Drawings – 1 IN. = 100 FT: Model 737-200.....	9-16
9.2.6	Scaled Drawings – 1 IN. = 100 FT: Model 737-200.....	9-17
9.2.7	Scaled Drawings – 1:500: Model 737-200.....	9-18
9.2.8	Scaled Drawings – 1:500: Model 737-200.....	9-19
9.2.9	Scaled Drawings – 1:1000: Model 737-200.....	9-20
9.2.10	Scaled Drawings – 1:1000: Model 737-200.....	9-21
9.3	MODEL 737-300.....	9-22
9.3.1	Scaled Drawings – 1 IN. = 32 FT: Model 737-300.....	9-22
9.3.2	Scaled Drawings – 1 IN. = 32 FT: Model 737-300.....	9-23
9.3.3	Scaled Drawings – 1 IN. = 50 FT: Model 737-300.....	9-24
9.3.4	Scaled Drawings – 1 IN. = 50 FT: Model 737-300.....	9-25
9.3.5	Scaled Drawings – 1 IN. = 100 FT: Model 737-300.....	9-26
9.3.6	Scaled Drawings – 1 IN. = 100 FT: Model 737-300.....	9-27
9.3.7	Scaled Drawings – 1:500: Model 737-300.....	9-28
9.3.8	Scaled Drawings – 1:500: Model 737-300.....	9-29

9.3.9	Scaled Drawings – 1:1000: Model 737-300.....	9-30
9.3.10	Scaled Drawings – 1:1000: Model 737-300.....	9-31
9.4	MODEL 737-300W	9-32
9.4.1	Scaled Drawings – 1 IN. = 32 FT: Model 737-300W	9-32
9.4.2	Scaled Drawings – 1 IN. = 32 FT: Model 737-300W	9-33
9.4.3	Scaled Drawings – 1 IN. = 50 FT: Model 737-300W	9-34
9.4.4	Scaled Drawings – 1 IN. = 50 FT: Model 737-300W	9-35
9.4.5	Scaled Drawings – 1 IN. = 100 FT: Model 737-300W	9-36
9.4.6	Scaled Drawings – 1 IN. = 100 FT: Model 737-300W	9-37
9.4.7	Scaled Drawings – 1:500: Model 737-300W	9-38
9.4.8	Scaled Drawings – 1:500: Model 737-300W	9-39
9.4.9	Scaled Drawings – 1:1000: Model 737-300W	9-40
9.4.10	Scaled Drawings – 1:1000: Model 737-300W	9-41
9.5	MODEL 737-400.....	9-42
9.5.1	Scaled Drawings – 1 IN. = 32 FT: Model 737-400.....	9-42
9.5.2	Scaled Drawings – 1 IN. = 32 FT: Model 737-400.....	9-43
9.5.3	Scaled Drawings – 1 IN. = 50 FT: Model 737-400.....	9-44
9.5.4	Scaled Drawings – 1 IN. = 50 FT: Model 737-400.....	9-45
9.5.5	Scaled Drawings – 1 IN. = 100 FT: Model 737-400.....	9-46
9.5.6	Scaled Drawings – 1 IN. = 100 FT: Model 737-400.....	9-47
9.5.7	Scaled Drawings – 1:500: Model 737-400.....	9-48
9.5.8	Scaled Drawings – 1:500: Model 737-400.....	9-49
9.5.9	Scaled Drawings – 1:1000: Model 737-400.....	9-50
9.5.10	Scaled Drawings – 1:1000: Model 737-400.....	9-51
9.6	MODEL 737-500.....	9-52
9.6.1	Scaled Drawings – 1 IN. = 32 FT: Model 737-500.....	9-52
9.6.2	Scaled Drawings – 1 IN. = 32 FT: Model 737-500.....	9-53
9.6.3	Scaled Drawings – 1 IN. = 50 FT: Model 737-500.....	9-54
9.6.4	Scaled Drawings – 1 IN. = 50 FT: Model 737-500.....	9-55
9.6.5	Scaled Drawings – 1 IN. = 100 FT: Model 737-500.....	9-56
9.6.6	Scaled Drawings – 1 IN. = 100 FT: Model 737-500.....	9-57
9.6.7	Scaled Drawings – 1:500: Model 737-500.....	9-58
9.6.8	Scaled Drawings – 1:500: Model 737-500.....	9-59
9.6.9	Scaled Drawings – 1:1000: Model 737-500.....	9-60
9.6.10	Scaled Drawings – 1:1000: Model 737-500.....	9-61

1.0 SCOPE AND INTRODUCTION

1.1 SCOPE

This document provides, in a standardized format, airplane characteristics data for general airport planning. Since operational practices vary among airlines, specific data should be coordinated with the using airlines prior to facility design. Boeing Commercial Airplanes should be contacted for any additional information required.

Content of the document reflects the results of a coordinated effort by representatives from the following organizations:

- Aerospace Industries Association
- Airports Council International - North America
- Air Transport Association of America
- International Air Transport Association

The airport planner may also want to consider the information presented in the "Commercial Aircraft Design Characteristics - Trends and Growth Projections," for long range planning needs and can be accessed via the following website:

<http://www.boeing.com/airports>

The document is updated periodically and represents the coordinated efforts of the following organizations regarding future aircraft growth trends.

- International Coordinating Council of Aerospace Industries Associations
- Airports Council International - North America
- Air Transport Association of America
- International Air Transport Association

1.2 INTRODUCTION

This document conforms to NAS 3601. It provides characteristics of the Boeing Model 737 Classic airplane for airport planners and operators, airlines, architectural and engineering consultant organizations, and other interested industry agencies. Airplane changes and available options may alter model characteristics. Data contained herein is generic in scope and not customer-specific.

For additional information contact:

Boeing Commercial Airplanes
2201 Seal Beach Blvd. M/C: 110-SB02
Seal Beach, CA 90740-1515
U.S.A.

Attention: Manager, Airport Operations Engineering

Email: AirportCompatibility@boeing.com

1.3 A BRIEF DESCRIPTION OF THE 737 FAMILY OF AIRPLANES

The 737 is a twin-engine airplane designed to operate over short to medium ranges from sea level runways of less than 6,000 ft (1,830 m) in length.

Significant features of interest to airport planners are described below:

- Underwing-mounted engines provide eye-level assessability. Nearly all system maintenance may be performed at eye level.
- Optional airstairs allow operation at airports where no passengers loading bridges or stairs are available.
- Auxiliary power unit can supply energy for engine starting, air conditioning, and electrical power while the airplane is on the ground or in flight.
- Servicing connections allow single-station pressure fueling and overwing gravity fueling.
- All servicing of the 737 is accomplished with standard ground equipment.

737-100

The 737-100 is the standard short body version of the 737 family. It is 94 ft (28.63 m) long from nose to the tip of the horizontal stabilizer.

737-200

The 737-200 is an extended body version of the 737 family and is 100 ft 2 in (30.53 m) long. Two sections were added to the 737-100 fuselage; a 36-in section forward of the wing and a 40-in section aft of the wing. All other dimensions are the same as the 737-100.

Advanced 737-200

The advanced 737-200 is a high gross weight airplane that has significant improvements over the 737-200, which result in improved performance, e.g. longer range, greater payload, and shorter runway requirement. The advanced 737-200 has dimensions identical to the 737-200.

737-200C, Adv 737-200C

The convertible version differs from the passenger model in that it has an 86 by 134-in (2.18 by 3.40 m) main deck cargo door, increased floor strength, and additional seat tracks. Either of two cargo handling systems, the cargo (C) or quick change (QC) can be installed to allow conversion from a passenger configuration to a cargo or a mixed passenger/cargo configuration, and vice-versa.

737-200 Executive Airplane

The 737-200 and Adv 737-200 were also delivered with an executive interior. The interior comes in a variety of configurations depending on customer requirements. Some airplanes were delivered without any interior furnishings for customer installation of special interiors.

737-300

The 737-300 is a second-generation stretched version of the 737 family of airplanes and is 109 ft 7 in long. Two sections were added to the 737-200 fuselage; a 44-in section forward of the wing and a 60-in section aft of the wing. Wing and stabilizer spans are also increased. The 737-300 incorporates new aerodynamic and engine technologies in addition to the increased payload and range. The -300 can seat as many as 149 passengers in an all-economy configuration.

737-300 With Winglets

Winglets are installed on some 737-300 airplanes as an after-market airline option. Data for this airplane is included for dimensional information only.

737-400

The 737-400 is 120 inches longer than the -300. Two sections were added to the -300 fuselage; a 72-in section forward of the wing and a 48-in section aft of the wing. The -400 can seat as many as 168 passengers in all-economy configuration.

737-500

The 737-500 is the shortened version of the 737-300. The -500 is 101 ft 9 in long and can seat up to 132 passengers in an all-economy configuration.

Engines

The 737-100 and -200 airplanes were equipped with JT8D-7 engines. The -9, -5, -17, and -17R engines reflect successive improvements in noise reduction, thrust, and maintenance costs. Other optional engines include the -9A, -15A, -17A, and -17AR.

The 737-300, -400, and -500 airplanes are equipped with new high bypass ratio engines (CFM56-3) that are economical to operate and maintain. These are quiet engines that meet FAR 36 Stage 3 and ICAO Annex 16 Chapter 3 noise standards. With these higher thrust engines and modified flight control surfaces, runway length requirement is reduced.

737 Gravel Runway Capability

The optional gravel runway capability allows the 737-200 to operate on remote unimproved runways. The gravel kit includes gravel deflectors for the nose and main

gears, vortex dissipators for each engine nacelle, and special protective finishes. Low-pressure tires are also required for operation on low strength runways.

The special environment of the gravel runway dictates changes in operating procedures and techniques for maximum safety and economy. Boeing Commercial Airplanes and the FAA have specified procedural changes for operating the 737-200 on gravel runways. Organizations interested in operational details are referred to the using airline or to Boeing.

Passenger Cabin Interiors

Early 737s were equipped with hat-rack-type overhead stowage. Later models were equipped with a “wide-body look” interior that incorporates stowage bins in the sidewall and ceiling panels to simulate a superjet interior. More recent configurations include carryall compartments and the advanced technology interior. These interiors provide more stowage above the passenger seats.

Integral Airstairs

Optional airstairs allow passenger loading and unloading at airports where there are no loading bridges or stairs. The forward airstairs are mounted under the cabin floor just below the forward entry door. The aft airstairs are mounted on a special aft entry door and are deployed when the door is opened. The aft airstairs option is available only on the 737-100 and 737-200 airplanes.

Auxiliary Fuel Tanks

Optional auxiliary fuel tanks installed in the lower cargo compartments, provide extra range capability. Although this option increases range, it decreases payload.

Document Page Applicability

Several configurations have been developed for the 737 family of airplanes to meet varied airline requirements. Configurations shown in this document are typical and individual airlines may have different combinations of options. The airlines should be consulted for specific airplane configuration.

Document Applicability

This document contains information on all 737CL models.

Information on the 737-100, -200, 200C, Adv 737-200, and Adv 737-200C formerly contained in Document D6-58325, Revision D, 737 Airplane Characteristics for Airport Planning is now included in this document. Document D6-58325 is superseded and should be discarded.

Information on the 737-300, -400, and -500 model airplanes formerly contained in Document D6-58325-2 Revision A, 737-300/400/500 Airplane Characteristics for

Airport Planning is now included in this document. Document D6-58325-2 is superseded and should be discarded.

2.0 AIRPLANE DESCRIPTION

2.1 GENERAL CHARACTERISTICS

Maximum Design Taxi Weight (MTW). Maximum weight for ground maneuver as limited by aircraft strength and airworthiness requirements. (It includes weight of taxi and run-up fuel.)

Maximum Design Takeoff Weight (MTOW). Maximum weight for takeoff as limited by aircraft strength and airworthiness requirements. (This is the maximum weight at start of the takeoff run.)

Maximum Design Landing Weight (MLW). Maximum weight for landing as limited by aircraft strength and airworthiness requirements.

Maximum Design Zero Fuel Weight (MZFW). Maximum weight allowed before usable fuel and other specified usable agents must be loaded in defined sections of the aircraft as limited by strength and airworthiness requirements.

Operating Empty Weight (OEW). Weight of structure, powerplant, furnishing systems, unusable fuel and other unusable propulsion agents, and other items of equipment that are considered an integral part of a particular airplane configuration. Also included are certain standard items, personnel, equipment, and supplies necessary for full operations, excluding usable fuel and payload.

Maximum Payload. Maximum design zero fuel weight minus operational empty weight.

Maximum Seating Capacity. The maximum number of passengers specifically certificated or anticipated for certification.

Maximum Cargo Volume. The maximum space available for cargo.

Usable Fuel. Fuel available for aircraft propulsion.

2.1.1 General Characteristics: Model 737-100

CHARACTERISTICS	UNITS	MODEL 737-100		
MAX DESIGN - TAXI WEIGHT	POUNDS	97,800	104,000	111,000
	KILOGRAMS	44,361	47,174	50,349
MAX DESIGN - TAKEOFF WEIGHT	POUNDS	97,000	103,000	110,000
	KILOGRAMS	43,998	46,720	49,895
MAX DESIGN - LANDING WEIGHT	POUNDS	89,700	98,000	99,000
	KILOGRAMS	40,687	44,452	44,906
MAX DESIGN - ZERO FUEL WEIGHT	POUNDS	81,700	85,000	90,000
	KILOGRAMS	37,058	38,555	40,823
OPERATING - EMPTY WEIGHT (1)	POUNDS	58,600	59,000	62,000
	KILOGRAMS	26,581	26,762	28,123
MAX STRUCTURAL - PAYLOAD (1)	POUNDS	23,100	26,000	28,000
	KILOGRAMS	10,478	11,793	12,701
SEATING CAPACITY (1)	TWO-CLASS	85: 12 FIRST CLASS AND 73 ECONOMY		
	ALL-ECONOMY	96 AT SIX ABREAST; FAA EXIT LIMIT: 124		
MAX CARGO VOLUME - LOWER DECK	CUBIC FEET	650	650	650
	CUBIC METERS	18.4	18.4	18.4
USABLE FUEL	US GALLONS	3,540	3,540	4,720
	LITERS	13,399	13,399	17,865
	POUNDS	23,718	23,718	31,624
	KILOGRAMS	10,758	10,758	14,345

NOTE:

1. OPERATING EMPTY WEIGHT FOR BASELINE MIXED CLASS CONFIGURATION. CONSULT WITH AIRLINE FOR SPECIFIC WEIGHTS AND CONFIGURATIONS.

2.1.2 General Characteristics: Model 737-200

CHARACTERISTICS	UNITS	MODEL 737-200				
MAX DESIGN - TAXI WEIGHT	POUNDS	100,800	104,000	110,000	111,000	116,000
	KILOGRAMS	45,722	47,174	49,895	50,349	52,617
MAX DESIGN - TAKEOFF WEIGHT	POUNDS	100,000	103,000	109,000	110,000	115,500
	KILOGRAMS	45,359	46,720	49,442	49,895	52,390
MAX DESIGN - LANDING WEIGHT	POUNDS	95,000	95,000	98,000	99,000	103,000
	KILOGRAMS	43,091	43,091	44,452	44,906	46,720
MAX DESIGN - ZERO FUEL WEIGHT	POUNDS	85,000	85,000	88,000	92,000	95,000
	KILOGRAMS	38,555	38,555	39,916	41,731	43,091
OPERATING - EMPTY WEIGHT (1)	POUNDS	59,900	60,900	60,800	61,800	59,800
	KILOGRAMS	27,170	27,624	27,578	28,032	27,125
MAX STRUCTURAL - PAYLOAD (1)	POUNDS	25,100	24,100	27,200	30,200	35,200
	KILOGRAMS	11,385	10,932	12,338	13,698	15,966
SEATING CAPACITY (1)	TWO-CLASS	97: 24 FIRST CLASS AND 73 ECONOMY				
	ALL-ECONOMY	90 AT FIVE ABREAST, OR 124 AT SIX ABREAST; FAA EXIT LIMIT: 136				
MAX CARGO VOLUME - LOWER DECK	CUBIC FEET	875	875	875	875	875
	CUBIC METERS	24.8	24.8	24.8	24.8	24.8
USABLE FUEL	U.S. GALLONS	3,460	4,190	4,230	4,780	4,780
	LITERS	13,096	15,859	16,011	18,092	18,092
	POUNDS	23,182	28,073	28,341	32,026	32,026
	KILOGRAMS	10,515	12,734	12,855	14,527	14,527

NOTE:

1. OPERATING EMPTY WEIGHT FOR BASELINE MIXED CLASS CONFIGURATION. CONSULT WITH AIRLINE FOR SPECIFIC WEIGHTS AND CONFIGURATIONS.

2.1.3 General Characteristics: Model 737-200

CHARACTERISTICS	UNITS	MODEL 737-200				
MAX DESIGN - TAXI WEIGHT	POUNDS	116,000	117,500	120,000	125,000	128,600
	KILOGRAMS	52,617	53,297	54,431	56,699	58,332
MAX DESIGN - TAKEOFF WEIGHT	POUNDS	115,500	117,000	119,500	124,500	128,100
	KILOGRAMS	52,390	53,070	54,204	56,472	58,105
MAX DESIGN - LANDING WEIGHT	POUNDS	103,000	105,000	105,000	107,000	107,000
	KILOGRAMS	46,720	47,627	47,627	48,534	48,534
MAX DESIGN - ZERO FUEL WEIGHT	POUNDS	95,000	95,000	95,000	95,000	95,000
	KILOGRAMS	43,091	43,091	43,091	43,091	43,091
OPERATING - EMPTY WEIGHT (1)	POUNDS	62,600	64,500	63,100	63,900	65,300
	KILOGRAMS	28,395	29,257	28,622	28,985	29,620
MAX STRUCTURAL - PAYLOAD	POUNDS	32,400	30,500	31,900	31,100	29,700
	KILOGRAMS	14,696	13,835	14,470	14,107	13,472
SEATING CAPACITY (1)	TWO-CLASS	102: 14 FIRST CLASS AND 88 ECONOMY				
	ALL-ECONOMY	93 AT FIVE ABREAST, OR 130 AT SIX ABREAST; FAA EXIT LIMIT: 136				
MAX CARGO VOLUME - LOWER DECK	CUBIC FEET	875	875	875	745 (2)	640 (3)
	CUBIC METERS	24.8	24.8	24.8	21.1 (2)	18.1 (3)
USABLE FUEL	U.S. GALLONS	5,160	5,160	5,160	5,550 (2)	5,970 (3)
	LITERS	19,531	19,531	19,531	21,007 (2)	22,596 (3)
	POUNDS	34,572	34,572	34,572	37,185 (2)	39,999 (3)
	KILOGRAMS	15,682	15,682	15,682	16,867 (2)	18,143 (3)

NOTES:

1. OPERATING EMPTY WEIGHT FOR BASELINE MIXED CLASS CONFIGURATION. CONSULT WITH AIRLINE FOR SPECIFIC WEIGHTS AND CONFIGURATIONS.
2. AIRPLANE WITH 390 GAL (1,475 L) AUXILIARY FUEL TANK IN AFT CARGO COMPARTMENT
3. AIRPLANE WITH 810 GAL (3,065 L) AUXILIARY FUEL TANK IN AFT CARGO COMPARTMENT

2.1.4 General Characteristics: Model 737-200, Convertible and Executive Airplanes

CHARACTERISTICS	UNITS	MODEL 737-200				
		CONVERTIBLE				EXECUTIVE
MAX DESIGN - TAXI WEIGHT	POUNDS	110,000	111,000	111,000	116,000	116,000
	KILOGRAMS	49,895	50,349	50,349	52,617	52,617
MAX DESIGN - TAKEOFF WEIGHT	POUNDS	109,000	110,000	110,000	115,500	115,500
	KILOGRAMS	49,442	49,895	49,895	52,390	52,390
MAX DESIGN - LANDING WEIGHT	POUNDS	98,000	99,000	103,000	103,000	103,000
	KILOGRAMS	44,452	44,906	46,720	46,720	46,720
MAX DESIGN - ZERO FUEL WEIGHT	POUNDS	88,000	92,000	95,000	95,000	95,000
	KILOGRAMS	39,916	41,731	43,091	43,091	43,091
OPERATING - EMPTY WEIGHT (1)	POUNDS	61,100	64,900	69,700	66,800	54,900
	KILOGRAMS	27,714	29,438	31,615	30,300	24,902
MAX STRUCTURAL - PAYLOAD	POUNDS	26,900	27,100	25,300	28,200	40,100
	KILOGRAMS	12,202	12,292	11,476	12,791	18,189
SEATING CAPACITY (1)	TWO-CLASS	110: 8 FIRST CLASS AND 102 ECONOMY (2)				EXECUTIVE INTERIOR VARIES WITH CUSTOMER OPTION
	ALL-ECONOMY	117 AT SIX ABREAST (2) ; FAA EXIT LIMIT: 136				
MAX CARGO VOLUME - MAIN DECK	CUBIC FEET	2,760 (3)	2,760 (3)	2,760 (3)	2,760 (3)	
	CUBIC METERS	78.2 (3)	78.2 (3)	78.2 (3)	78.2 (3)	
MAX CARGO VOLUME - LOWER DECK	CUBIC FEET	875	875	875	875	875
	CUBIC METERS	24.8	24.8	24.8	24.8	24.8
USABLE FUEL	U.S. GALLONS	4,200	4,750	3,500	4,780	4,720
	LITERS	15,897	17,979	13,248	18,092	17,865
	POUNDS	28,140	31,825	23,450	32,026	31,624
	KILOGRAMS	12,764	14,436	10,637	14,527	14,345

NOTES:

1. OPERATING EMPTY WEIGHT FOR BASELINE MIXED CLASS CONFIGURATION. CONSULT WITH AIRLINE FOR SPECIFIC WEIGHTS AND CONFIGURATIONS.
2. AIRPLANE IN ALL-PASSENGER CONFIGURATION
3. AIRPLANE IN ALL-CARGO CONFIGURATION WITH THE "QC" CARGO SYSTEM 88 x 125 IN (2.24 x 3.18 M) PALLETS

2.1.5 General Characteristics: Model Advanced 737-200C, -200QC

CHARACTERISTICS	UNITS	MODEL 737-200C, -200QC				
MAX DESIGN - TAXI WEIGHT	POUNDS	116,000	117,500	120,000	125,000	128,600
	KILOGRAMS	52,617	53,297	54,431	56,699	58,332
MAX DESIGN - TAKEOFF WEIGHT	POUNDS	115,500	117,000	119,500	124,500	128,100
	KILOGRAMS	52,390	53,070	54,204	56,472	58,105
MAX DESIGN - LANDING WEIGHT	POUNDS	103,000	105,000	105,000	107,000	107,000
	KILOGRAMS	46,720	47,627	47,627	48,534	48,534
MAX DESIGN - ZERO FUEL WEIGHT	POUNDS	95,000	96,500	95,000	99,000	99,000
	KILOGRAMS	43,091	43,772	43,091	44,906	44,906
OPERATING - EMPTY WEIGHT (1)	POUNDS	65,700	69,800	66,500	67,000	65,700
	KILOGRAMS	29,801	31,661	30,164	30,391	29,801
MAX STRUCTURAL - PAYLOAD	POUNDS	29,300	26,700	28,500	32,000	33,300
	KILOGRAMS	13,290	12,111	12,927	14,515	15,105
SEATING CAPACITY (2)	TWO-CLASS	102: 14 FIRST CLASS AND 88 ECONOMY				
	ALL-ECONOMY	93 AT FIVE ABREAST, OR 130 AT SIX ABREAST; FAA EXIT LIMIT: 136				
MAX CARGO VOLUME - MAIN DECK (3)	CUBIC FEET	2,760	2,760	2,760	2,760	2,760
	CUBIC METERS	78.2	78.2	78.2	78.2	78.2
MAX CARGO VOLUME - LOWER DECK	CUBIC FEET	875	875	875	875	875
	CUBIC METERS	24.8	24.8	24.8	24.8	24.8
USABLE FUEL	U.S. GALLONS	5,160	5,160	5,160	5,160	5,160
	LITERS	19,531	19,531	19,531	19,531	19,531
	POUNDS	34,572	34,572	34,572	34,572	34,572
	KILOGRAMS	15,682	15,682	15,682	15,682	15,682

NOTES:

1. OPERATING EMPTY WEIGHT FOR BASELINE MIXED CLASS CONFIGURATION. CONSULT WITH AIRLINE FOR SPECIFIC WEIGHTS AND CONFIGURATIONS.
2. AIRPLANE IN ALL-PASSENGER CONFIGURATION
3. AIRPLANE IN ALL-CARGO CONFIGURATION, SEVEN PALLETS 88 x 125 IN (2.24 x 3.18 M) EACH

2.1.6 General Characteristics: Model 737-300

CHARACTERISTICS	UNITS	MODEL 737-300					
		CFM56-3B1 ENGINES (20,000 LB SLST)			CFM56-3B2 ENGINES (22,000 LB SLST)		
MAX DESIGN - TAXI WEIGHT	POUNDS	125,000	130,500	135,500	137,500	140,000	140,000
	KILOGRAMS	56,699	59,194	61,462	62,369	63,503	63,503
MAX DESIGN - TAKEOFF WEIGHT	POUNDS	124,500	130,000	135,000	137,000	139,500	139,500
	KILOGRAMS	56,472	58,967	61,235	62,142	63,276	63,276
MAX DESIGN - LANDING WEIGHT	POUNDS	114,000	114,000	114,000	114,000	116,600	116,600
	KILOGRAMS	51,710	51,710	51,710	51,710	52,889	52,889
MAX DESIGN - ZERO FUEL WEIGHT	POUNDS	105,000	105,000	106,500	106,500	109,600	109,600
	KILOGRAMS	47,627	47,627	48,308	48,308	49,714	49,714
OPERATING - EMPTY WEIGHT (1)	POUNDS	69,400	71,870	72,540	72,540	72,540	72,540
	KILOGRAMS	31,479	32,600	32,904	32,904	32,904	32,904
MAX STRUCTURAL - PAYLOAD	POUNDS	35,600	33,130	33,960	33,960	33,960	33,960
	KILOGRAMS	16,148	15,028	15,404	15,404	15,404	15,404
SEATING CAPACITY	TWO-CLASS	128: 8 FIRST CLASS AND 120 ECONOMY					
	ALL-ECONOMY	134 AT SIX ABREAST; FAA EXIT LIMIT: 149					
MAX CARGO VOLUME - LOWER DECK	CUBIC FEET	1,068	929 (2)	841 (3)	917 (4)	792 (5)	792 (5)
	CUBIC METERS	30.2	26.3 (2)	23.8 (3)	26.0 (4)	22.4 (5)	22.4 (5)
USABLE FUEL	U.S. GALLONS	5,311	5,701 (2)	6,121 (3)	5,803 (4)	6,295 (5)	6,295 (5)
	LITERS	20,102	21,578 (2)	23,168 (3)	21,964 (4)	23,827 (5)	23,827 (5)
	POUNDS	35,584	38,197 (2)	41,011 (3)	38,880 (4)	42,177 (5)	42,177 (5)
	KILOGRAMS	16,141	17,326 (2)	18,602 (3)	17,636 (4)	19,131 (5)	19,131 (5)

NOTES:

1. OPERATING EMPTY WEIGHT FOR BASELINE MIXED CLASS CONFIGURATION. CONSULT WITH AIRLINE FOR SPECIFIC WEIGHTS AND CONFIGURATIONS.
2. AIRPLANE WITH 390 GAL (1,475 L) AUXILIARY FUEL TANK IN AFT CARGO COMPARTMENT
3. AIRPLANE WITH 810 GAL (3,065 L) AUXILIARY FUEL TANK IN AFT CARGO COMPARTMENT
4. AIRPLANE WITH 500 GAL (1,893 L) AUXILIARY FUEL TANK IN AFT CARGO COMPARTMENT
5. AIRPLANE WITH 1,000 GAL (3,785 L) AUXILIARY FUEL TANK IN AFT CARGO COMPARTMENT

2.1.7 General Characteristics: Model 737-400

CHARACTERISTICS	UNITS	MODEL 737-400					
		CFM56-3B2 ENGINES (22,000 LB SLST)			CFM56-3C ENGINES (23,500 LB SLST)		
MAX DESIGN - TAXI WEIGHT	POUNDS	139,000	143,000	150,500	143,000	144,000	150,500
	KILOGRAMS	63,049	64,864	68,266	64,864	65,317	68,266
MAX DESIGN - TAKEOFF WEIGHT	POUNDS	138,500	142,500	150,000	142,500	143,500	150,000
	KILOGRAMS	62,823	64,637	68,039	64,637	65,091	68,039
MAX DESIGN - LANDING WEIGHT	POUNDS	121,000	121,000	124,000	124,000	124,000	124,000
	KILOGRAMS	54,885	54,885	56,245	56,245	56,245	56,245
MAX DESIGN - ZERO FUEL WEIGHT	POUNDS	113,000	113,000	117,000	117,000	117,000	117,000
	KILOGRAMS	51,256	51,256	53,070	53,070	53,070	53,070
OPERATING - EMPTY WEIGHT (1)	POUNDS	73,170	73,170	73,170	74,170	74,170	74,170
	KILOGRAMS	33,189	33,189	33,189	33,643	33,643	33,643
MAX STRUCTURAL - PAYLOAD	POUNDS	39,830	39,830	43,830	42,830	42,830	42,830
	KILOGRAMS	18,067	18,067	19,881	19,427	19,427	19,427
SEATING CAPACITY	TWO-CLASS	146: 8 FIRST CLASS AND 138 ECONOMY					
	ALL-ECONOMY	159 AT SIX ABREAST; FAA EXIT LIMIT: 189					
MAX CARGO VOLUME - LOWER DECK	CUBIC FEET	1,373	1,234 (2)	1,146 (3)	1,222 (4)	1,097 (5)	1,097 (5)
	CUBIC METERS	38.9	34.9 (2)	32.5 (3)	34.6 (4)	31.1 (5)	31.1 (5)
USABLE FUEL	U.S. GALLONS	5,311	5,701 (2)	6,121 (3)	5,803 (4)	6,295 (5)	6,295 (5)
	LITERS	20,102	21,578 (2)	23,168 (3)	21,964 (4)	23,827 (5)	23,827 (5)
	POUNDS	35,584	38,197 (2)	41,011 (3)	38,880 (4)	42,177 (5)	42,177 (5)
	KILOGRAMS	16,141	17,326 (2)	18,602 (3)	17,636 (4)	19,131 (5)	19,131 (5)

NOTES:

1. OPERATING EMPTY WEIGHT FOR BASELINE MIXED CLASS CONFIGURATION. CONSULT WITH AIRLINE FOR SPECIFIC WEIGHTS AND CONFIGURATIONS.
2. AIRPLANE WITH 390 GAL (1,475 L) AUXILIARY FUEL TANK IN AFT CARGO COMPARTMENT
3. AIRPLANE WITH 810 GAL (3,065 L) AUXILIARY FUEL TANK IN AFT CARGO COMPARTMENT
4. AIRPLANE WITH 500 GAL (1,893 L) AUXILIARY FUEL TANK IN AFT CARGO COMPARTMENT
5. AIRPLANE WITH 1,000 GAL (3,785 L) AUXILIARY FUEL TANK IN AFT CARGO COMPARTMENT

2.1.8 General Characteristics: Model 737-500

CHARACTERISTICS	UNITS	MODEL 737-500				
		CFM56-3B1 ENGINES (18,500 LB SLST)			CFM56-3B1 ENGINES (20,000 LB SLST)	
MAX DESIGN - TAXI WEIGHT	POUNDS	116,000	125,000	134,000	125,000	136,500
	KILOGRAMS	52,617	56,699	60,781	56,699	61,915
MAX DESIGN - TAKEOFF WEIGHT	POUNDS	115,500	124,500	133,500	133,500	136,000
	KILOGRAMS	52,390	56,472	60,555	60,555	61,689
MAX DESIGN - LANDING WEIGHT	POUNDS	110,000	110,000	110,000	110,000	110,000
	KILOGRAMS	49,8965	49,895	49,895	49,895	49,895
MAX DESIGN - ZERO FUEL WEIGHT	POUNDS	102,500	102,500	102,500	102,500	103,000
	KILOGRAMS	46,493	46,493	46,493	46,493	46,720
OPERATING - EMPTY WEIGHT (1)	POUNDS	69,030	69,030	69,030	69,030	69,030
	KILOGRAMS	31,311	31,311	31,311	31,311	31,311
MAX STRUCTURAL - PAYLOAD	POUNDS	33,470	33,470	33,470	33,470	33,470
	KILOGRAMS	15,182	15,182	15,182	15,182	15,182
SEATING CAPACITY	TWO-CLASS	108: 8 FIRST CLASS AND 100 ECONOMY				
	ALL-ECONOMY	122 AT SIX ABREAST; FAA EXIT LIMIT: 149				
MAX CARGO VOLUME - LOWER DECK	CUBIC FEET	822	683 (2)	595 (3)	671 (4)	546 (5)
	CUBIC METERS	23.3	19.3 (2)	16.8 (3)	19.0 (4)	15.5 (5)
USABLE FUEL	U.S. GALLONS	5,311	5,701 (2)	6,121 (3)	5,803 (4)	6,295 (5)
	LITERS	20,102	21,578 (2)	23,168 (3)	21,964 (4)	23,827 (5)
	POUNDS	35,584	38,197 (2)	41,011 (3)	38,880 (4)	42,177 (5)
	KILOGRAMS	16,141	17,326 (2)	18,602 (3)	17,636 (4)	19,131 (5)

NOTES:

1. OPERATING EMPTY WEIGHT FOR BASELINE MIXED CLASS CONFIGURATION. CONSULT WITH AIRLINE FOR SPECIFIC WEIGHTS AND CONFIGURATIONS.
2. AIRPLANE WITH 390 GAL (1,475 L) AUXILIARY FUEL TANK IN AFT CARGO COMPARTMENT
3. AIRPLANE WITH 810 GAL (3,065 L) AUXILIARY FUEL TANK IN AFT CARGO COMPARTMENT
4. AIRPLANE WITH 500 GAL (1,893 L) AUXILIARY FUEL TANK IN AFT CARGO COMPARTMENT
5. AIRPLANE WITH 1,000 GAL (3,785 L) AUXILIARY FUEL TANK IN AFT CARGO COMPARTMENT

2.2 GENERAL DIMENSIONS

2.2.1 General Dimensions: Model 737-100

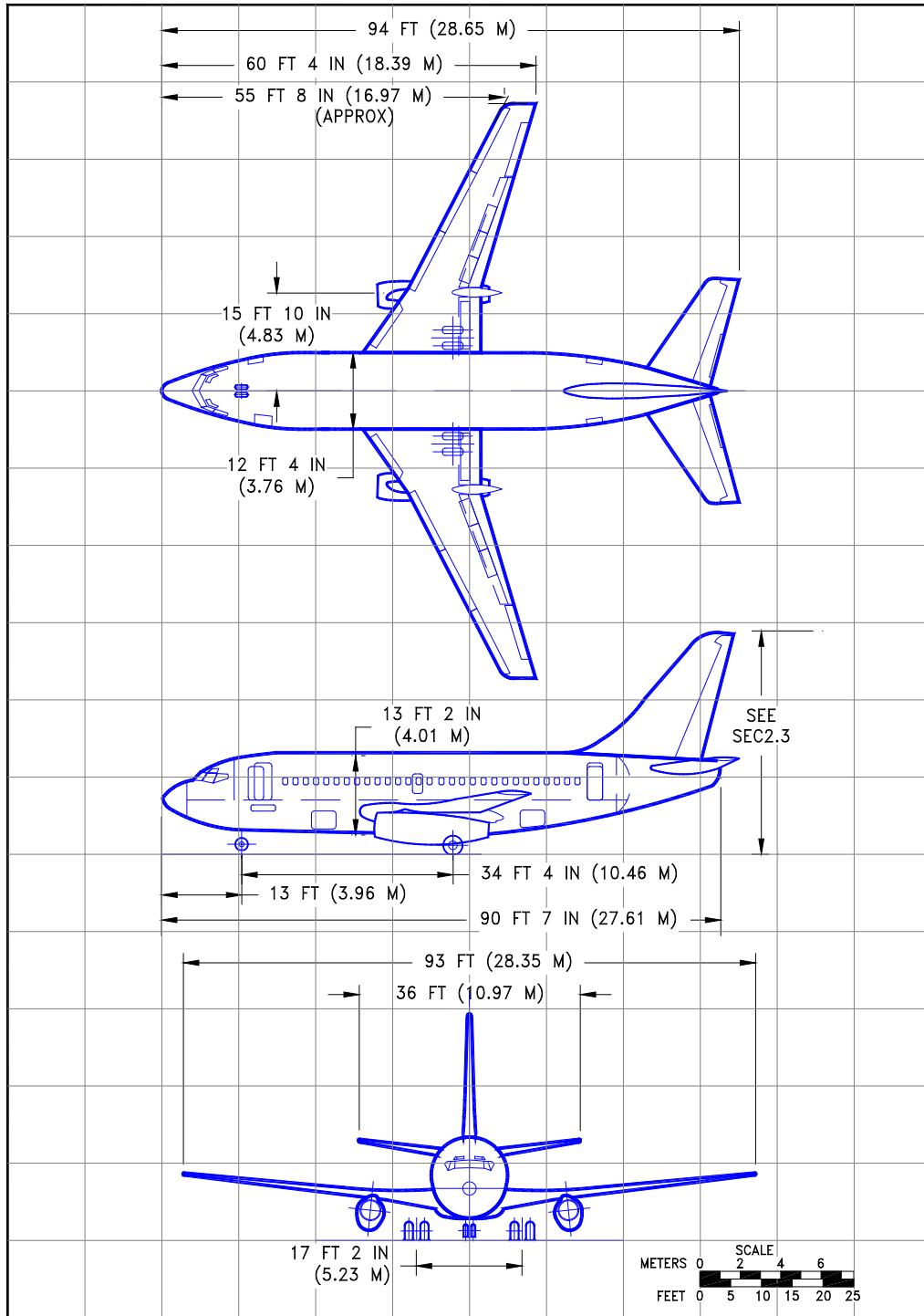

D6-58325-6

REV D

March 2023

2-10

2.2.2 General Dimensions: Model 737-200

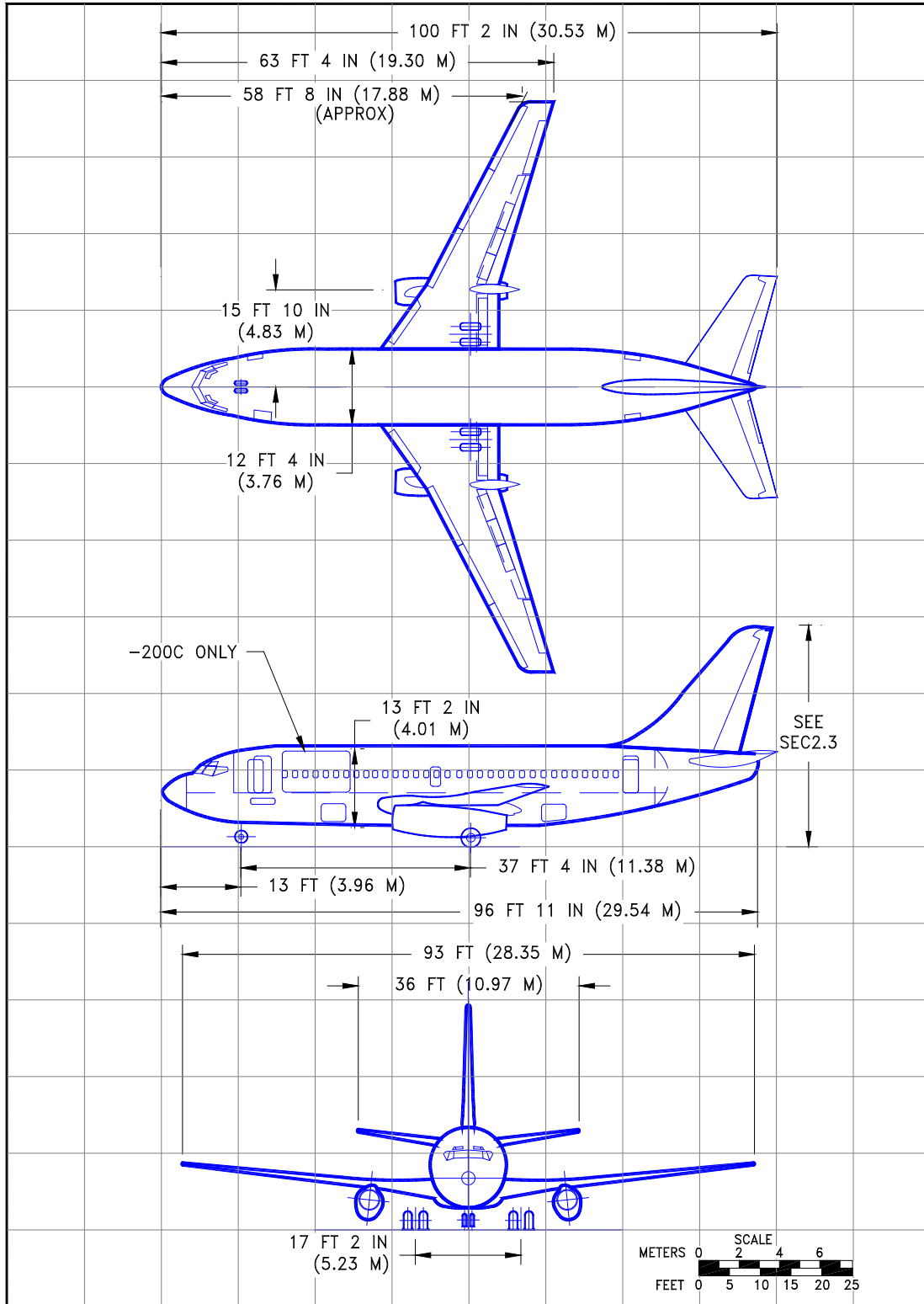

D6-58325-6

REV D

March 2023

2-11

2.2.3 General Dimensions: Model 737-300

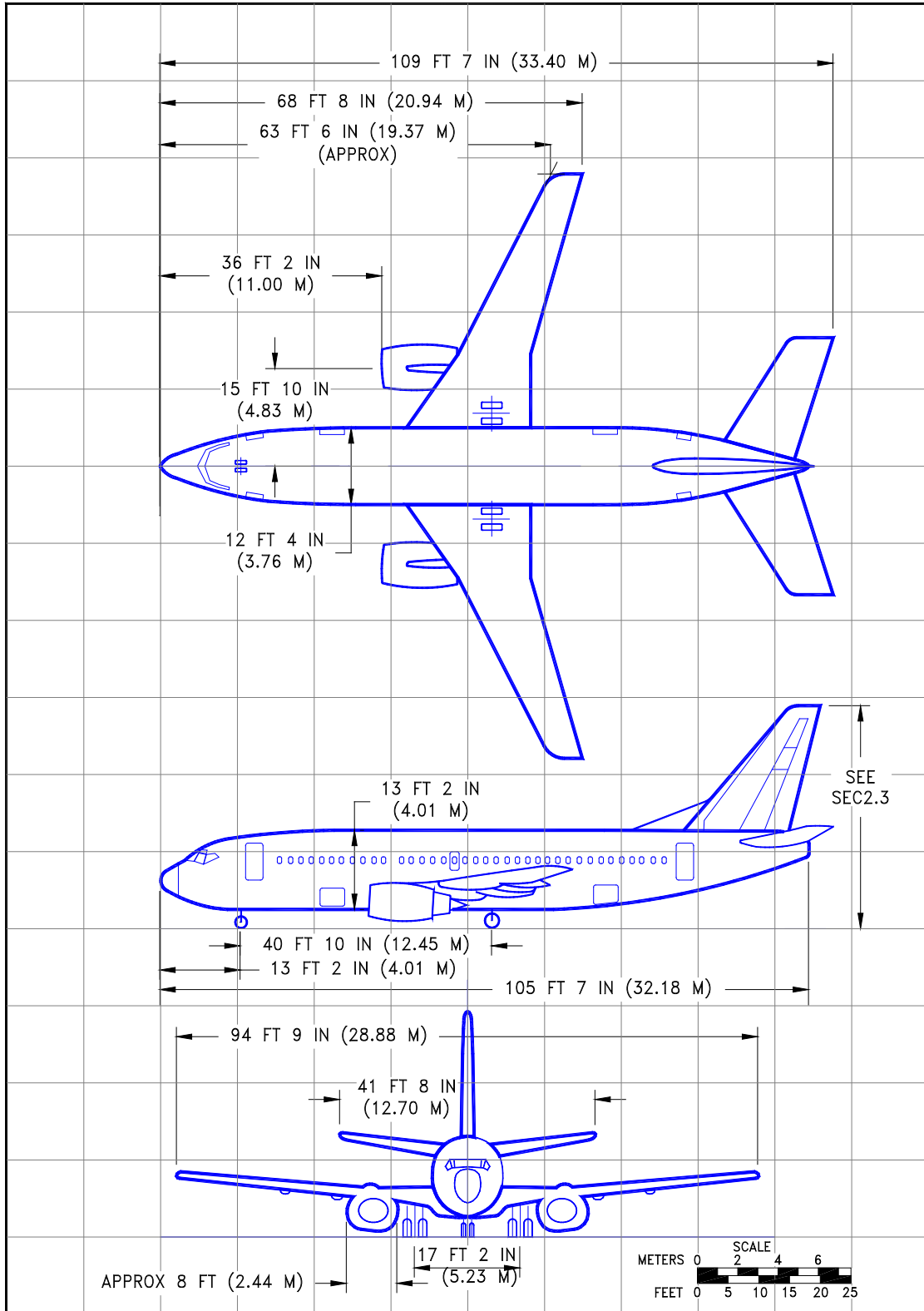

D6-58325-6

REV D

March 2023

2-12

2.2.4 General Dimensions: Model 737-300W

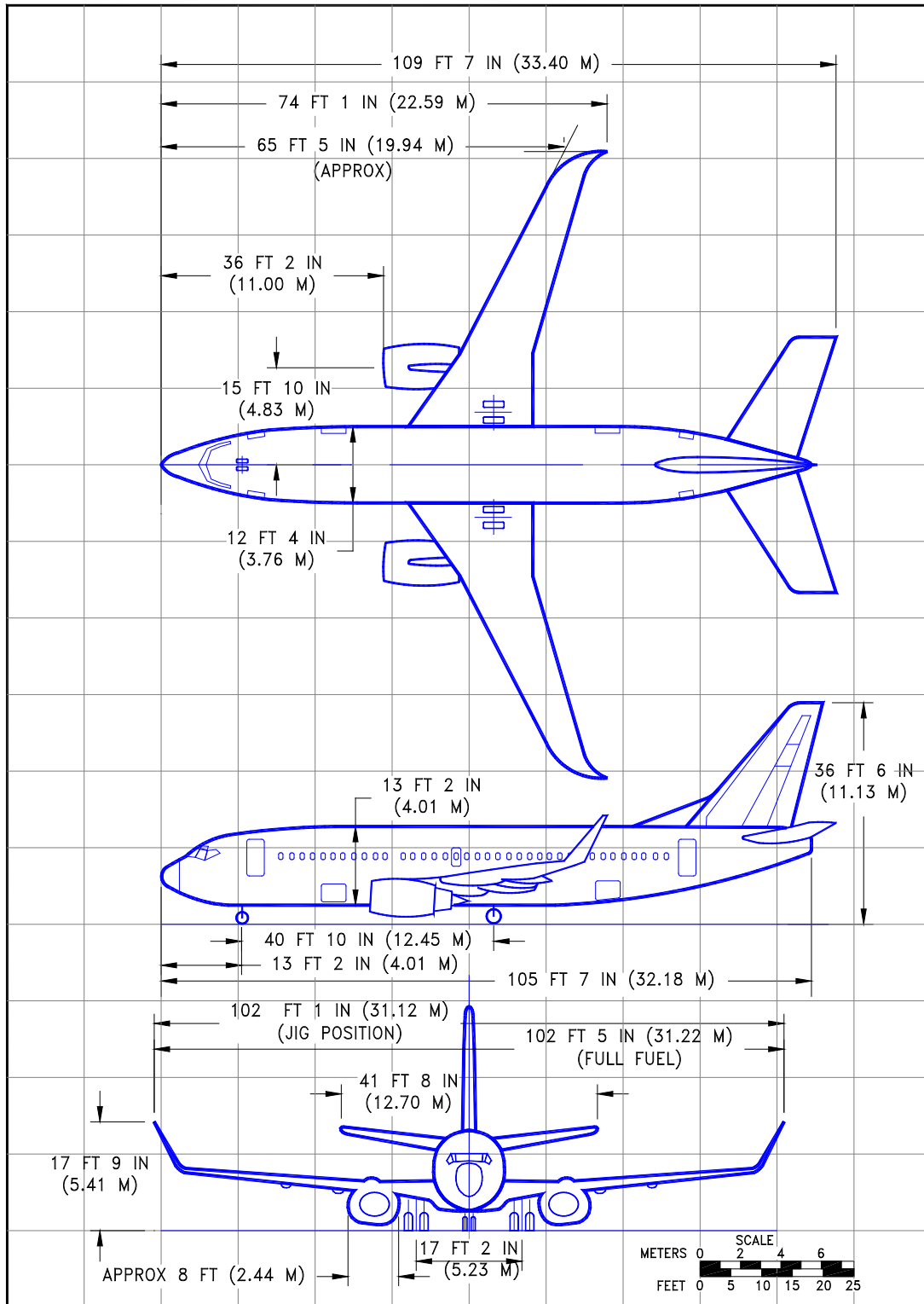

D6-58325-6

REV D

March 2023

2-13

2.2.5 General Dimensions: Model 737-400

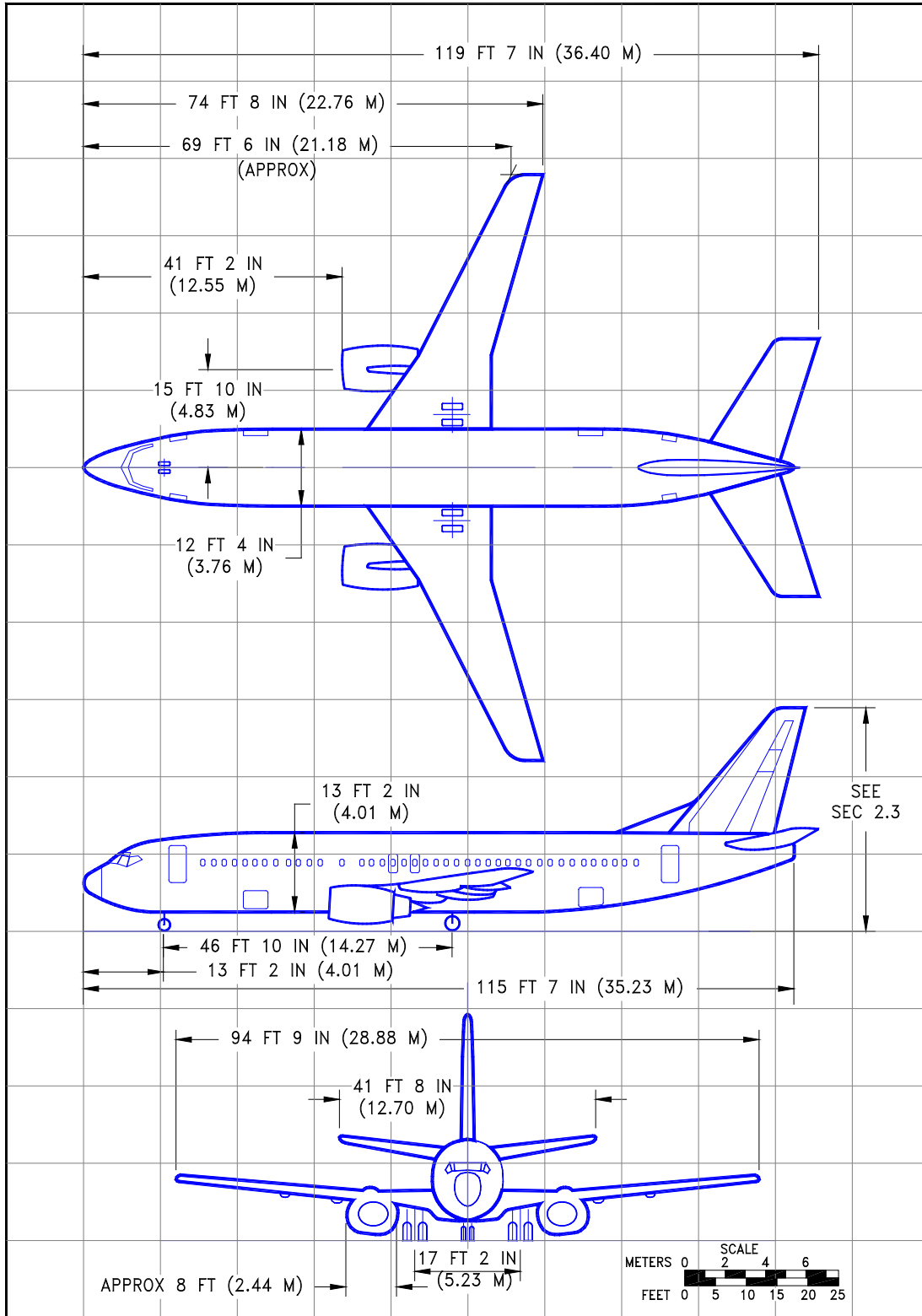

D6-58325-6

REV D

March 2023

2-14

2.2.6 General Dimensions: Model 737-500

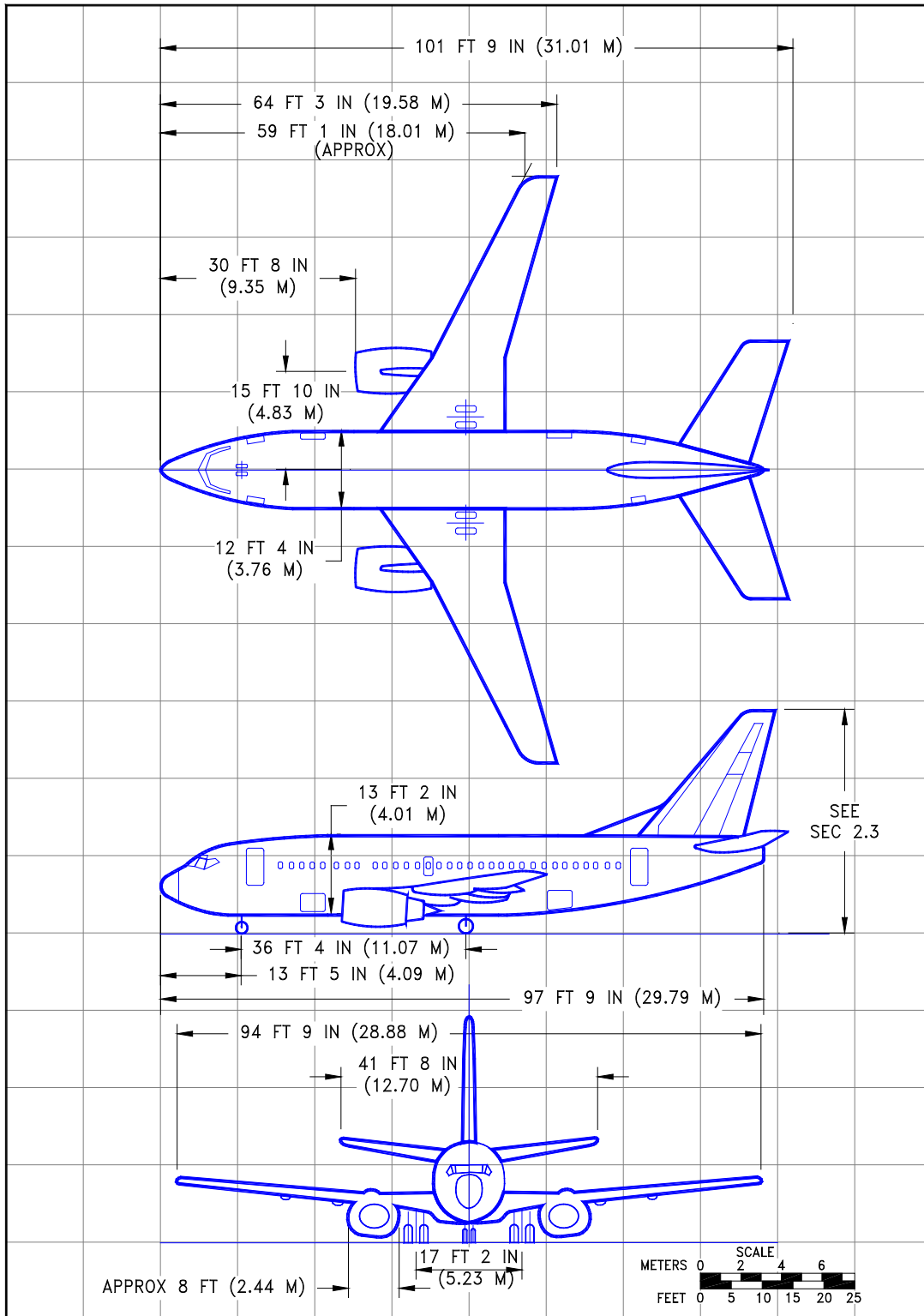

D6-58325-6

REV D

March 2023

2-15

2.3 GROUND CLEARANCES

2.3.1 Ground Clearances: Model 737-100, -200, -200C

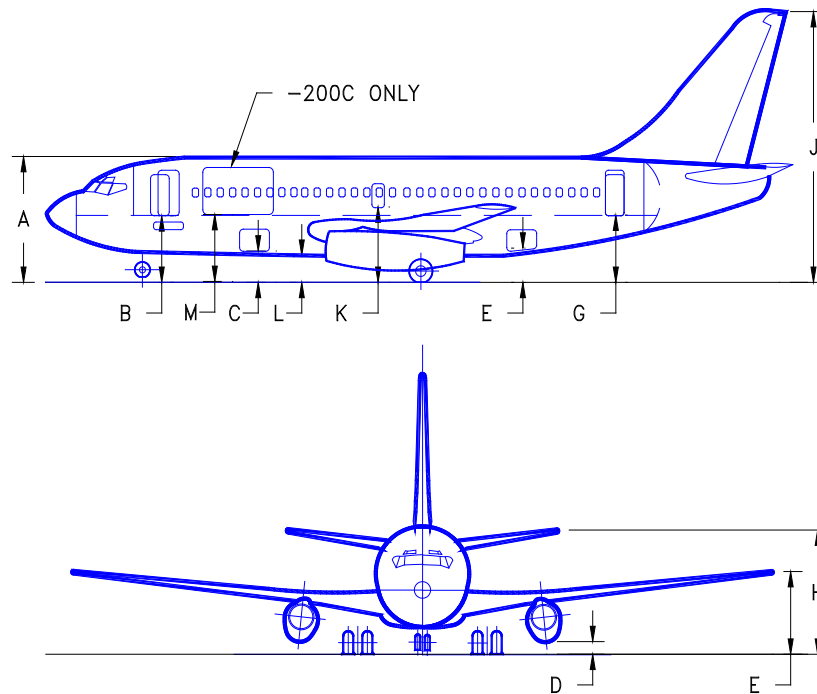

DESCRIPTION	737-100				737-200, -200C				
	MAX (AT OEW)		MIN (AT MTW)		MAX (AT OEW)		MIN (AT MTW)		
	FT - IN	M	FT - IN	M	FT - IN	M	FT - IN	M	
A	TOP OF FUSELAGE	16 - 9	5.11	16 - 5	5.00	16 - 9	5.11	16 - 4	4.98
B	ENTRY DOOR NO 1	8 - 8	2.64	8 - 1	2.46	8 - 7	2.62	8 - 1	2.46
C	FWD CARGO DOOR	4 - 3	1.30	3 - 10	1.17	4 - 3	1.30	3 - 10	1.17
D	ENGINE	1 - 11	0.58	1 - 8	0.51	1 - 11	0.58	1 - 8	0.51
E	WINGTIP	10 - 2	3.09	10 - 0	3.05	10 - 2	3.09	10 - 0	3.05
F	AFT CARGO DOOR	5 - 1	1.55	5 - 0	1.52	4 - 9	1.45	4 - 9	1.45
G	ENTRY DOOR NO 2	9 - 0	2.74	9 - 1	2.77	9 - 0	2.74	9 - 2	2.79
H	STABILIZER	16 - 8	5.08	17 - 0	5.18	16 - 8	5.08	17 - 1	5.21
J	VERTICAL TAIL	36 - 10	11.23	37 - 2	11.33	36 - 10	11.23	37 - 3	11.35
K	OVERWING EXIT DOOR	10 - 5	3.18	10 - 3	3.12	10 - 5	3.18	10 - 3	3.12
L	BOTTOM OF FUSELAGE	3 - 7	1.09	3 - 1	0.94	3 - 6	1.07	3 - 0	0.91
M	MAIN DECK CARGO DOOR	-	-	-	-	8 - 7	2.62	8 - 1	2.46

NOTES: CLEARANCES SHOWN ARE NOMINAL. ADD PLUS OR MINUS 3 INCHES TO ACCOUNT FOR VARIATIONS IN LOADING, OLEO AND TIRE PRESSURES, CENTER OF GRAVITY, ETC.

DURING ROUTINE SERVICING, THE AIRPLANE REMAINS RELATIVELY STABLE, PITCH AND ELEVATION CHANGES OCCURRING SLOWLY.

2.3.2 Ground Clearances: Model 737-300, -400, -500

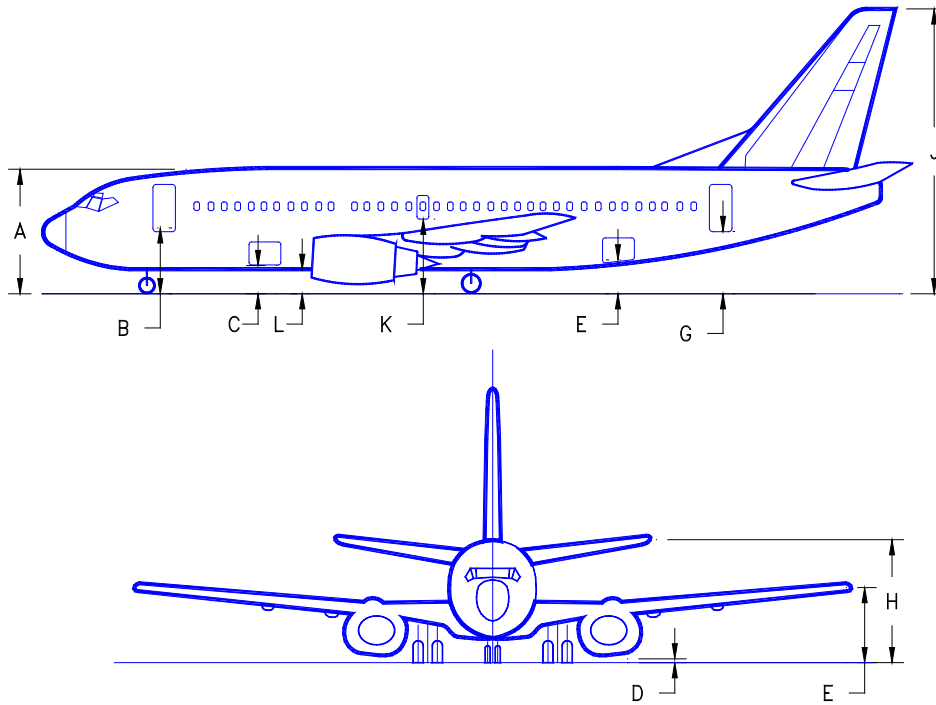

DESCRIPTION	737-300, -400, -500				
	MAX (AT OEW)		MIN (AT MTW)		
	FT - IN	M	FT - IN	M	
A	TOP OF FUSELAGE	17 - 3	5.26	16 - 10	5.13
B	ENTRY DOOR NO 1	9 - 1	2.77	8 - 7	2.62
C	FWD CARGO DOOR	4 - 7	1.40	4 - 2	1.27
D	ENGINE	1 - 9	0.53	1 - 6	0.46
E	WINGTIP	10 - 2	3.09	10 - 0	3.05
F	AFT CARGO DOOR	4 - 6	1.37	4 - 6	1.37
G	ENTRY DOOR NO 2	8 - 7	2.62	8 - 9	2.67
H	STABILIZER	16 - 3	4.95	16 - 8	5.08
J	VERTICAL TAIL	36 - 4	11.07	36 - 7	11.15
K	OVERWING EXIT DOOR	10 - 6	3.20	10 - 4	3.15
L	BOTTOM OF FUSELAGE	3 - 10	1.17	3 - 4	1.02

NOTES: CLEARANCES SHOWN ARE NOMINAL. ADD PLUS OR MINUS 3 INCHES TO ACCOUNT FOR VARIATIONS IN LOADING, OLEO AND TIRE PRESSURES, CENTER OF GRAVITY, ETC.

DURING ROUTINE SERVICING, THE AIRPLANE REMAINS RELATIVELY STABLE, PITCH AND ELEVATION CHANGES OCCURRING SLOWLY.

2.4 INTERIOR ARRANGEMENTS

2.4.1 Interior Arrangements: Model 737-100

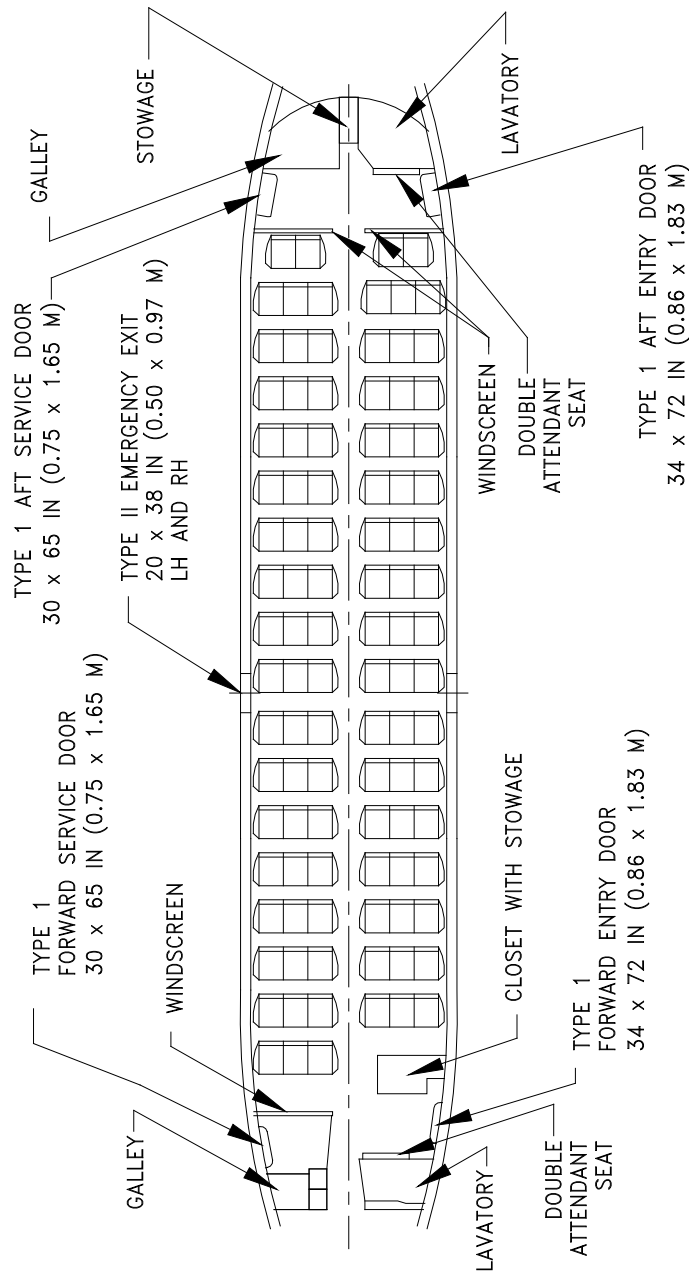

- NOTES:
- * SIX-ABREAST SEATING
 - * 103 PASSENGERS AT 34-IN (0.86 M) PITCH AS SHOWN
 - OR 118 PASSENGERS AT 30-IN (0.76 M) PITCH
 - * GALLEY AFT

2.4.2 Interior Arrangements: Model 737-200

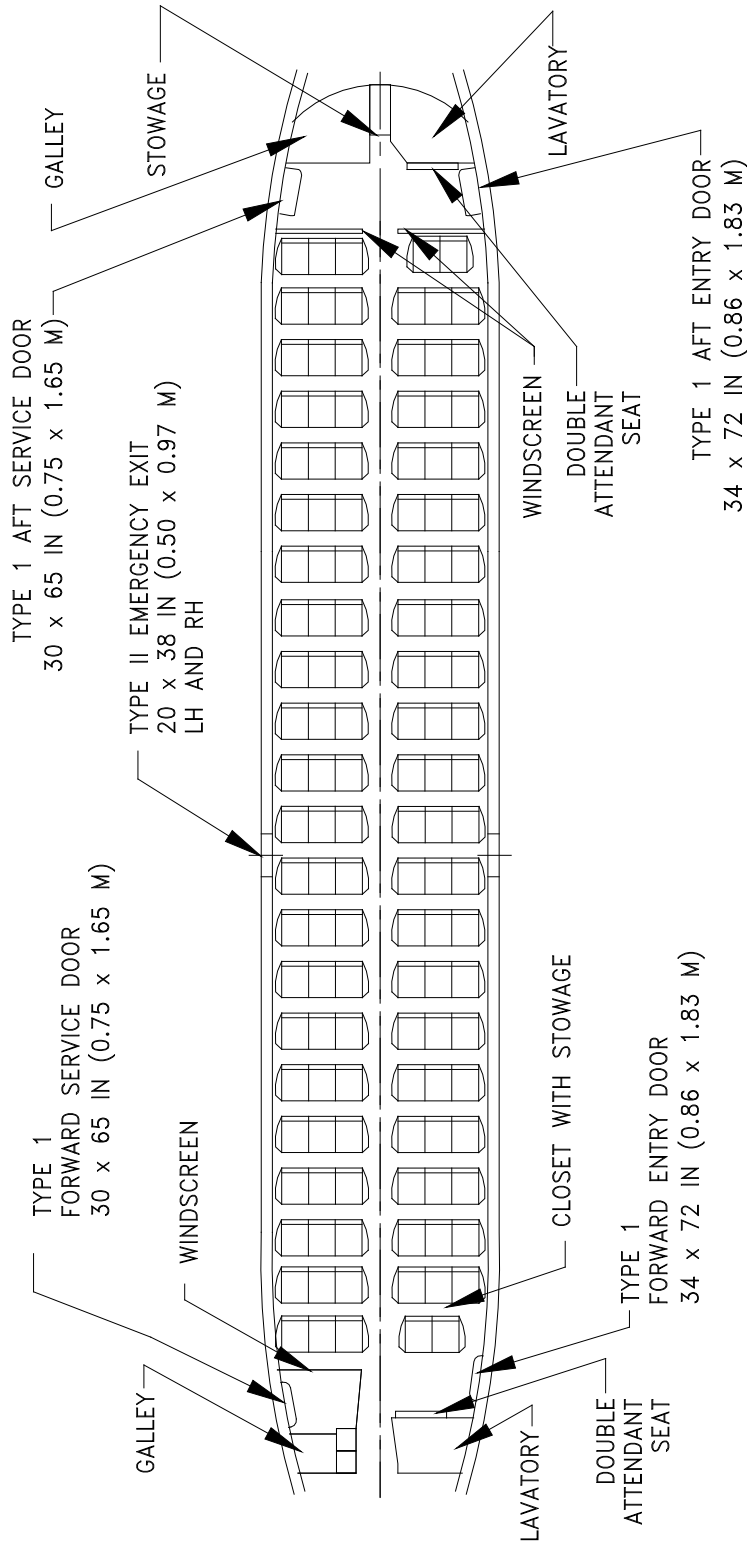

NOTES:

- * SIX-ABREAST SEATING
- * 115 PASSENGERS AT 34-IN (0.86 M) PITCH OR 120 PASSENGERS AT 32-IN (0.81 M) PITCH OR 130 PASSENGERS AT 30-IN (0.76 M) PITCH AS SHOWN
- * GALLEY FORWARD AND AFT

D6-58325-6

2.4.3 Interior Arrangements: Model 737-200, Mixed Class

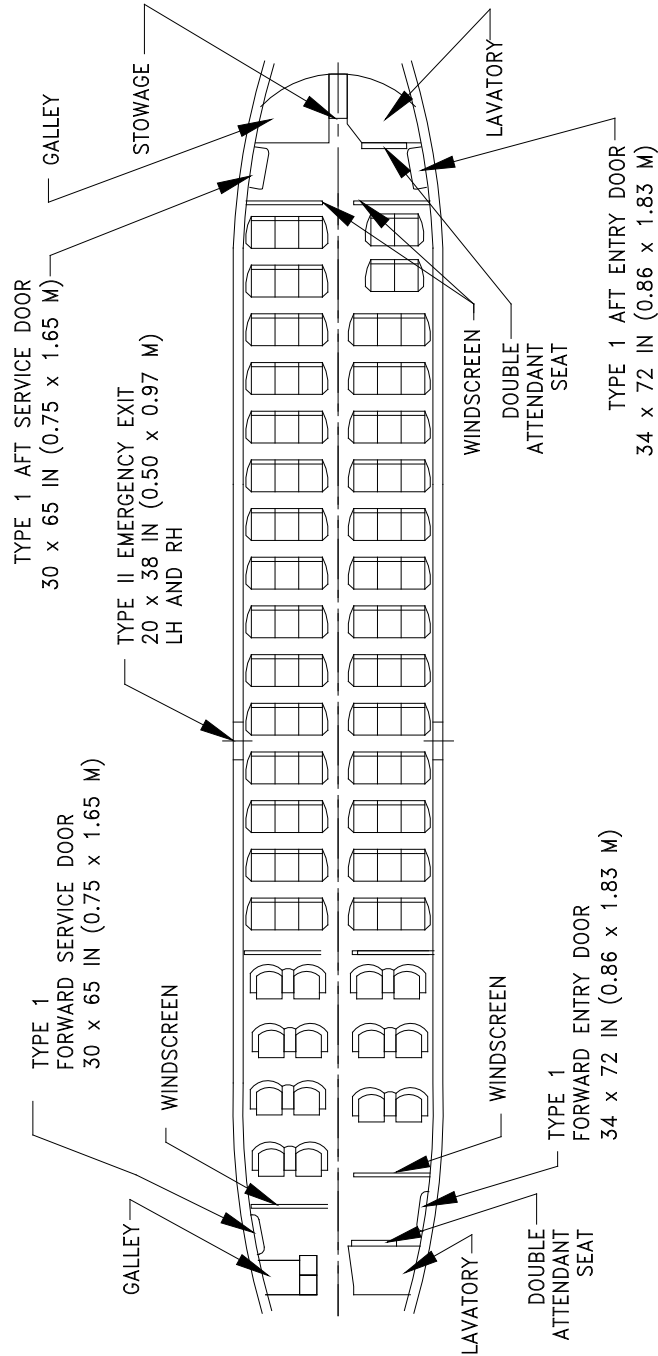

- NOTES:
- * 14 FIRST CLASS PASSENGERS, 4-ABREAST SEATING AT 38-IN (0.97-M) PITCH
 - * 88 ECONOMY CLASS PASSENGERS, 6-ABREAST AT 34-IN (0.86 M) PITCH OR

2.4.4 Interior Arrangements: Model 737-200 Executive Interior Class

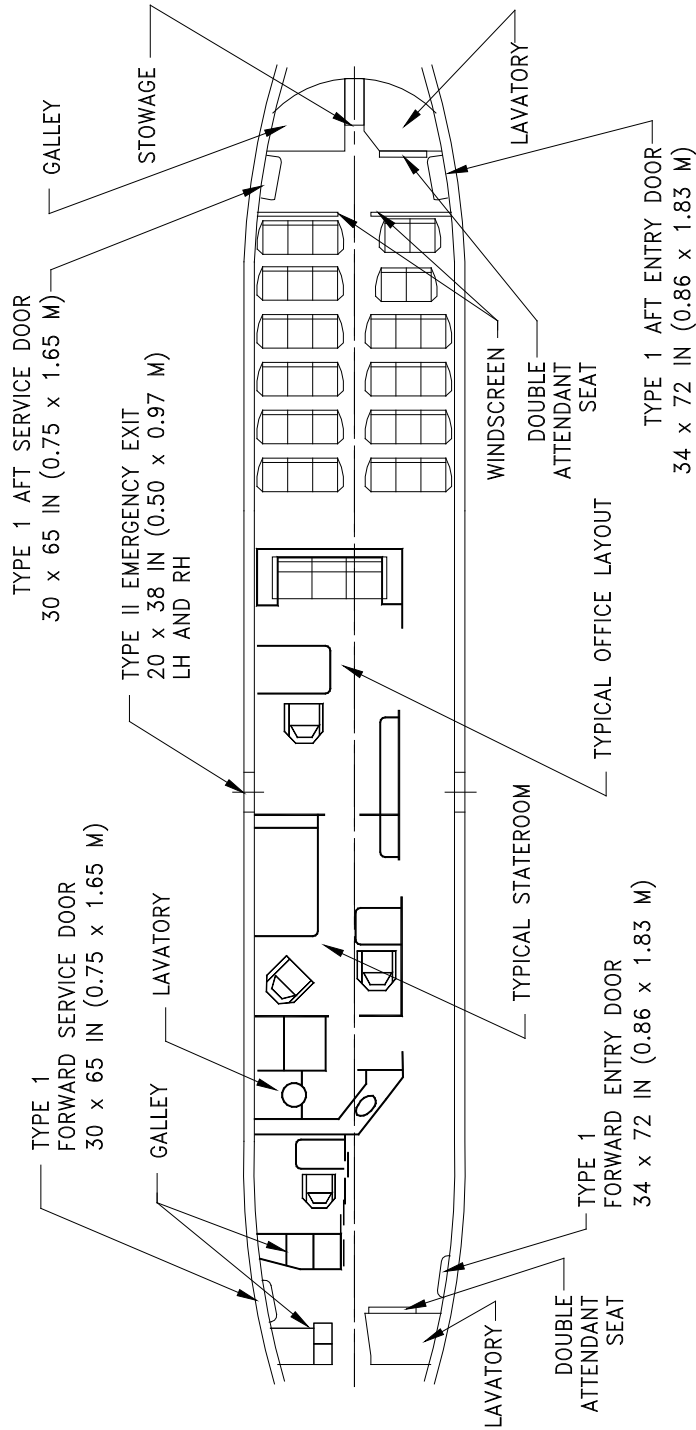

D6-58325-6

2.4.5 Interior Arrangements: Model 737-200 Passenger/Cargo Configuration

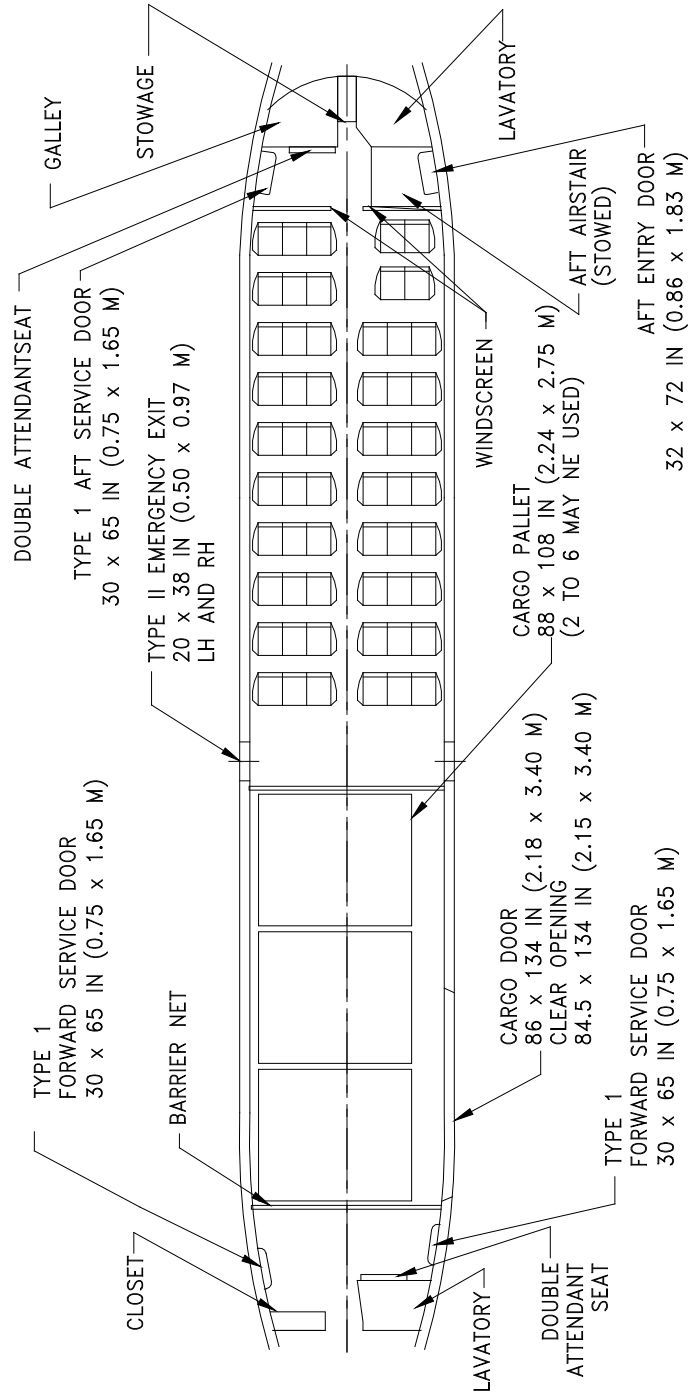

- NOTES:
- * 56 PASSENGERS AS SHOWN
 - * SIX-ABREAST SEATING AT 34-IN (0.86-M) PITCH
 - * THREE CARGO PALLETS

2.4.6 Interior Arrangements: Model 737-200C, All Cargo Configuration

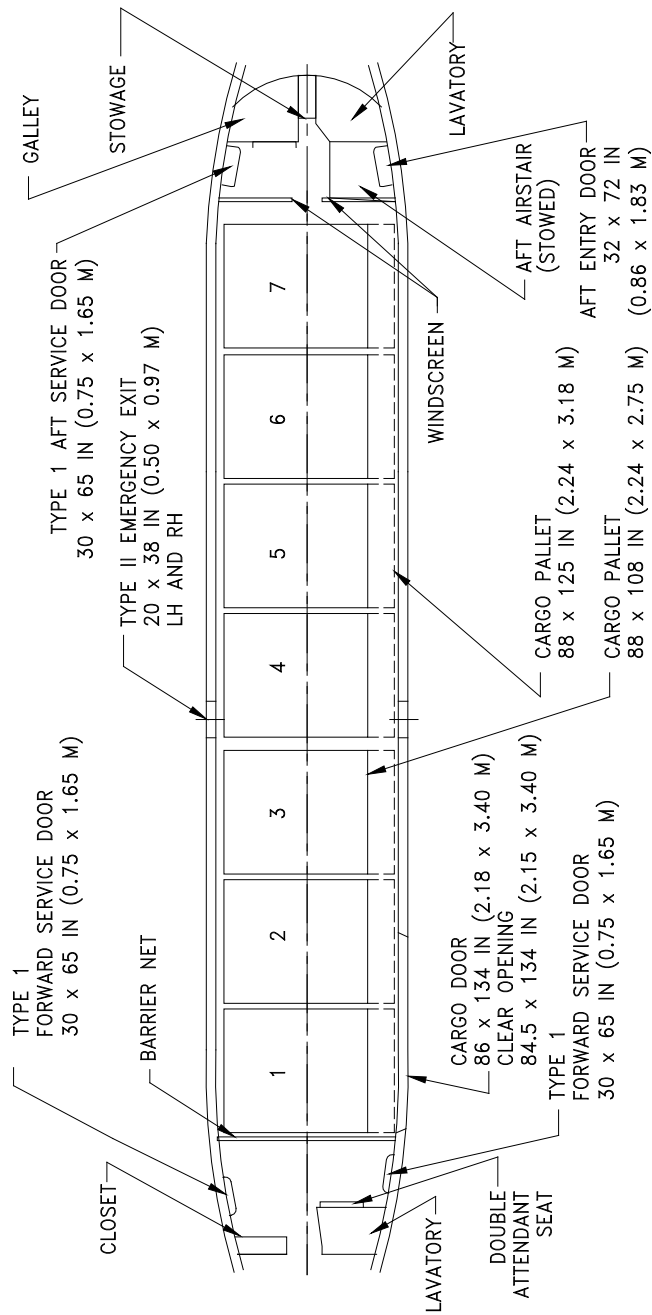

PALLET SIZE	TYPICAL MAIN DECK CARGO VOLUMES		
	VOLUME — EACH PALLET "C" SYSTEM	VOLUME — "QC" SYSTEM	VOLUME — 7 PALLETS "QC" SYSTEM
88 x 108 IN (2.24 x 2.75 M)	352.5 CU FT (10.0 CU M)	356.4 CU FT (10.1 CU M)	2,468 CU FT (70.0 CU M)
88 x 125 IN (2.24 x 3.18 M)	390 CU FT (11.1 CU M)	394.0 CU FT (11.2 CU M)	2,762 CU FT (78.3 CU M)

2.4.7 Interior Arrangements: Model 737-300

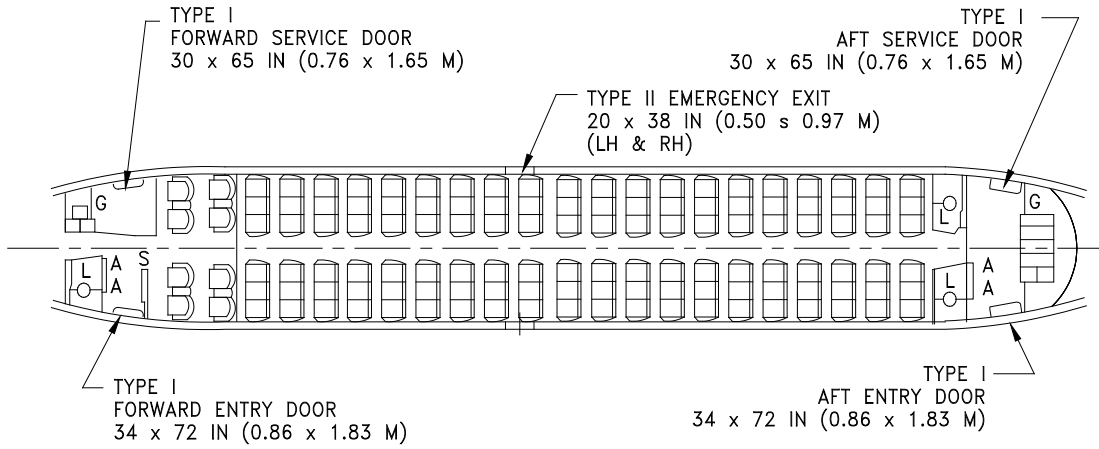

MIXED CLASS
8 FIRST CLASS SEATS AT 36-IN PITCH
120 ECONOMY CLASS SEATS AT 32-IN PITCH

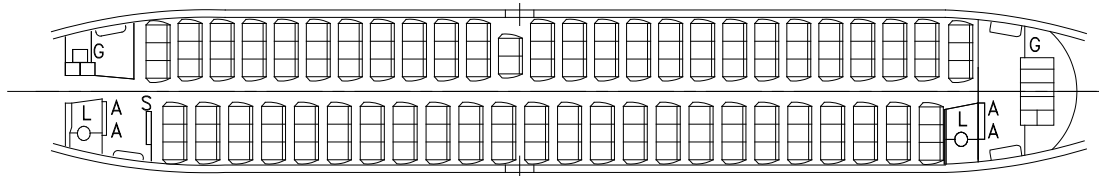

SINGLE CLASS
149 ECONOMY CLASS SEATS AT 30-IN PITCH

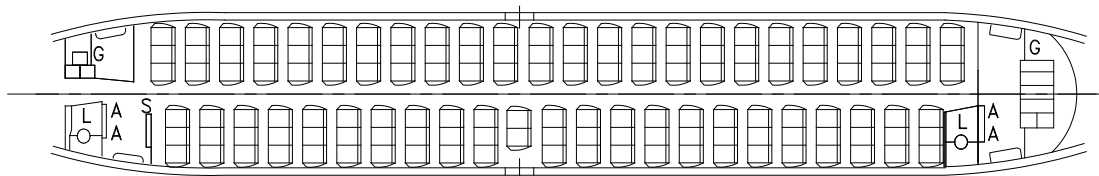

SINGLE CLASS
140 ECONOMY CLASS SEATS AT 32-IN PITCH

[A] ATTENDANT [C] CLOSET [G] GALLEY [L] LAVATORY [S] STOWAGE

D6-58325-6

REV D

March 2023

2-24

2.4.8 Interior Arrangements: Model 737-400

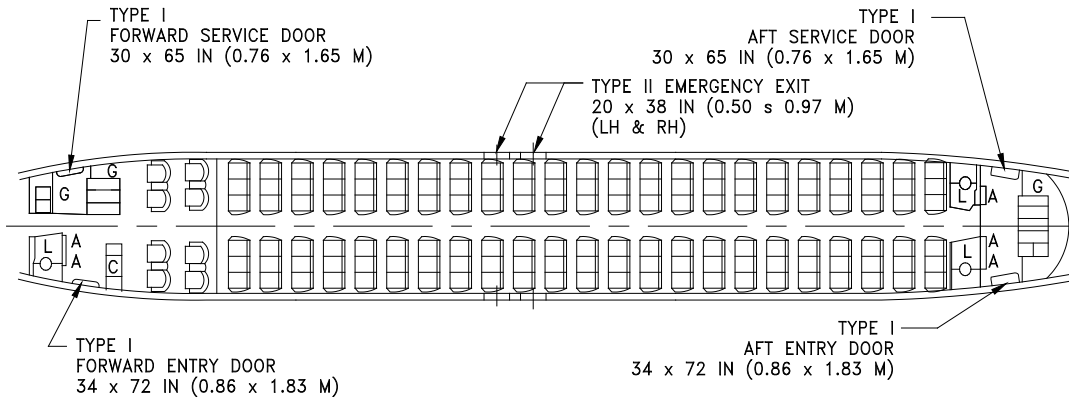

MIXED CLASS
8 FIRST CLASS SEATS AT 36-IN (0.91 M) PITCH
138 ECONOMY CLASS SEATS AT 32-IN (0.81 M) PITCH

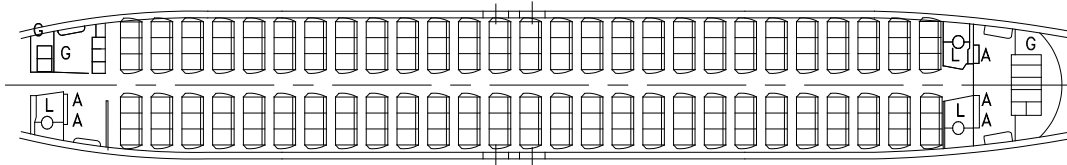

SINGLE CLASS
168 ECONOMY CLASS SEATS AT 30-IN (0.76 M) PITCH

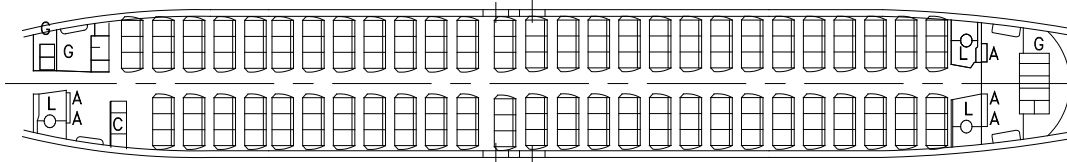

SINGLE CLASS
159 ECONOMY CLASS SEATS AT 32-IN PITCH

[A] ATTENDANT [C] CLOSET [G] GALLEY [L] LAVATORY [S] STOWAGE

2.4.9 Interior Arrangements: Model 737-500

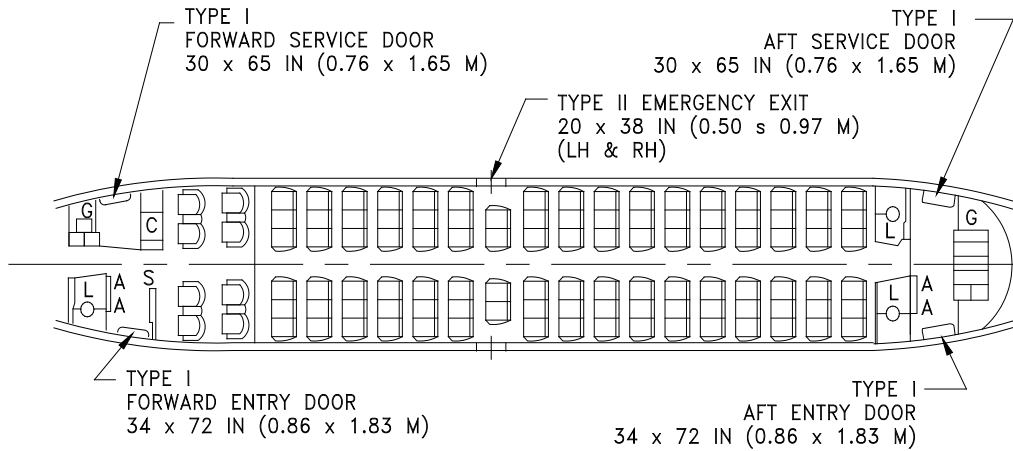

MIXED CLASS
8 FIRST CLASS SEATS AT 36-IN PITCH
100 ECONOMY CLASS SEATS AT 32-IN PITCH

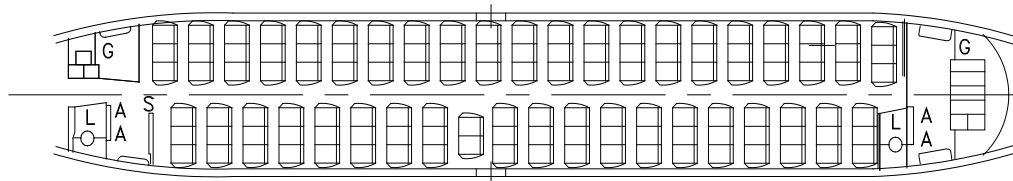

SINGLE CLASS
122 ECONOMY CLASS SEATS AT 32-IN PITCH

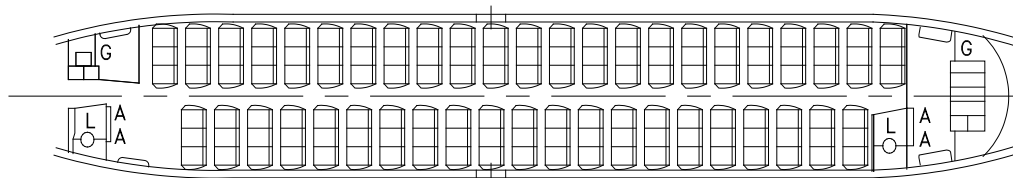

SINGLE CLASS
132 ECONOMY CLASS SEATS AT 30-IN PITCH

[A] ATTENDANT [C] CLOSET [G] GALLEY [L] LAVATORY [S] STORAGE

2.5.2 Cabin Cross-Sections: Model 737-200, Four-Abreast Seating With “Wide-Body Look” Interior

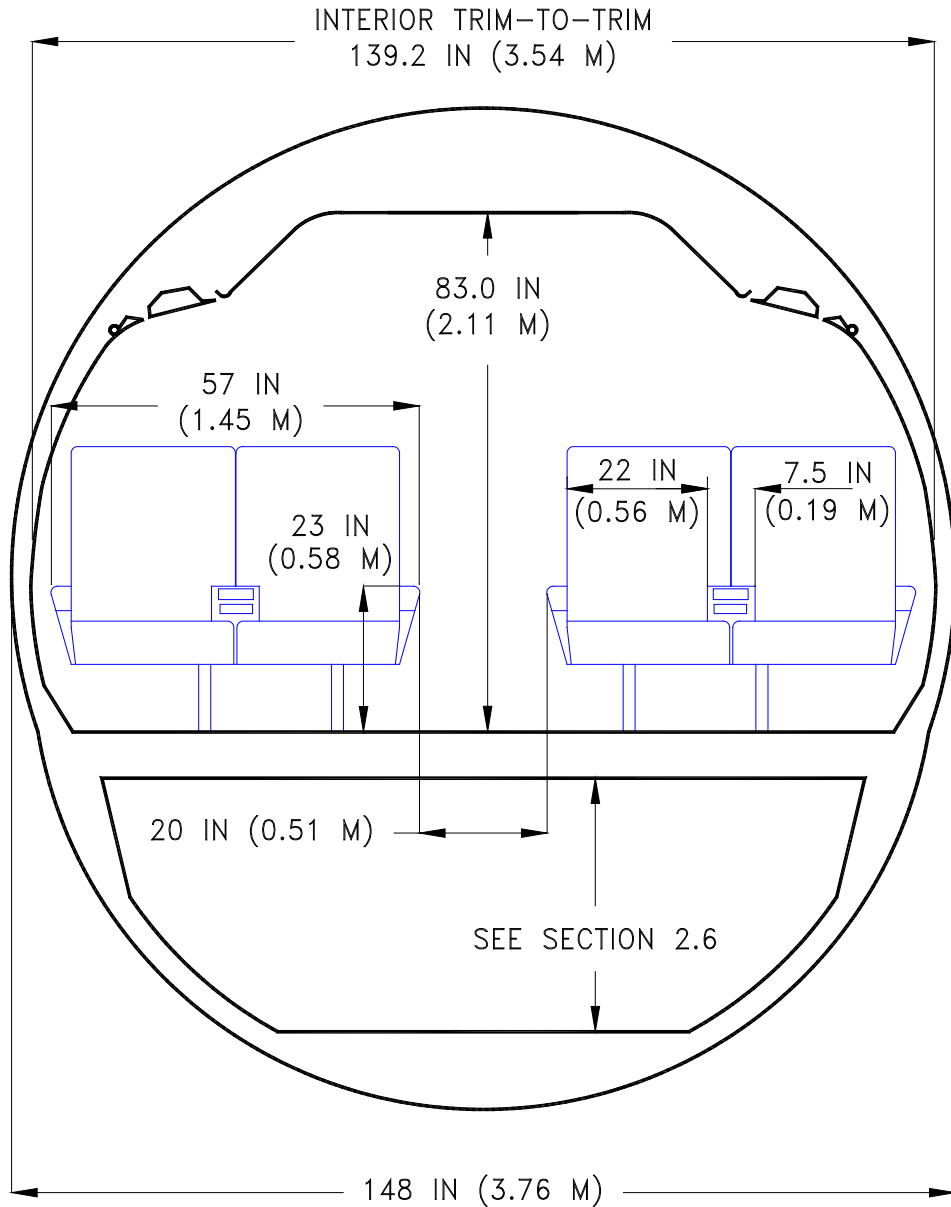

2.5.3 Cabin Cross-Sections: Model 737-200, Five-Abreast Seating With Carry All Compartments

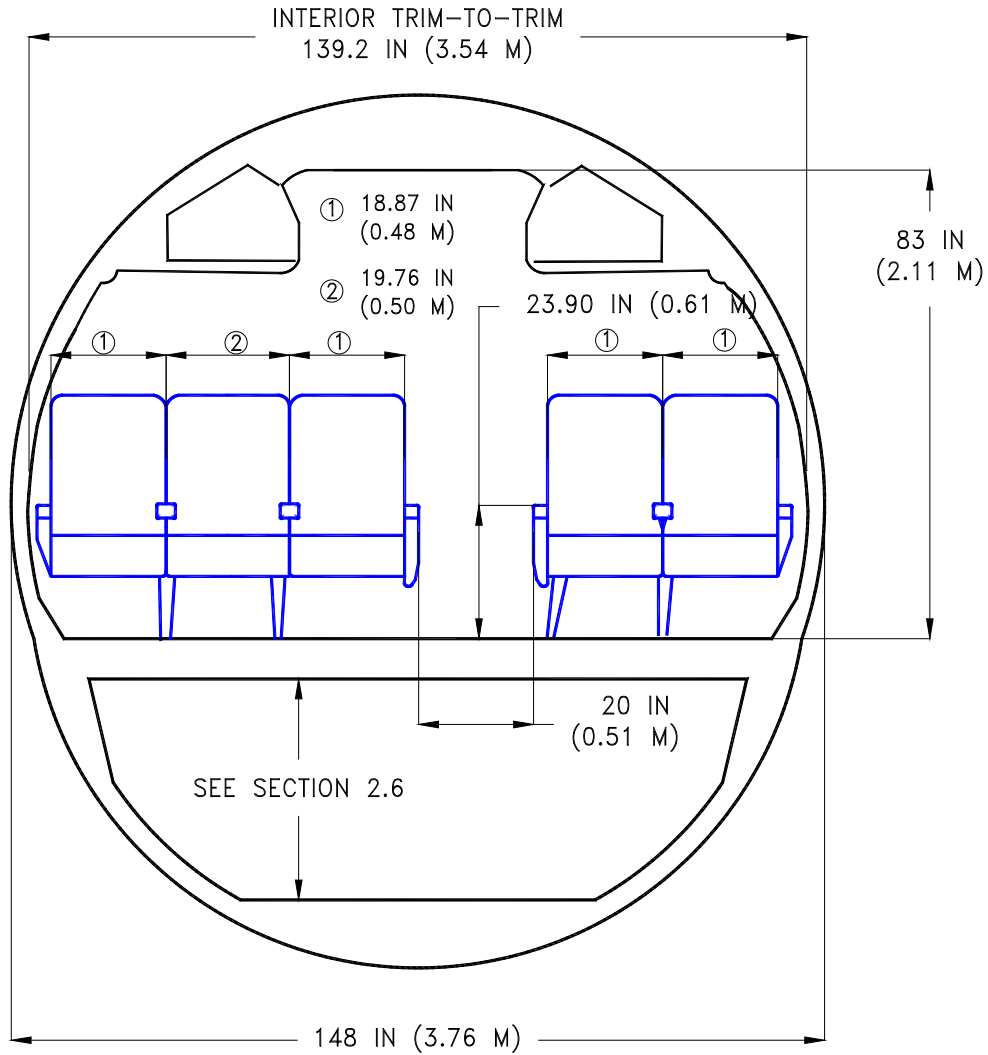

2.5.4 Cabin Cross-Sections: Model 737-200ADV, -300, -400, -500, Four-Abreast Seating

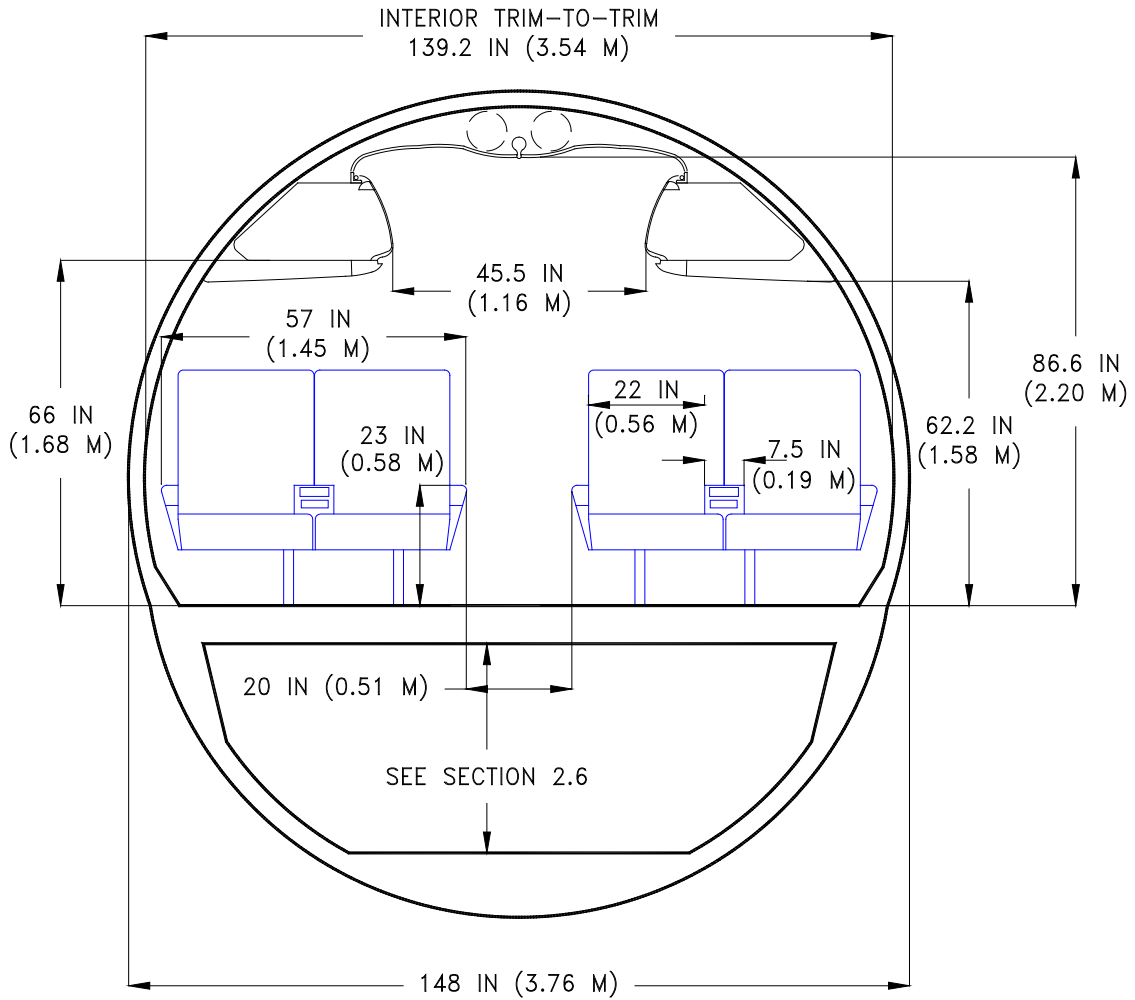

NOTE: CABIN INTERIOR FOR BBJ1 AND BBJ2 AIRPLANES ARE DEPENDENT ON CUSTOMER OPTION.

2.5.5 Cabin Cross-Sections: Model 737-200ADV, -300, -400, -500, Six-Abreast Seating

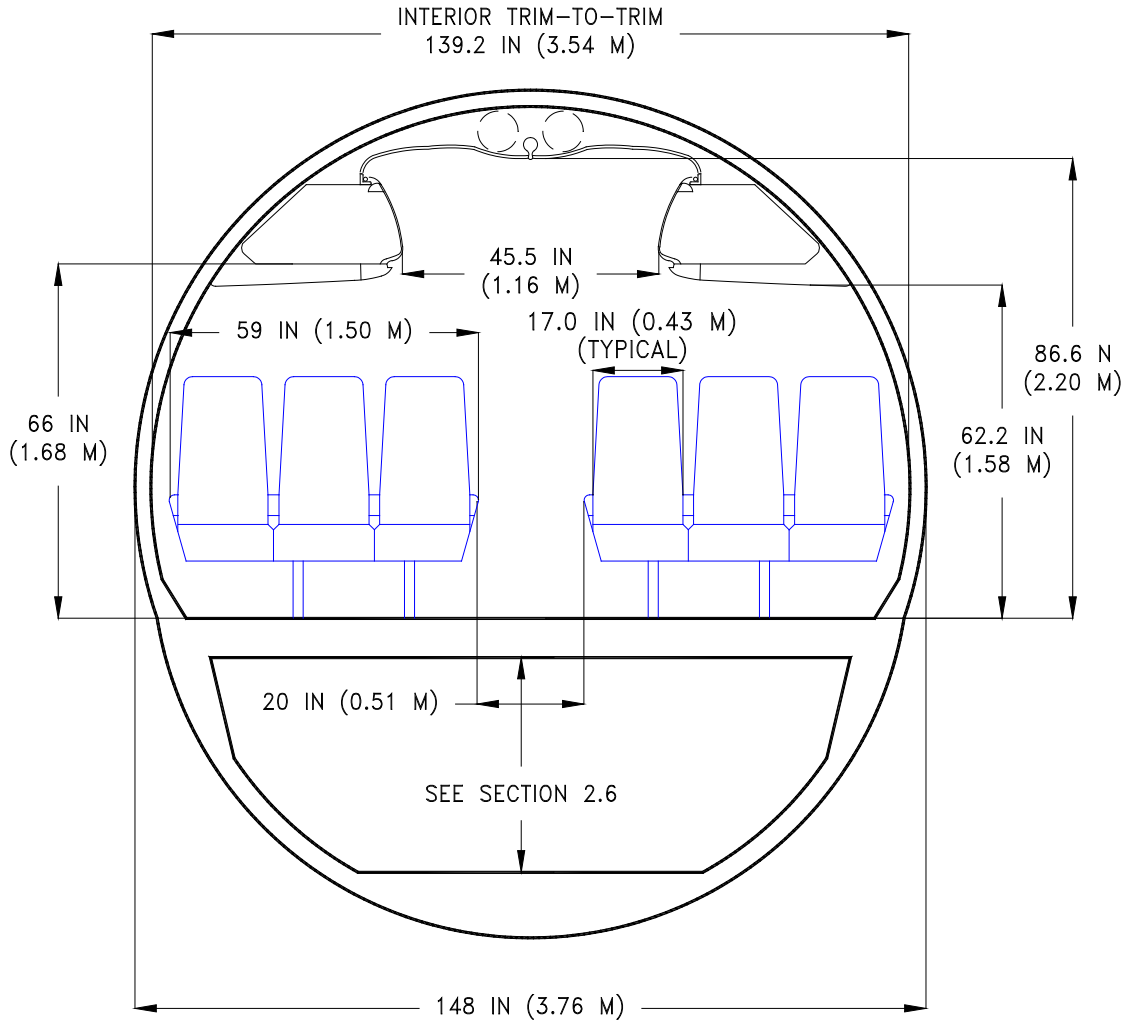

D6-58325-6

REV D

March 2023

2-31

2.6 LOWER CARGO COMPARTMENTS

2.6.1 Lower Cargo Compartments: Model 737-100, -200, -300, -400, -500, Dimensions

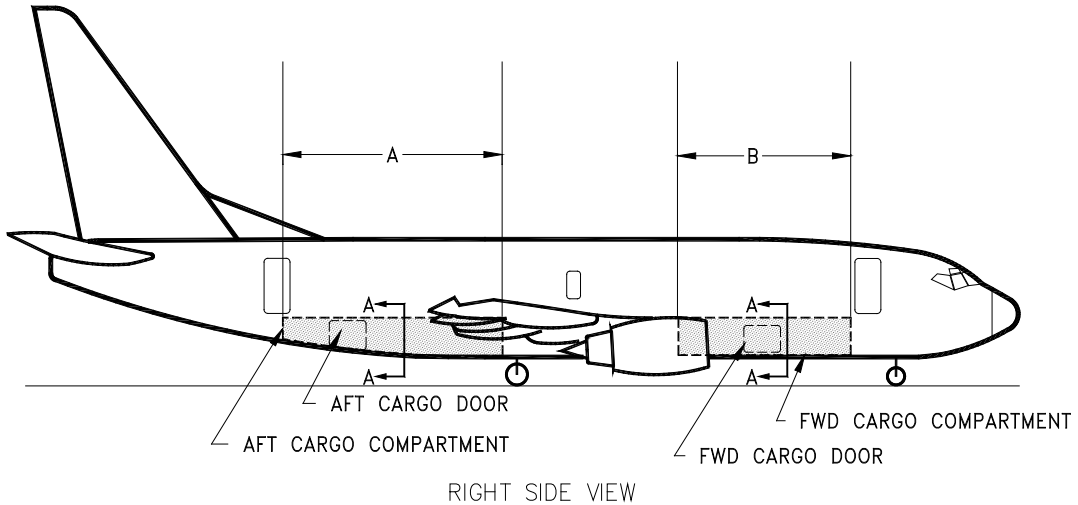

AIRPLANE MODEL	DIMENSION A	DIMENSION B
737-100	18 FT 3 IN (5.56 M)	11 FT 7 IN (3.53 M)
737-200	21 FT 5 IN (6.53 M)	14 FT 7 IN (4.45 M)
737-300	26 FT 5 IN (8.05 M)	16 FT 8 IN (5.08 M)
737-400	30 FT 5 IN (9.27 M)	22 FT 8 IN (6.91 M)
737-500	23 FT 1 IN (7.04 M)	12 FT 2 IN (3.71 M)

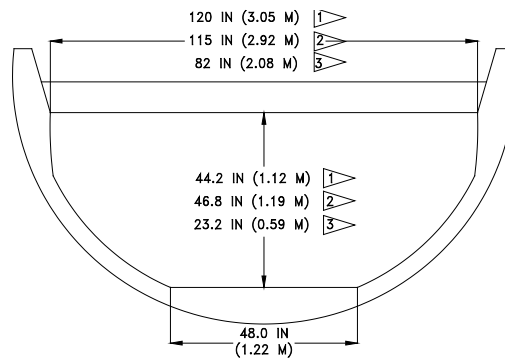

- SECTION A-A
- 1 FWD CARGO COMPARTMENT
 - 2 AFT CARGO COMPARTMENT, FWD BULKHEAD
 - 3 AFT CARGO COMPARTMENT, AFT BULKHEAD

2.6.2 Lower Cargo Compartments: Model 737-100, -200, Capacities

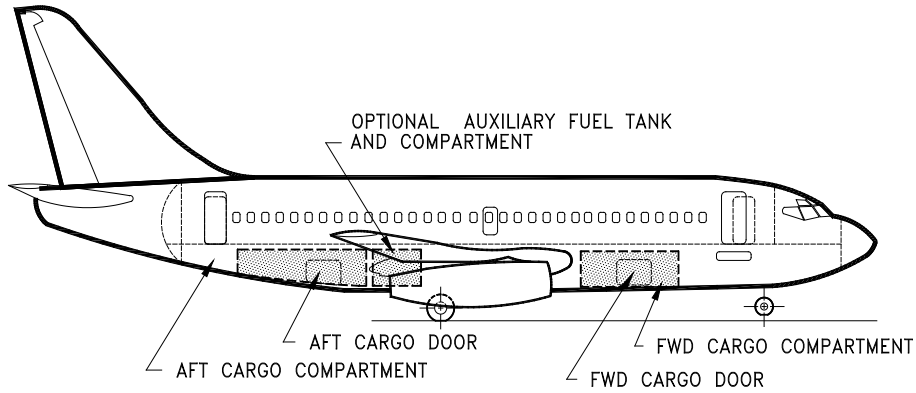

AIRPLANE MODEL	AFT CARGO COMPARTMENT			FORWARD COMPARTMENT BULK CARGO	TOTAL BULK CARGO
	BULK CARGO	AUXILIARY FUEL TANK CAPACITY	AUXILIARY FUEL TANK COMPARTMENT		
737-100	370 CU FT (10.48 CU M)	0	0	280 CU FT (7.93 CU M)	650 CU FT (18.41 CU M)
737-200 AND ADVANCED 737-200	505 CU FT (14.31 CU M)	0	0		875 CU FT (24.79 CU M)
	370 CU FT (10.48 CU M)	390 GAL (1,475 L)	135 CU FT (3.83 CU M)	370 CU FT (10.48 CU M)	740 CU FT (20.96 CU M)
	270 CU FT (7.65 CU M)	810 GAL (3,065 L)	235 CU FT (6.66 CU M)		640 CU FT (18.13 CU M)

2.6.3 Lower Cargo Compartments: Model 737-300, -400, -500, Capacities

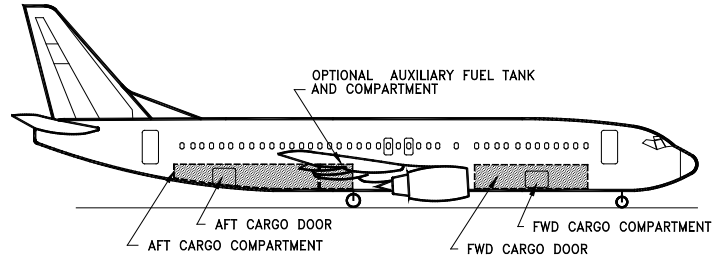

AIRPLANE MODEL	AFT CARGO COMPARTMENT			FORWARD COMPARTMENT BULK CARGO	TOTAL BULK CARGO	NOTES
	BULK CARGO	AUXILIARY FUEL TANK CAPACITY	AUXILIARY FUEL TANK COMPARTMENT CAPACITY			
737-300	643 CU FT (18.2 CU M)	0	0	425 CU FT (12.0 CU M)	1,068 CU FT (30.2 CU M)	(1)
	504 CU FT (14.3 CU M)	390 GAL (1,475 L)	139 CU FT (3.9 CU M)		929 CU FT (26.3 CU M)	(2)
	416 CU FT (11.8 CU M)	810 GAL (3,065 L)	227 CU FT (6.4 CU M)		841 CU FT (23.8 CU M)	(2)
	492 CU FT (13.9 CU M)	500 GAL (1,893 L)	151 CU FT (5.3 CU M)		917 CU FT (26.0 CU M)	(3)
	367 CU FT (10.4 CU M)	1,000 GAL (3,785 L)	276 CU FT (7.8 CU M)		792 CU FT (22.4 CU M)	(3)
737-400	766 CU FT (21.7 CU M)	0	0	607 CU FT (17.2 CU M)	1,373 CU FT (38.9 CU M)	(1)
	627 CU FT (17.7 CU M)	390 GAL (1,475 L)	139 CU FT (3.9 CU M)		1,234 CU FT (34.9 CU M)	(2)
	539 CU FT (15.3 CU M)	810 GAL (3,065 L)	227 CU FT (6.4 CU M)		1,146 CU FT (32.4 CU M)	(2)
	615 CU FT (17.4 CU M)	500 GAL (1,893 L)	151 CU FT (5.3 CU M)		1,222 CU FT (34.6 CU M)	(3)
	490 CU FT (13.9 CU M)	1,000 GAL (3,785 L)	276 CU FT (7.8 CU M)		1,097 CU FT (31.0 CU M)	(3)
737-500	535 CU FT (15.1 CU M)	0	0	287 CU FT (8.1 CU M)	822 CU FT (233.3 CU M)	(1)
	396 CU FT (11.2 CU M)	390 GAL (1,475 L)	139 CU FT (3.9 CU M)		683 CU FT (19.3 CU M)	(2)
	308 CU FT (8.7 CU M)	810 GAL (3,065 L)	227 CU FT (6.4 CU M)		595 CU FT (16.8 CU M)	(2)
	384 CU FT (10.9 CU M)	500 GAL (1,893 L)	151 CU FT (5.3 CU M)		671 CU FT (19.0 CU M)	(3)
	259 CU FT (7.3 CU M)	1,000 GAL (3,785 L)	276 CU FT (7.8 CU M)		546 CU FT (15.5 CU M)	(3)

NOTES

1. WITHOUT AUXILIARY FUEL TANK
2. WITH BOEING-INSTALLED AUXILIARY FUEL TANK
3. WITH ROGERSON-INSTALLED AUXILIARY FUEL TANK

2.7 DOOR CLEARANCES

2.7.1 Door Clearances: Model 737, All Models, Forward Main Entry Door No. 1

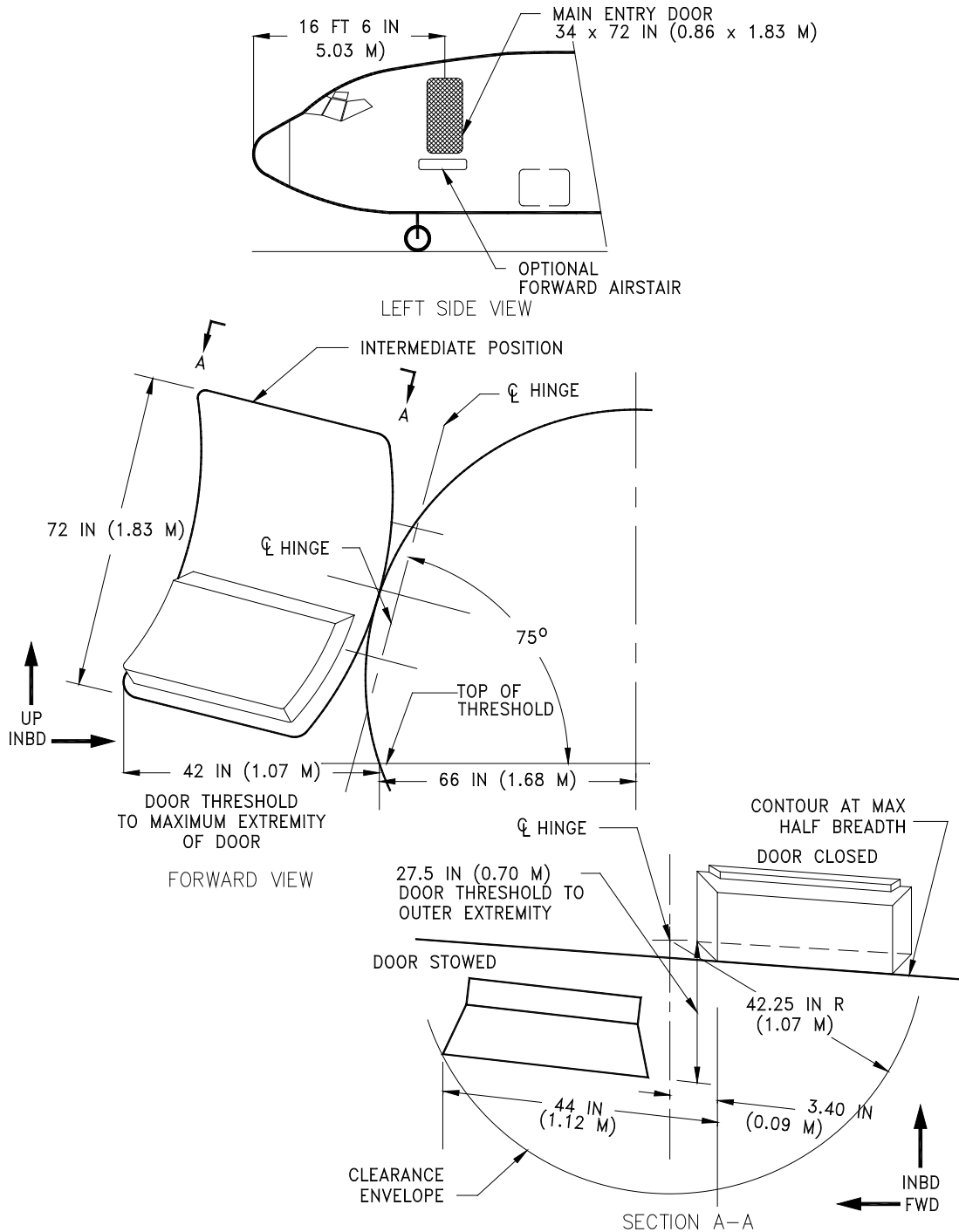

NOTES: 737-800BCF does not have Optional Forward Airstairs.

2.7.2 Door Clearances: Model 737, All Models, Optional Forward Airstairs, Main Entry Door No 1

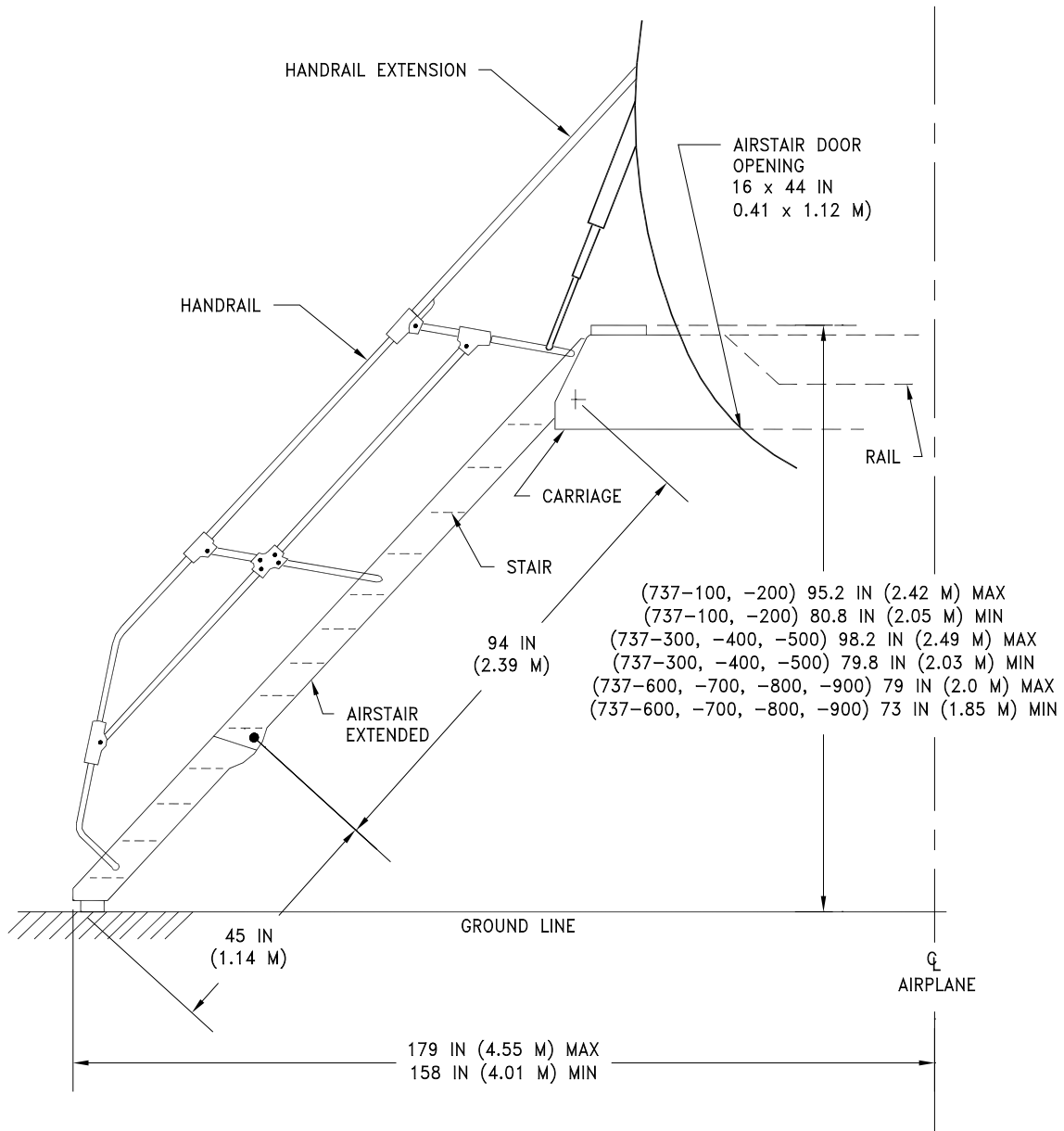

NOTES: 737-800BCF does not have Optional Forward Airstairs.

2.7.3 Door Clearances: Models 737-100, -200, -300, -400, -500, Locations of Sensors and Probes – Forward of Main Entry Door No 1

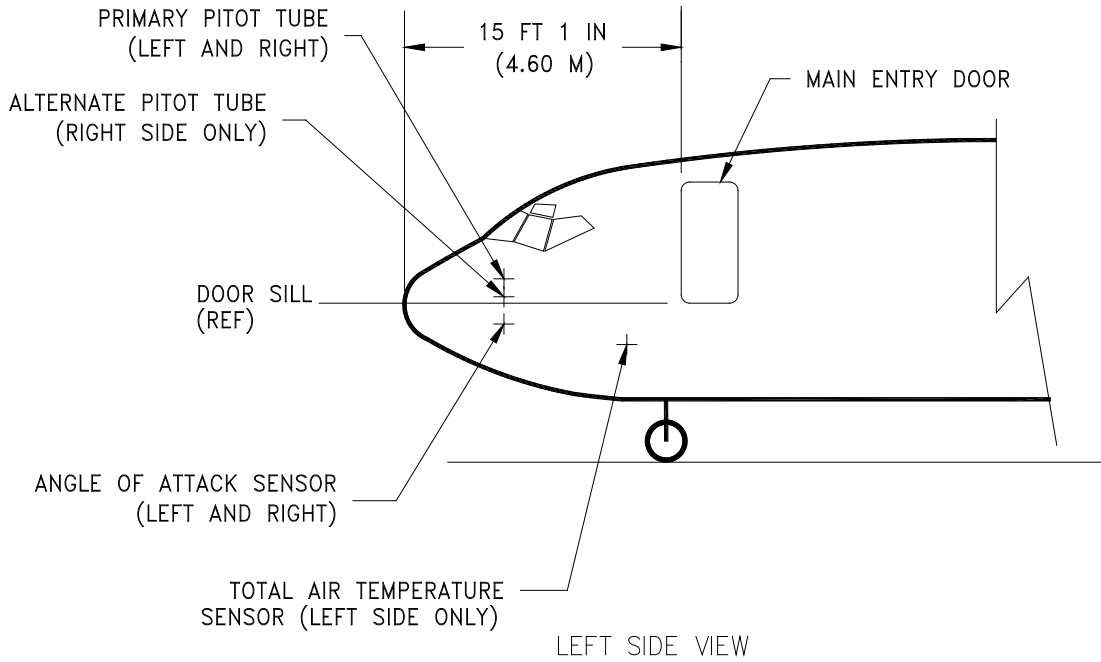

Correction to existing erroneous data; jpc 11 December 2012

NAME OF SENSOR	DISTANCE AFT OF NOSE	DISTANCE ABOVE (+) OR BELOW (-) DOOR SILL REFERENCE LINE	PROTRUSION FROM AIRPLANE SKIN
PRIMARY PITOT-STATIC (L/R)	9 FT 10 IN (3.0 M)	+10 IN (0.25 M)	6 IN (0.15 M)
ALTERNATE PITOT-STATIC (R)	9 FT 10 IN (3.0 M)	-9 IN (-0.23 M)	6 IN (0.15 M)
ANGLE OF ATTACK (L/R)	9 FT 10 IN (3.0 M)	-1 IN (-0.03 M)	4 IN (0.10 M)
TOTAL AIR TEMPERATURE (L)	11 FT 6 IN (3.51 M)	+ 1 FT 6 IN (0.46 M)	4 IN (0.10 M)

2.7.4 Door Clearances: Model 737, All Models, Forward Service Door

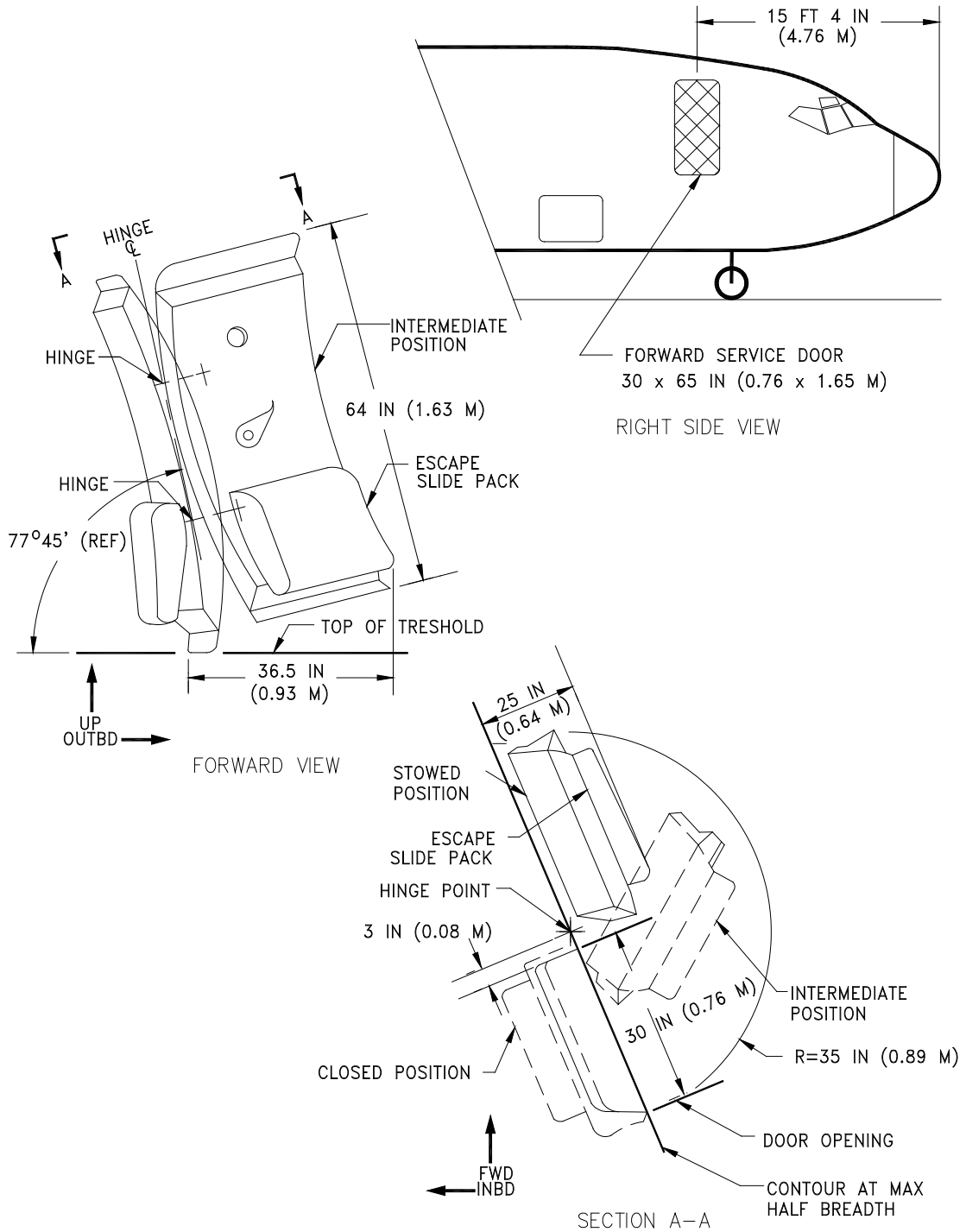

D6-58325-6

REV D

March 2023

2-38

2.7.5 Door Clearances: Model 737, All Models, Aft Entry Door and Aft Service Door

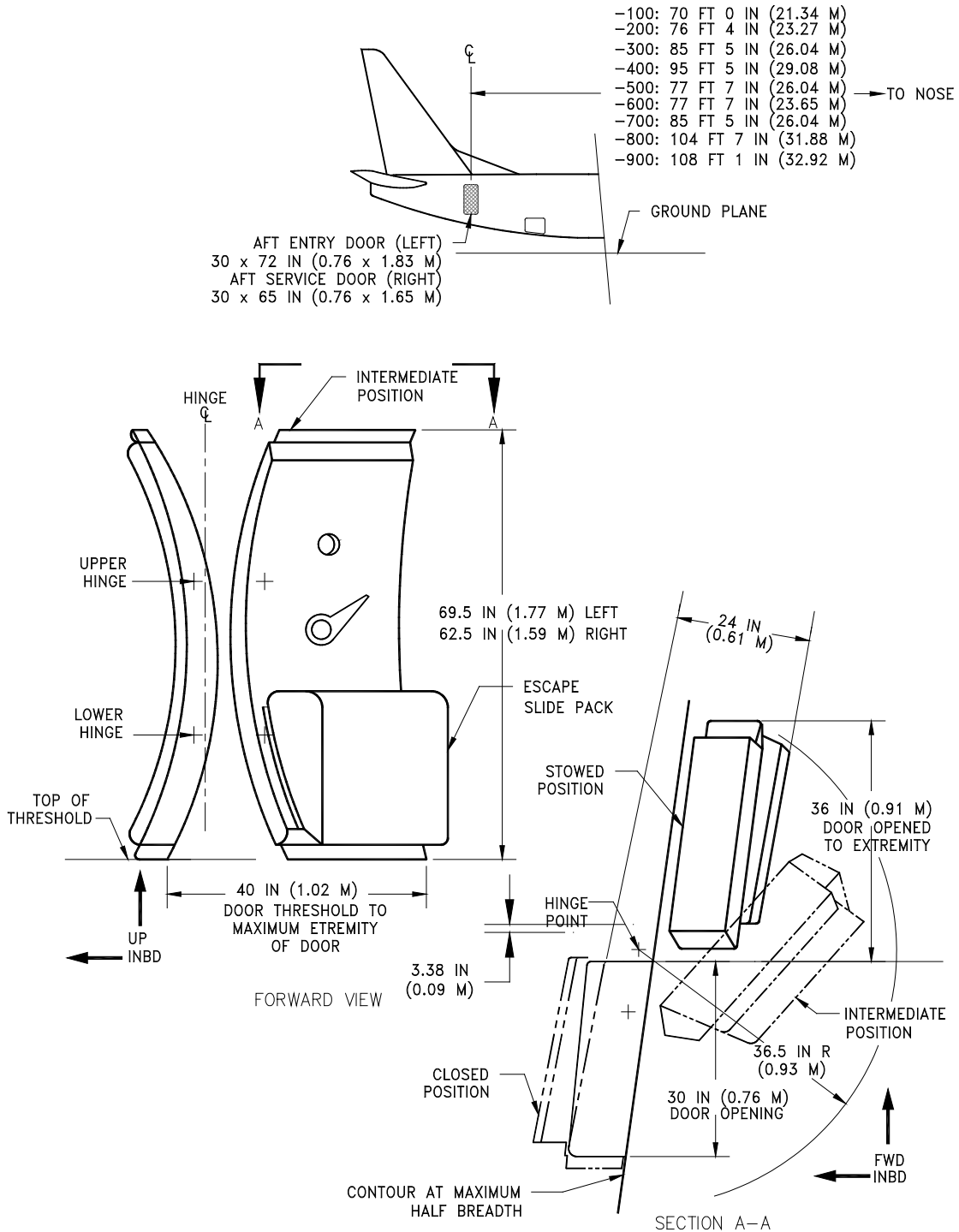

NOTES: 737-800BCF deactivates all Overwing and Aft Entry and Service Doors.

2.7.6 Door Clearances: Model 737-100, -200, Aft Entry Door With Optional Airstair

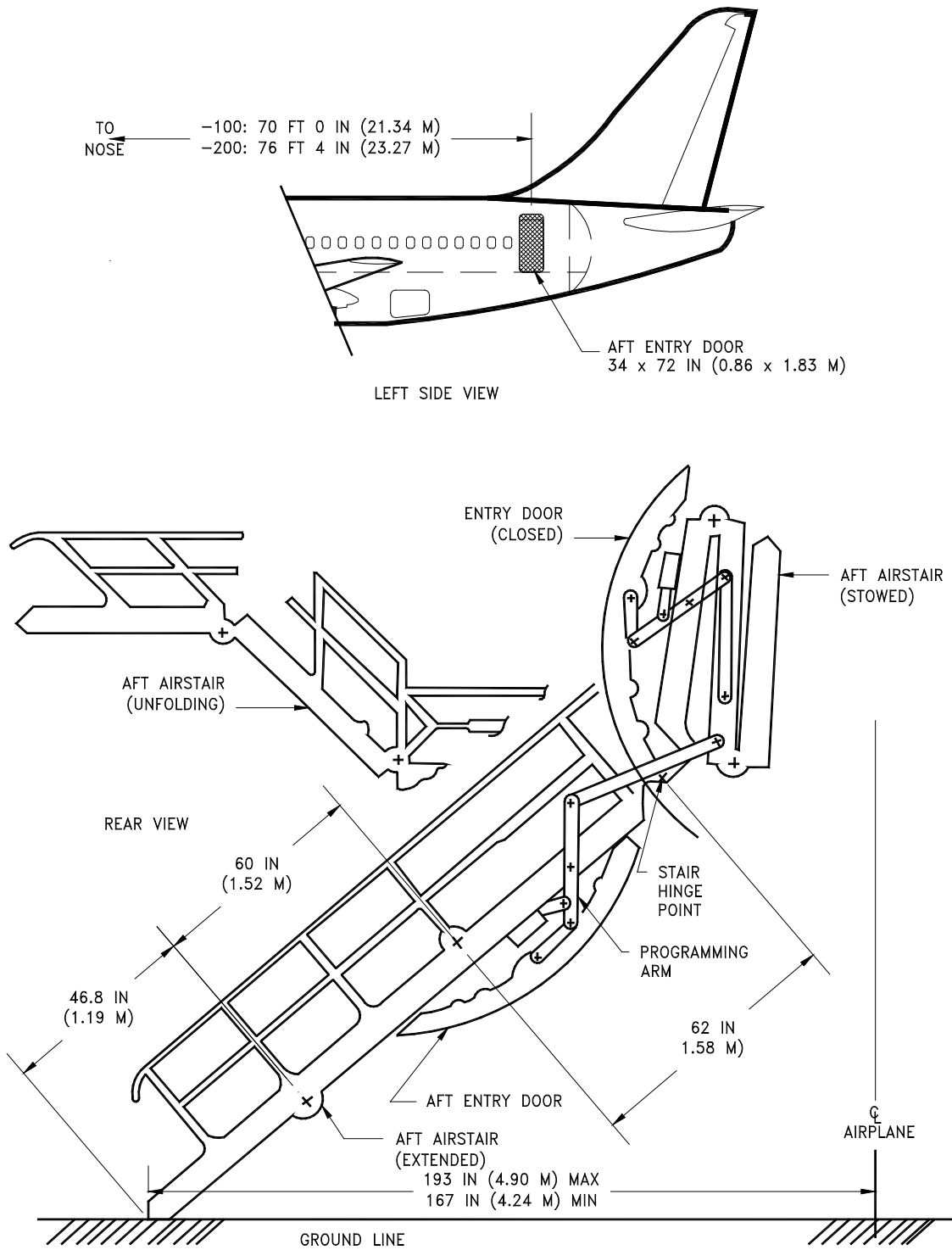

D6-58325-6

REV D

March 2023

2-40

2.7.7 Door Clearances: Model 737, All Models, Lower Deck Cargo Compartments

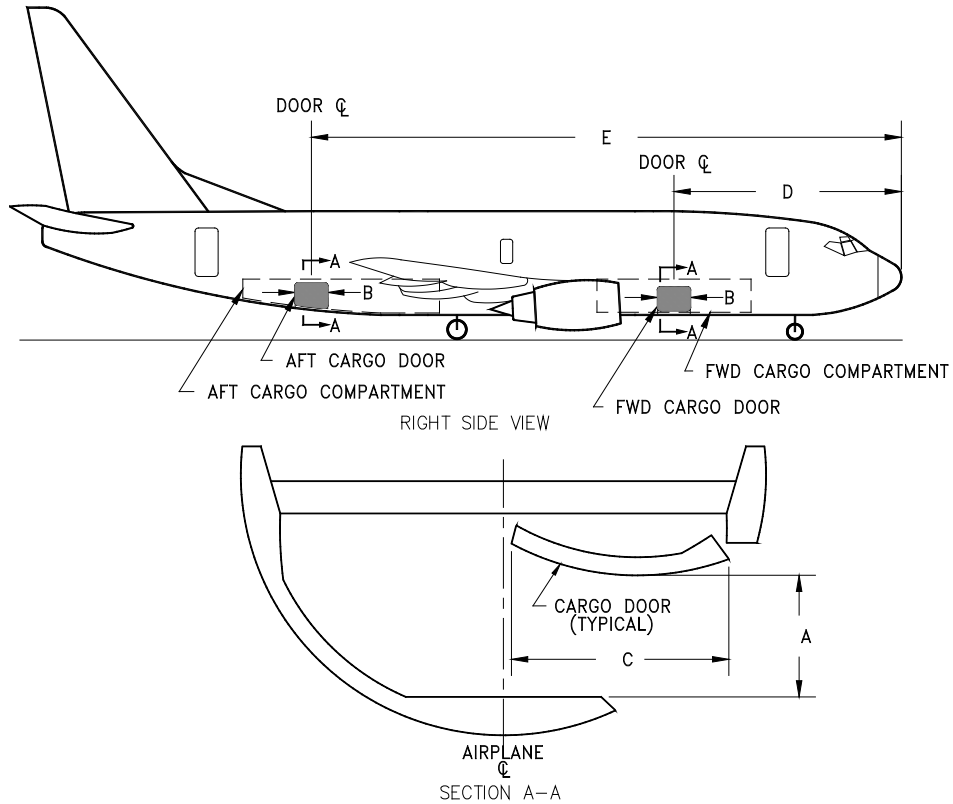

AIRPLANE MODEL	FORWARD CARGO DOOR			AFT CARGO DOOR		
	DOOR SIZE (C x B)	CLEAR OPENING (A x B)	DISTANCE FROM NOSE TO DOOR CL (D)	DOOR SIZE (C x B)	CLEAR OPENING (A x B)	DISTANCE FROM NOSE TO DOOR CL (E)
737-100	51 x 48 IN (1.30 x 1.22 M)	35 x 48 IN (0.89 x 1.22 M)	26 FT 4.5 IN (8.03 M)	48 x 48 IN (1.22 x 1.22 M)	33 x 48 IN (0.84 x 1.22 M)	60 FT 3.5 IN (18.37 M)
737-200	51 x 48 IN (1.30 x 1.22 M)	35 x 48 IN (0.89 x 1.22 M)	28 FT 0.25 IN (8.54 M)	48 x 48 IN (1.22 x 1.22 M)	33 x 48 IN (0.84 x 1.22 M)	63 FT 10.5 IN (19.47 M)
737-300	51 x 48 IN (1.30 x 1.22 M)	35 x 48 IN (0.89 x 1.22 M)	28 FT 0.25 IN (8.54 M)	48 x 48 IN (1.22 x 1.22 M)	33 x 48 IN (0.84 x 1.22 M)	72 FT 6.5 IN (22.11 M)
737-400	51 x 48 IN (1.30 x 1.22 M)	35 x 48 IN (0.89 x 1.22 M)	28 FT 0.25 IN (8.54 M)	48 x 48 IN (1.22 x 1.22 M)	33 x 48 IN (0.84 x 1.22 M)	82 FT 6.5 IN (25.16 M)
737-500	51 x 48 IN (1.30 x 1.22 M)	35 x 48 IN (0.89 x 1.22 M)	24 FT 8.25 IN (7.52 M)	48 x 48 IN (1.22 x 1.22 M)	33 x 48 IN (0.84 x 1.22 M)	64 FT 8.5 IN (19.72 M)

2.7.8 Door Clearances: Model 737-200C, Main Deck Cargo Door

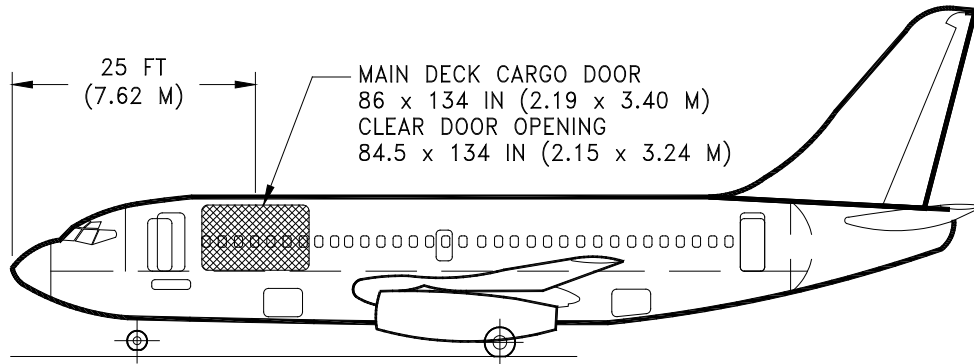

LEFT SIDE VIEW

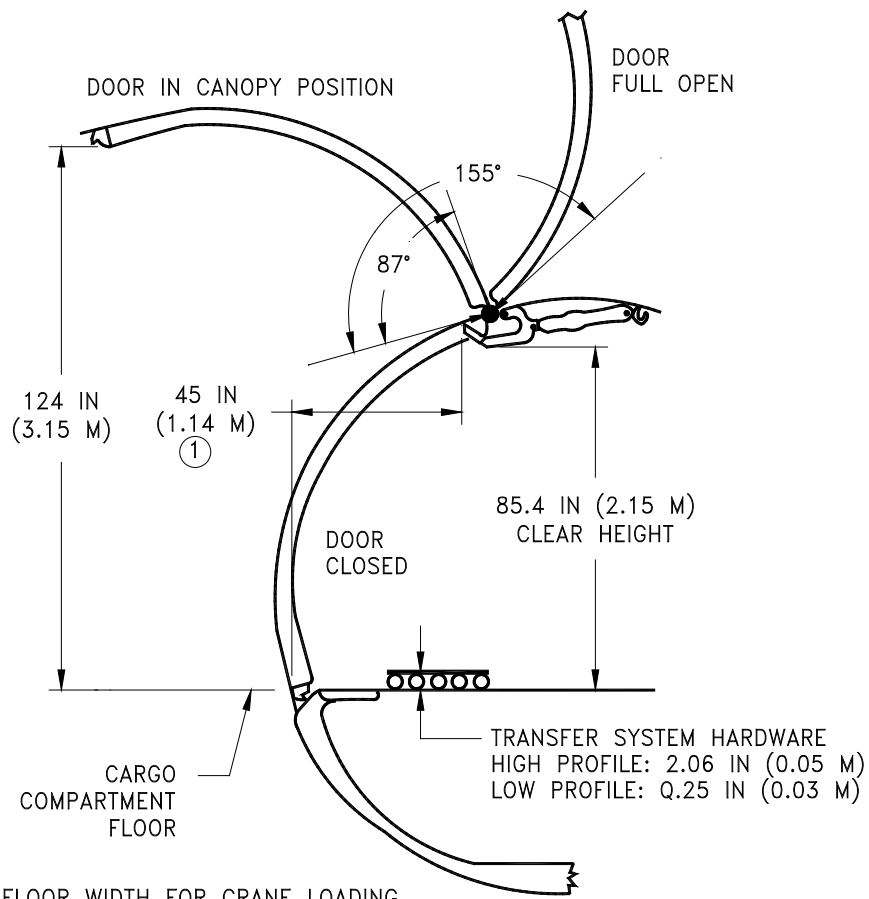

REAR VIEW

NOTE:
 ① EXPOSED FLOOR WIDTH FOR CRANE LOADING
 IN FULL OPEN POSITION

3.0 AIRPLANE PERFORMANCE

3.1 GENERAL INFORMATION

The graphs in Section 3.2 provide information on payload-range capability of the 737 NG airplane. To use these graphs, if the trip range and zero fuel weight (OEW + payload) are known, the approximate takeoff weight can be found, limited by maximum zero fuel weight, maximum design takeoff weight, or fuel capacity.

The graphs in Section 3.3 provide information on FAA/EASA takeoff runway length requirements with typical engines at different pressure altitudes. Maximum takeoff weights shown on the graphs are the heaviest for the particular airplane models with the corresponding engines. Standard day temperatures for pressure altitudes shown on the FAA/EASA takeoff graphs are given below:

PRESSURE ALTITUDE		STANDARD DAY TEMP	
FEET	METERS	°F	°C
0	0	59.0	15.0
2,000	610	51.9	11.0
4,000	1,219	44.7	7.1
6,000	1,829	37.6	3.1
8,000	2,438	30.5	-0.8
10,000	3,048	23.3	-4.8
12,000	3,658	16.2	-8.8
14,000	4,267	9.1	-12.7
15,500	4,724	3.7	-15.7

The graphs in Section 3.4 provide information on landing runway length requirements for different airplane weights and airport altitudes. The maximum landing weights shown are the heaviest for the particular airplane model.

3.2 PAYLOAD/RANGE FOR LONG RANGE CRUISE

3.2.1 Payload/Range for Long Range Cruise: Model 737-100 (JT8D-7 Engines)

NOTES:

- * DOMESTIC RESERVES
- * JT9D-7 ENGINES
- * STANDARD DAY, ZERO WIND
- * LRC AT 30,000 FEET (9,150 METERS)
- * CONSULT WITH USING AIRLINE FOR SPECIFIC OPERATING PROCEDURE PRIOR TO FACILITY DESIGN

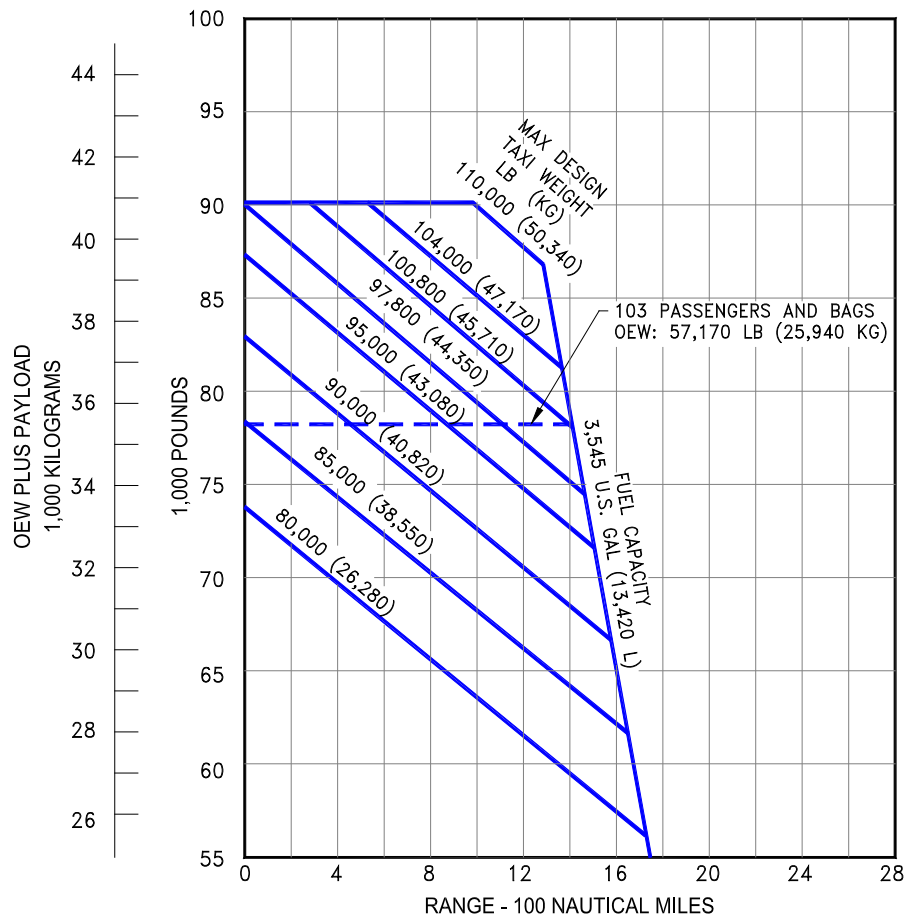

* FOR TAKEOFF WEIGHT, SUBTRACT 500 LB (227 KG) FROM TAXI WEIGHT

3.2.2 Payload/Range for Long Range Cruise: Model 737-200 (JT8D-9/9A Engines)

NOTES:

- * DOMESTIC RESERVES
- * JT9D-9/9A ENGINES
- * STANDARD DAY, ZERO WIND
- * LRC AT 30,000 FEET (9,150 METERS)
- * CONSULT WITH USING AIRLINE FOR SPECIFIC OPERATING PROCEDURE PRIOR TO FACILITY DESIGN

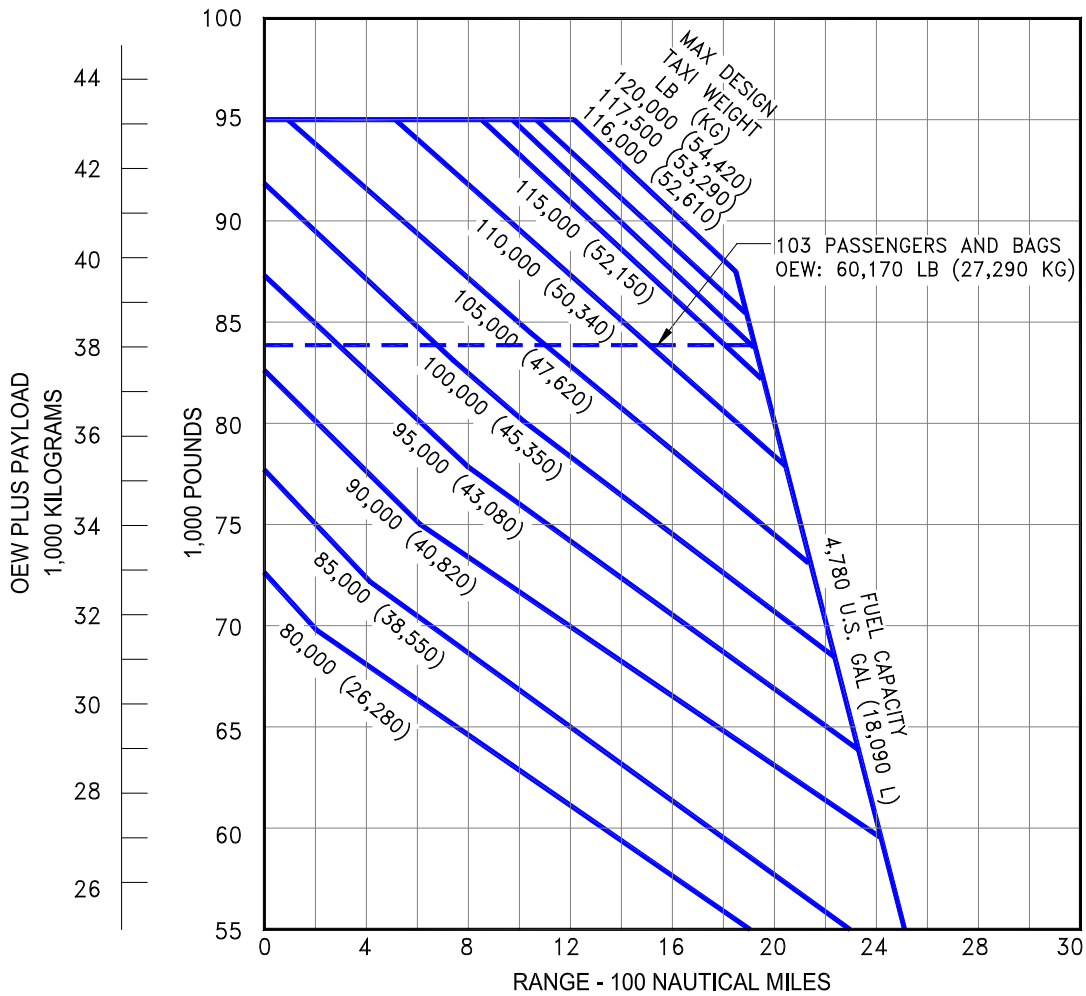

* FOR TAKEOFF WEIGHT, SUBTRACT 500 LB (227 KG) FROM TAXI WEIGHT

3.2.3 Payload/Range for Long Range Cruise: Model 737-200 (JT8D-15/15A Engines)

NOTES:

- * DOMESTIC RESERVES
- * JT9D-15/15A ENGINES
- * STANDARD DAY, ZERO WIND
- * LRC AT 30,000 FEET (9,150 METERS)
- * CONSULT WITH USING AIRLINE FOR SPECIFIC OPERATING PROCEDURE PRIOR TO FACILITY DESIGN

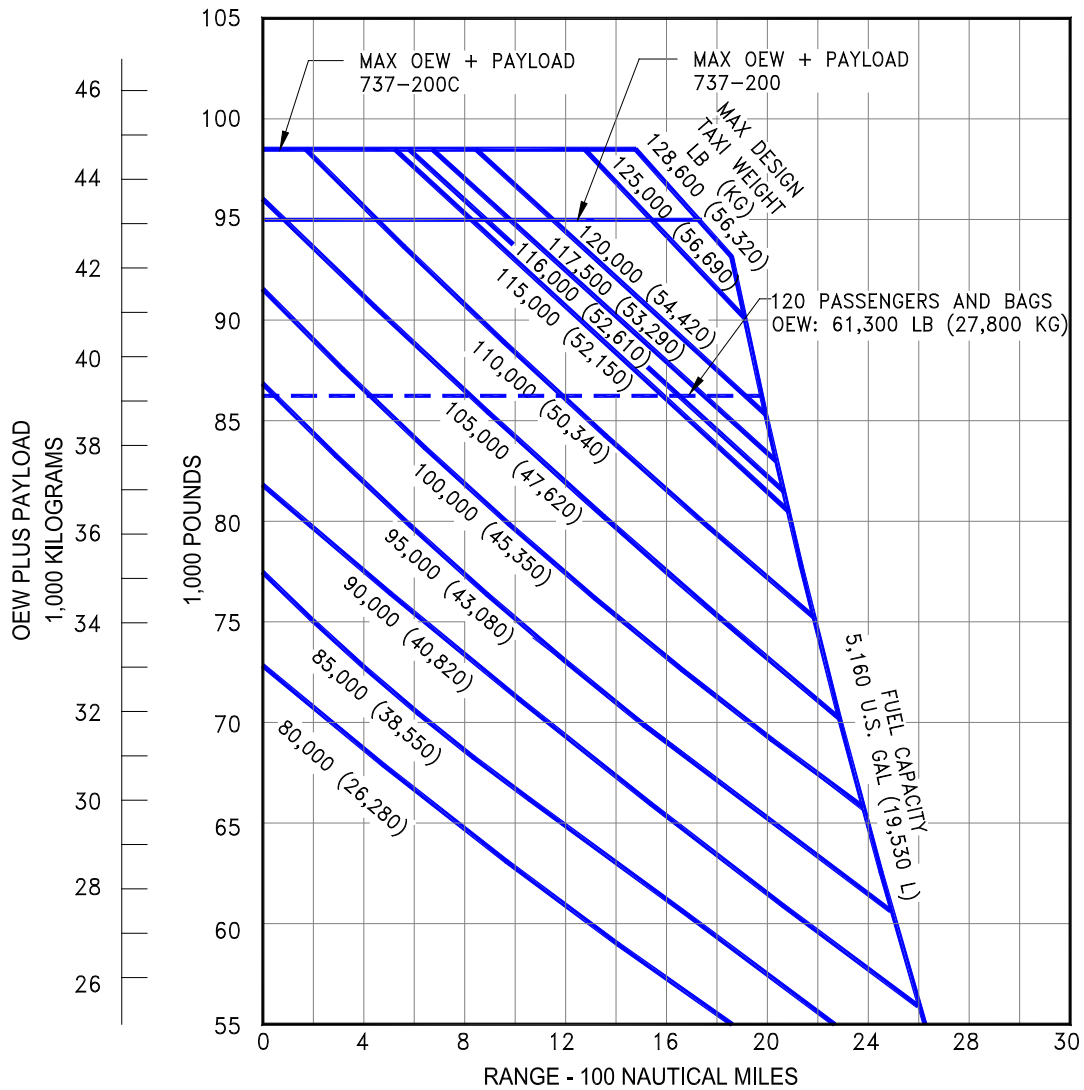

* FOR TAKEOFF WEIGHT, SUBTRACT 500 LB (227 KG) FROM TAXI WEIGHT

3.2.4 Payload/Range for Long Range Cruise: Model 737-200ADV (JT8D-17/17A Engines)

NOTES:

- * DOMESTIC RESERVES
- * JT9D-17/17A ENGINES
- * STANDARD DAY, ZERO WIND
- * LRC AT 30,000 FEET (9,150 METERS)
- * CONSULT WITH USING AIRLINE FOR SPECIFIC OPERATING PROCEDURE PRIOR TO FACILITY DESIGN

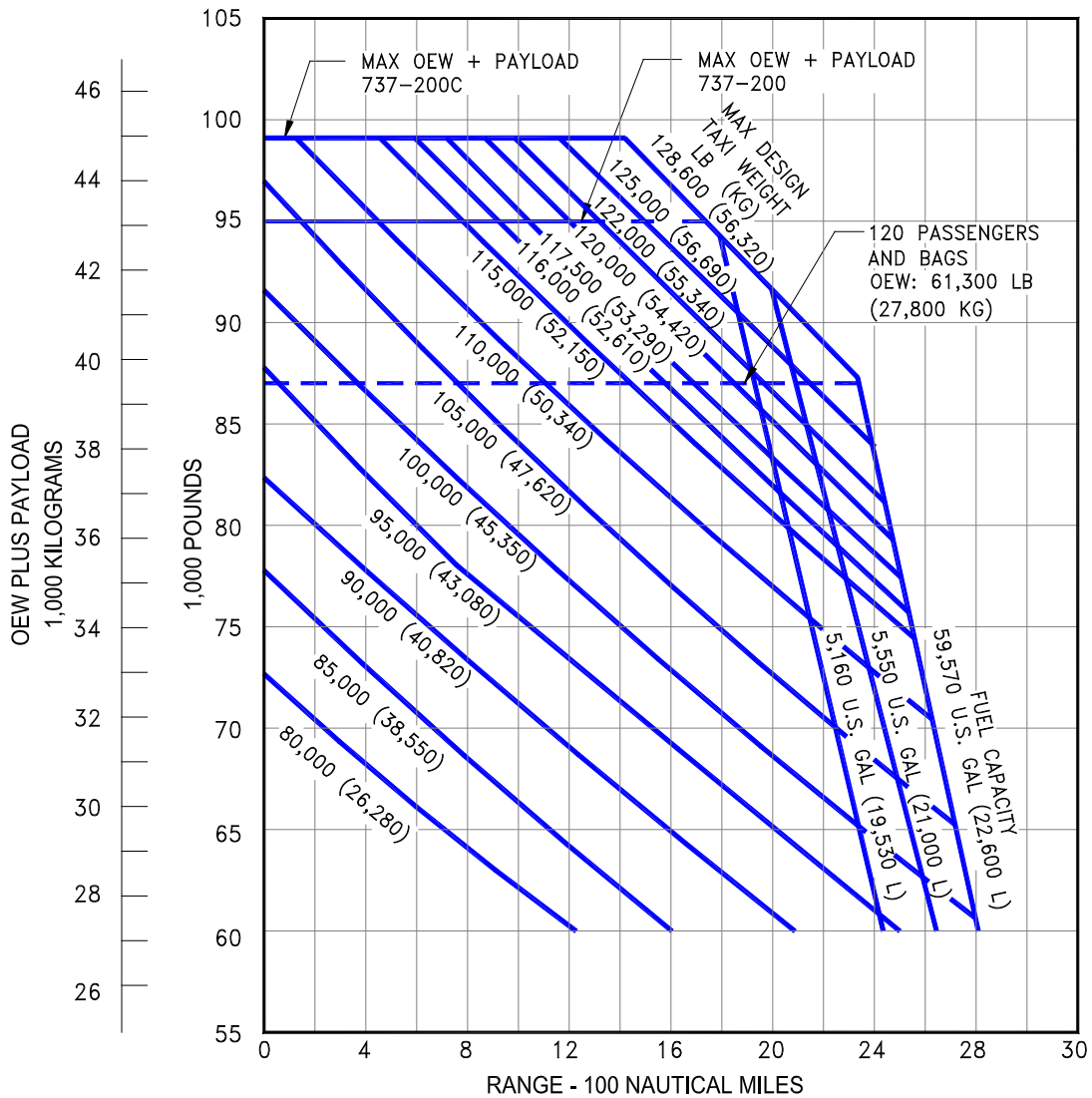

* FOR TAKEOFF WEIGHT, SUBTRACT 500 LB (227 KG) FROM TAXI WEIGHT

3.2.5 Payload/Range for Long Range Cruise: Model 737-200ADV (JT8D-17R/17AR Engines)

NOTES:

- * DOMESTIC RESERVES
- * JT9D-17R/17AR ENGINES
- * STANDARD DAY, ZERO WIND
- * LRC AT 30,000 FEET (9,150 METERS)
- * CONSULT WITH USING AIRLINE FOR SPECIFIC OPERATING PROCEDURE PRIOR TO FACILITY DESIGN

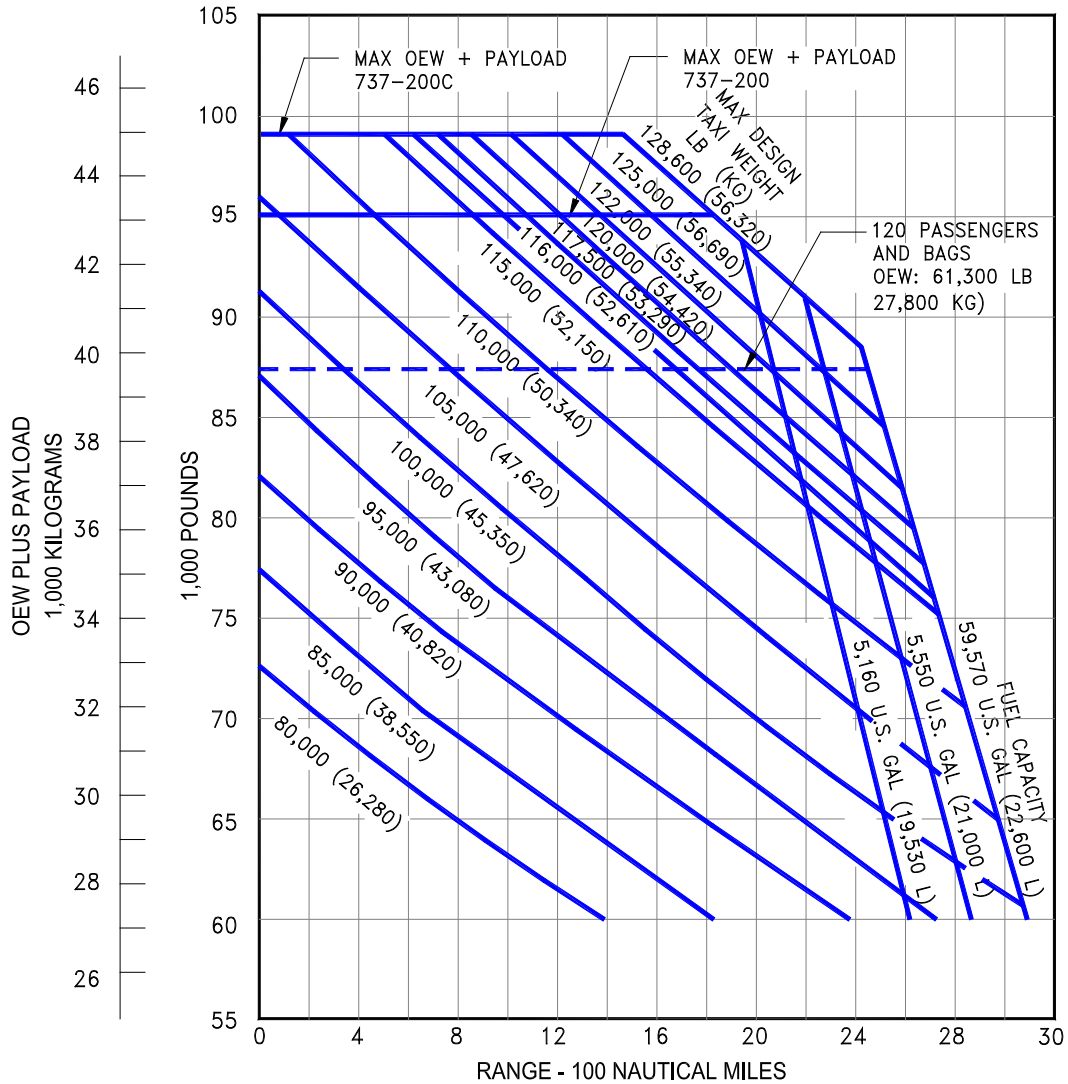

* FOR TAKEOFF WEIGHT, SUBTRACT 500 LB (227 KG) FROM TAXI WEIGHT

3.2.6 Payload/Range for Long Range Cruise: Model 737-300

NOTES:

- * DOMESTIC RESERVES
- * CFM56-3B-1 OR CFM56-3B-2 ENGINES
- * STANDARD DAY, ZERO WIND
- * LRC AT 31,000/35,000 FEET
- * CONSULT USING AIRLINE FOR SPECIFIC OPERATING PROCEDURE PRIOR TO FACILITY DESIGN

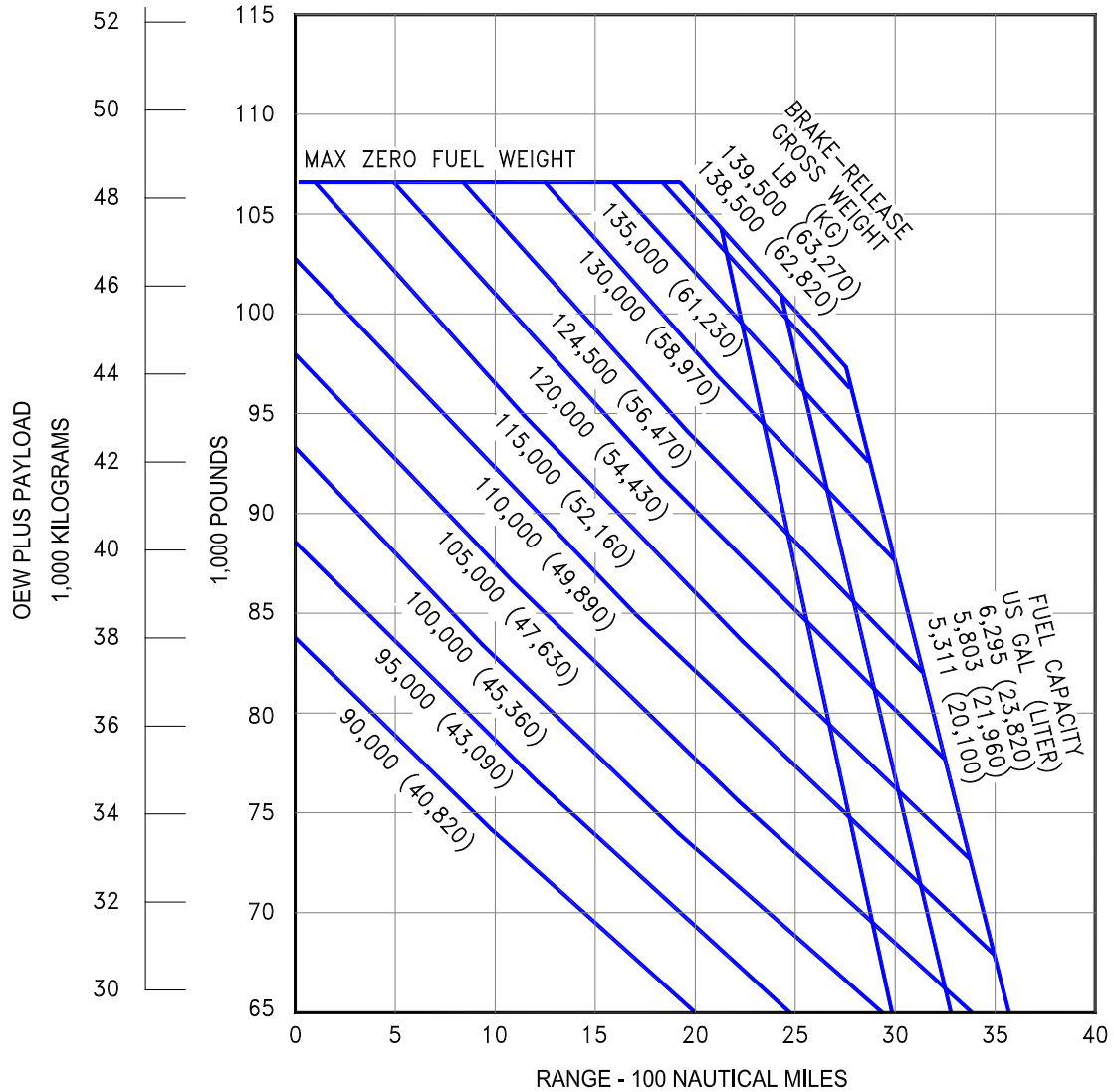

3.2.7 Payload/Range for Long Range Cruise: Model 737-400

NOTES:

- * DOMESTIC RESERVES
- * CFM56-3B-2 OR CFM56-3C-1 ENGINES
- * STANDARD DAY, ZERO WIND
- * LRC AT 31,000/35,000 FEET
- * CONSULT USING AIRLINE FOR SPECIFIC OPERATING PROCEDURE PRIOR TO FACILITY DESIGN

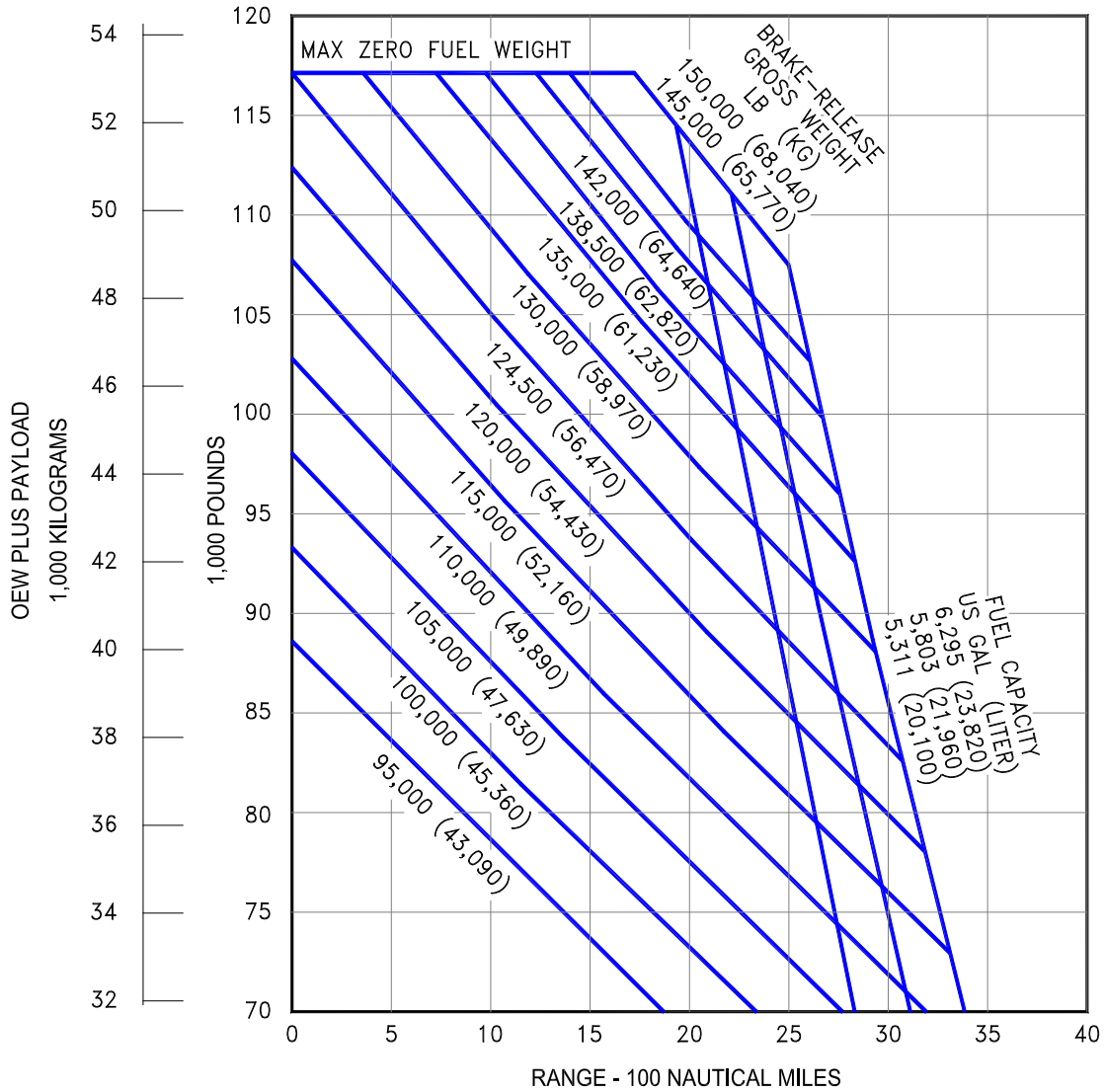

3.2.8 Payload/Range for Long Range Cruise: Model 737-500

NOTES:

- * DOMESTIC RESERVES
- * CFM56-3B-1 ENGINES
- * STANDARD DAY, ZERO WIND
- * LRC AT 31,000/35,000 FEET
- * CONSULT USING AIRLINE FOR SPECIFIC OPERATING PROCEDURE PRIOR TO FACILITY DESIGN

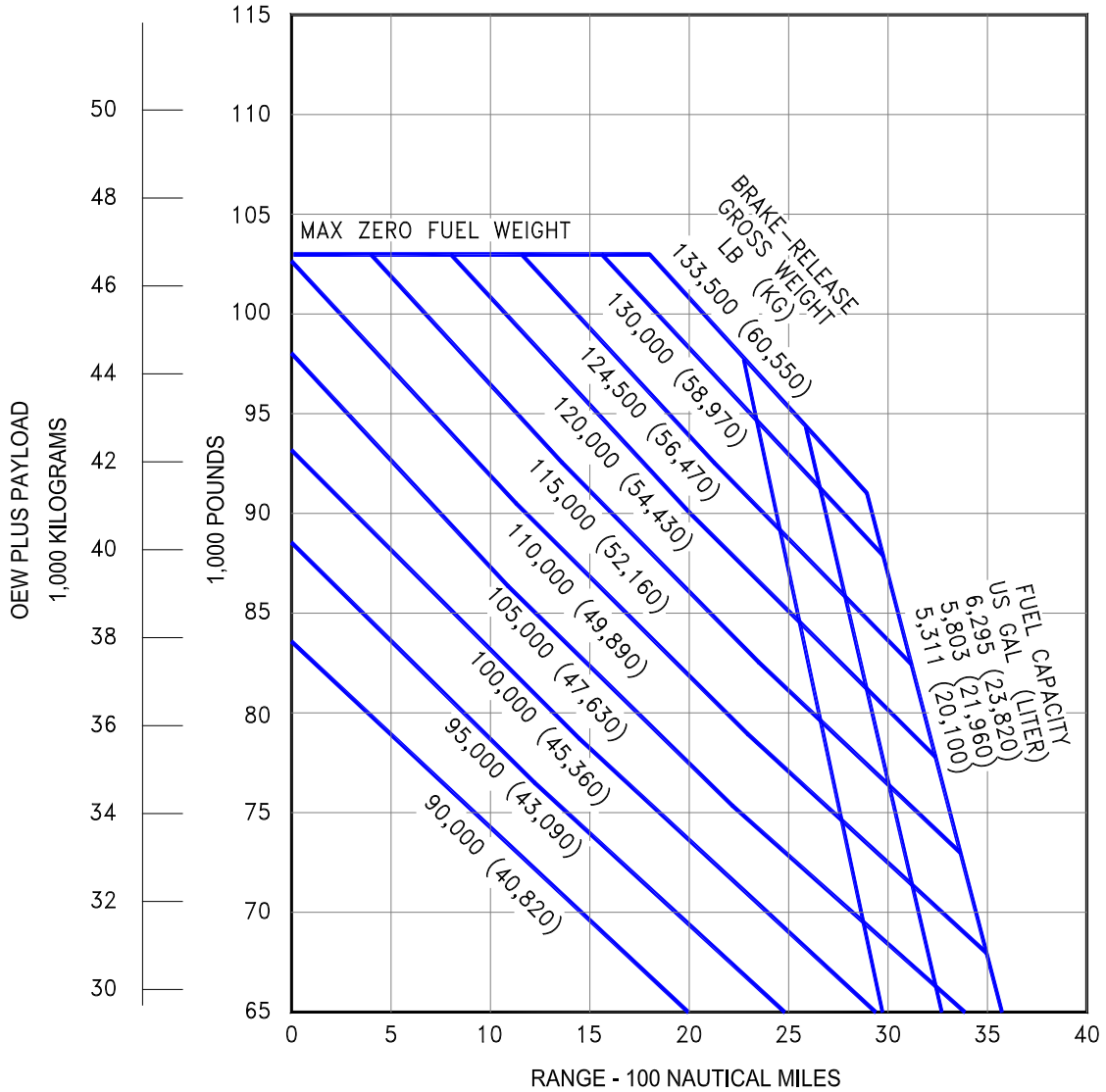

3.3 F.A.R. AND J.A.R. TAKEOFF RUNWAY LENGTH REQUIREMENTS

3.3.1 F.A.R. Takeoff Runway Length Requirements - Standard Day: Model 737-100 (JT8D-7 Engines)

NOTES:

- * NO ENGINE AIRBLEED FOR AIR CONDITIONING
- * ZERO WIND, ZERO RUNWAY GRADIENT
- * CONSULT USING AIRLINE FOR SPECIFIC OPERATING PROCEDURE PRIOR TO FACILITY DESIGN
- * JT8D-7 ENGINES

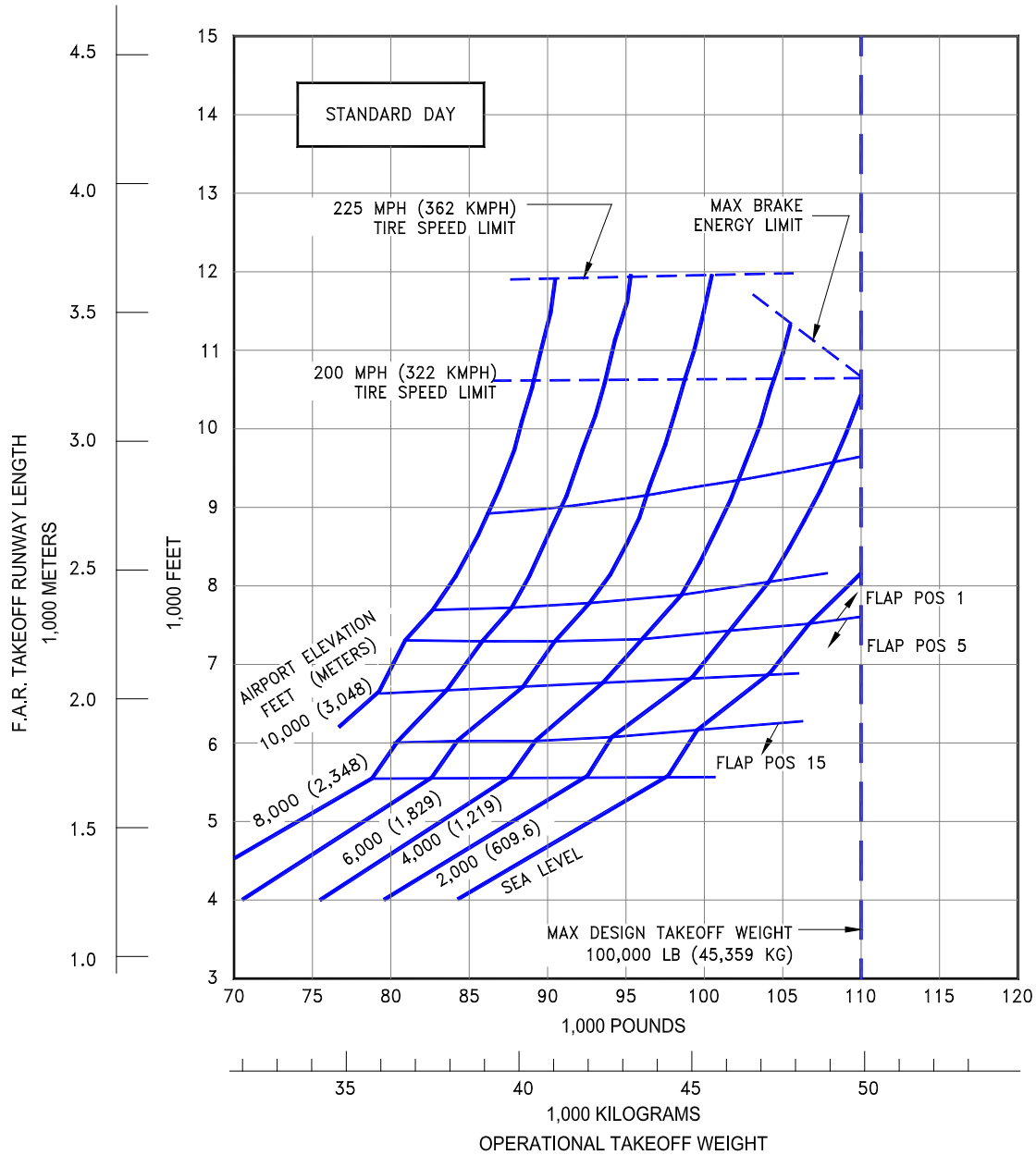

D6-58325-6

3.3.2 F.A.R. Takeoff Runway Length Requirements - Standard Day + 27°F (STD + 15°C): Model 737-100 (JT8D-7 Engines)

NOTES:

- * NO ENGINE AIRBLEED FOR AIR CONDITIONING
- * ZERO WIND, ZERO RUNWAY GRADIENT
- * CONSULT USING AIRLINE FOR SPECIFIC OPERATING PROCEDURE PRIOR TO FACILITY DESIGN
- * JT8D-7 ENGINES

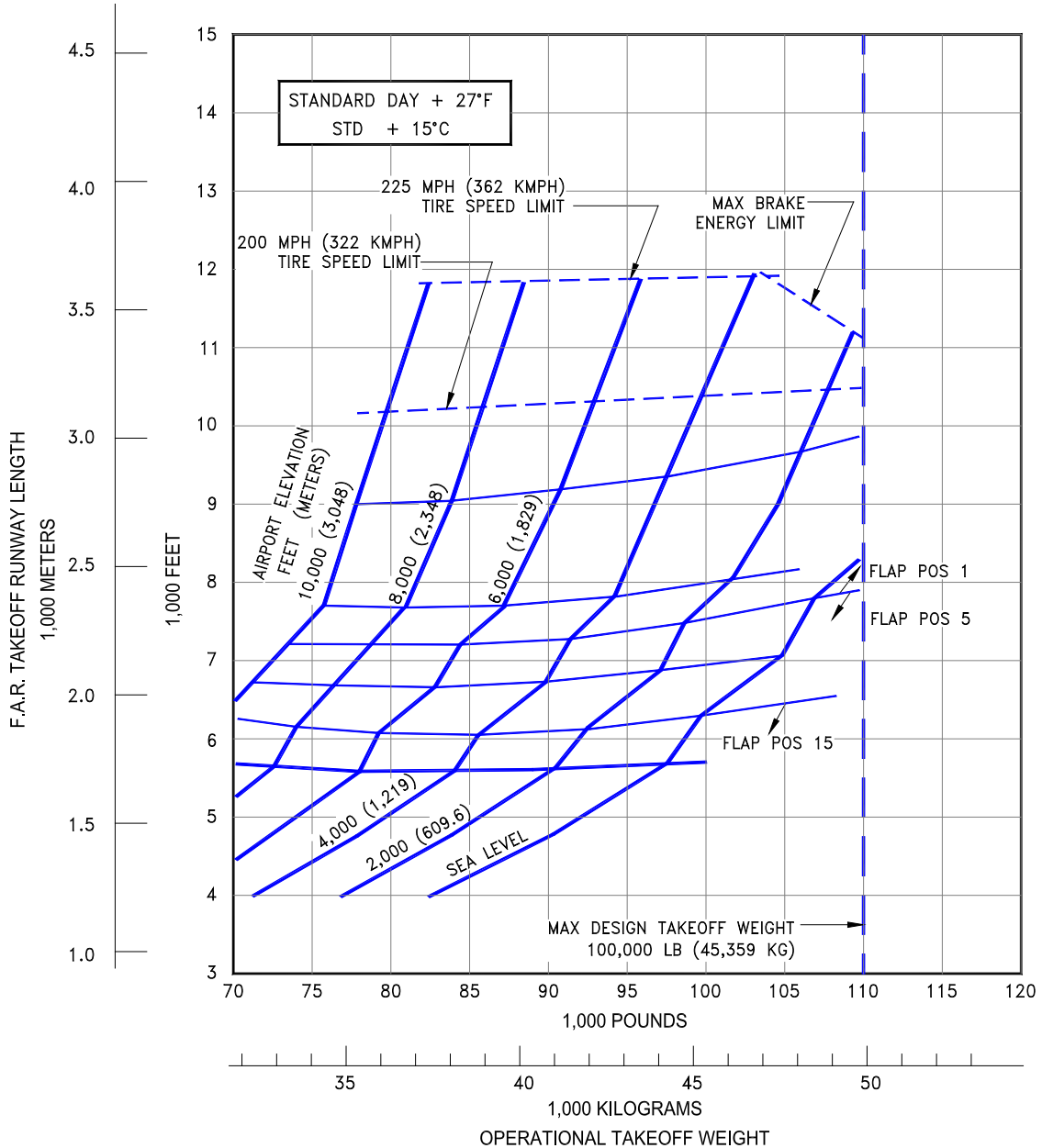

D6-58325-6

3.3.3 F.A.R. Takeoff Runway Length Requirements – Standard Day: Model 737-200 (JT8D-9/9A Engines)

NOTES:

- * NO ENGINE AIRBLEED FOR AIR CONDITIONING
- * ZERO WIND, ZERO RUNWAY GRADIENT
- * CONSULT USING AIRLINE FOR SPECIFIC OPERATING PROCEDURE PRIOR TO FACILITY DESIGN
- * JT8D-9/9A ENGINES

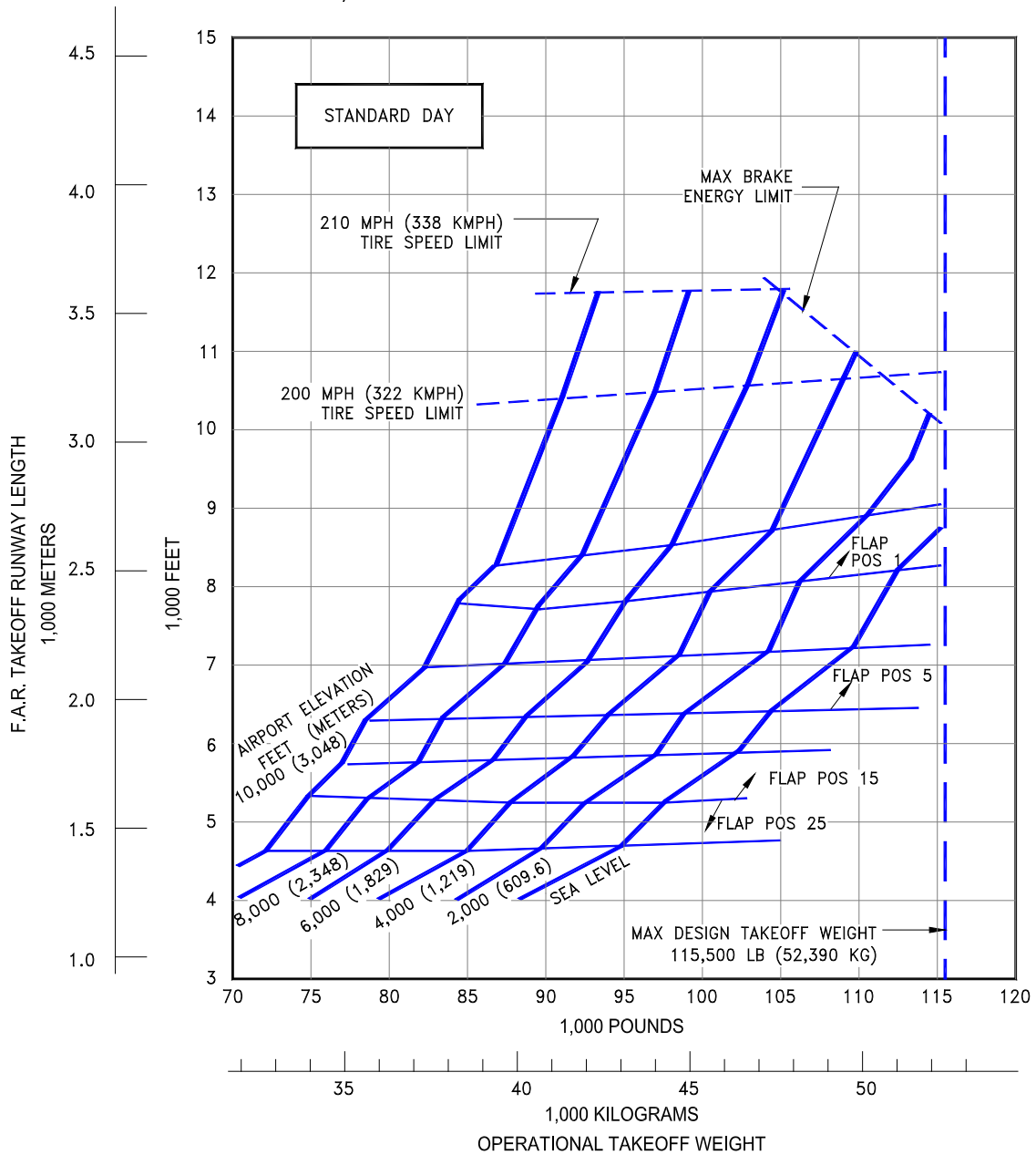

D6-58325-6

3.3.4 F.A.R. Takeoff Runway Length Requirements - Standard Day + 27°F (STD + 15°C): Model 737-200 (JT8D-9/9A Engines)

NOTES:

- * NO ENGINE AIRBLEED FOR AIR CONDITIONING
- * ZERO WIND, ZERO RUNWAY GRADIENT
- * CONSULT USING AIRLINE FOR SPECIFIC OPERATING PROCEDURE PRIOR TO FACILITY DESIGN
- * JT8D-9/9A ENGINES

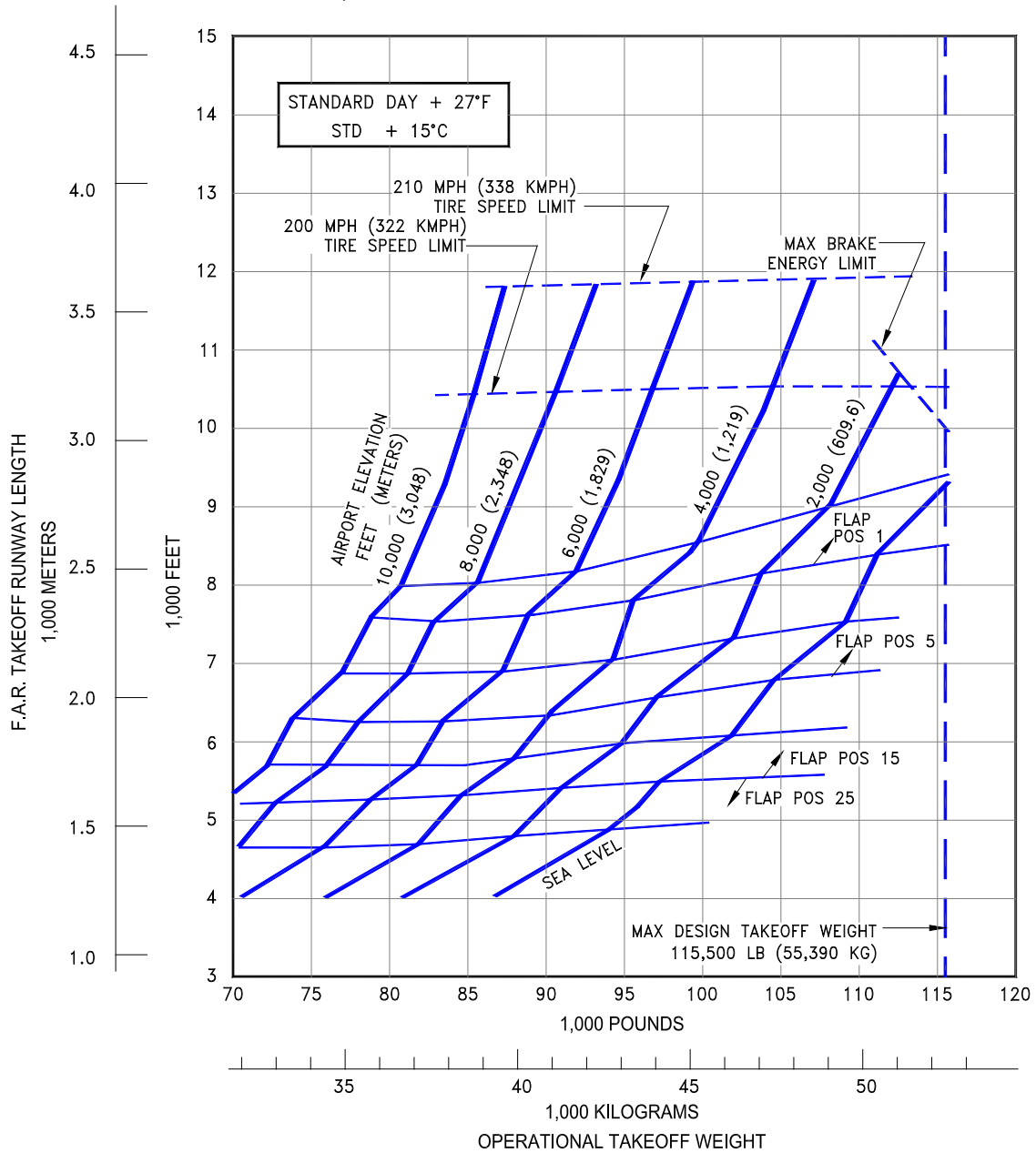

D6-58325-6

3.3.5 F.A.R. Takeoff Runway Length Requirements - Standard Day: Model 737-200ADV (JT8D-15/15A Engines)

NOTES:

- * NO ENGINE AIRBLEED FOR AIR CONDITIONING
- * ZERO WIND, ZERO RUNWAY GRADIENT
- * CONSULT USING AIRLINE FOR SPECIFIC OPERATING PROCEDURE PRIOR TO FACILITY DESIGN
- * JT8D-15/15A ENGINES

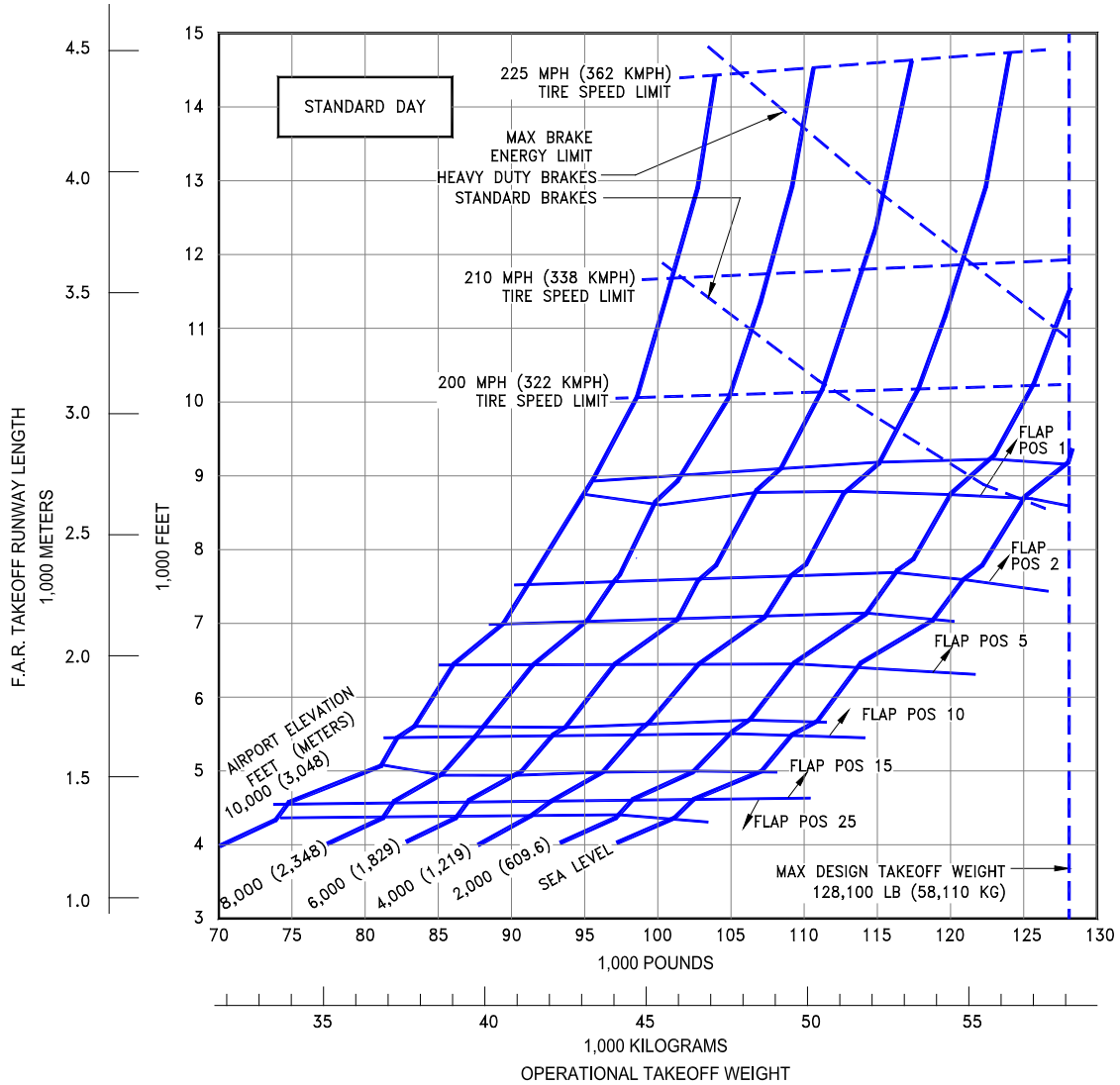

D6-58325-6

3.3.6 F.A.R. Takeoff Runway Length Requirements - Standard Day + 27°F (STD + 15°C): Model 737-200ADV (JT8D-15/15A Engines)

- NOTES:
- * NO ENGINE AIRBLEED FOR AIR CONDITIONING
 - * ZERO WIND, ZERO RUNWAY GRADIENT
 - * CONSULT USING AIRLINE FOR SPECIFIC OPERATING PROCEDURE PRIOR TO FACILITY DESIGN
 - * JT8D-15/15A ENGINES

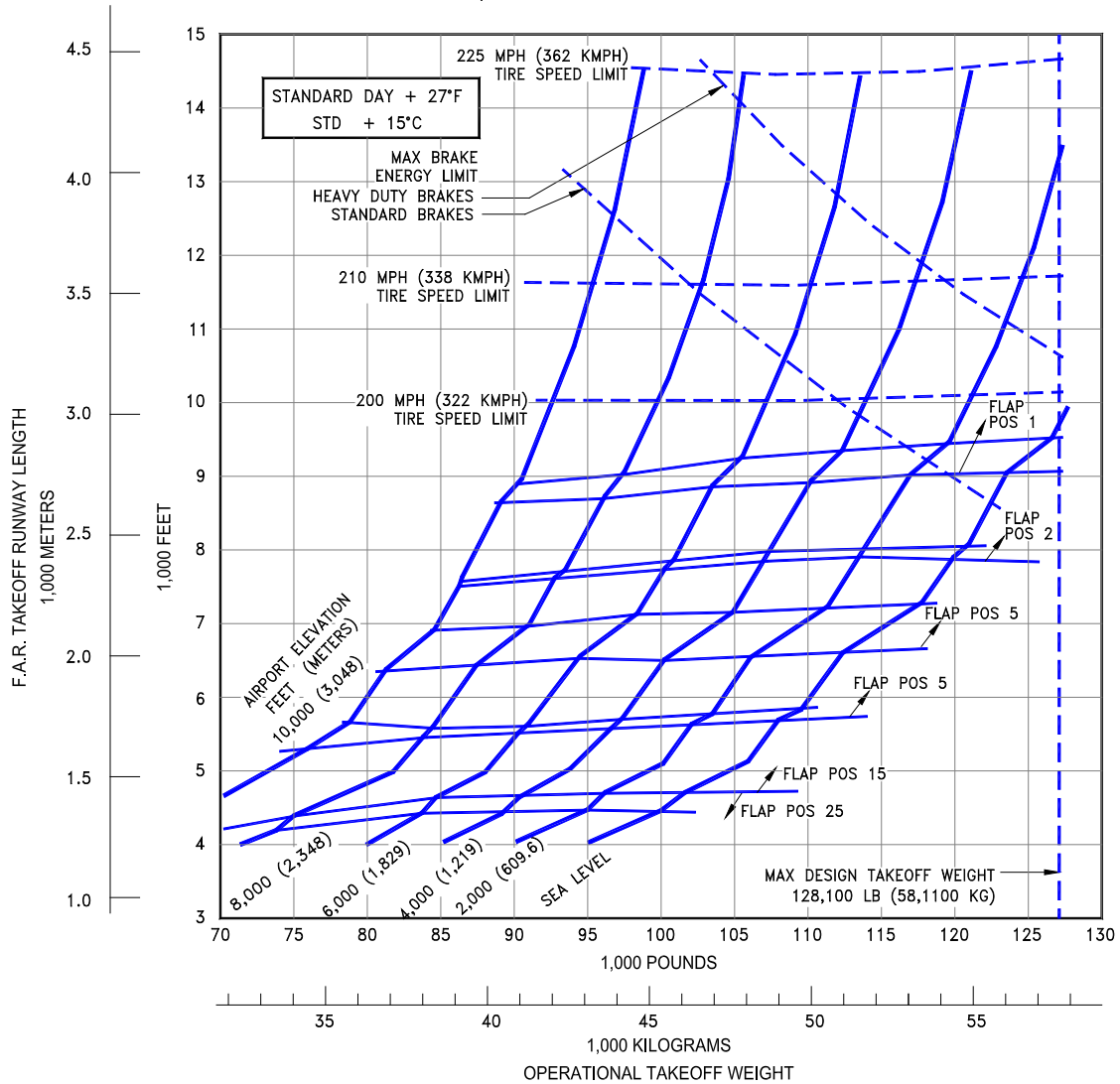

D6-58325-6

3.3.7 F.A.R. Takeoff Runway Length Requirements - Standard Day: Model 737-200ADV (JT8D-17/17A Engines)

NOTES:

- * NO ENGINE AIRBLEED FOR AIR CONDITIONING
- * ZERO WIND, ZERO RUNWAY GRADIENT
- * CONSULT USING AIRLINE FOR SPECIFIC OPERATING PROCEDURE PRIOR TO FACILITY DESIGN
- * JT8D-17/17A ENGINES

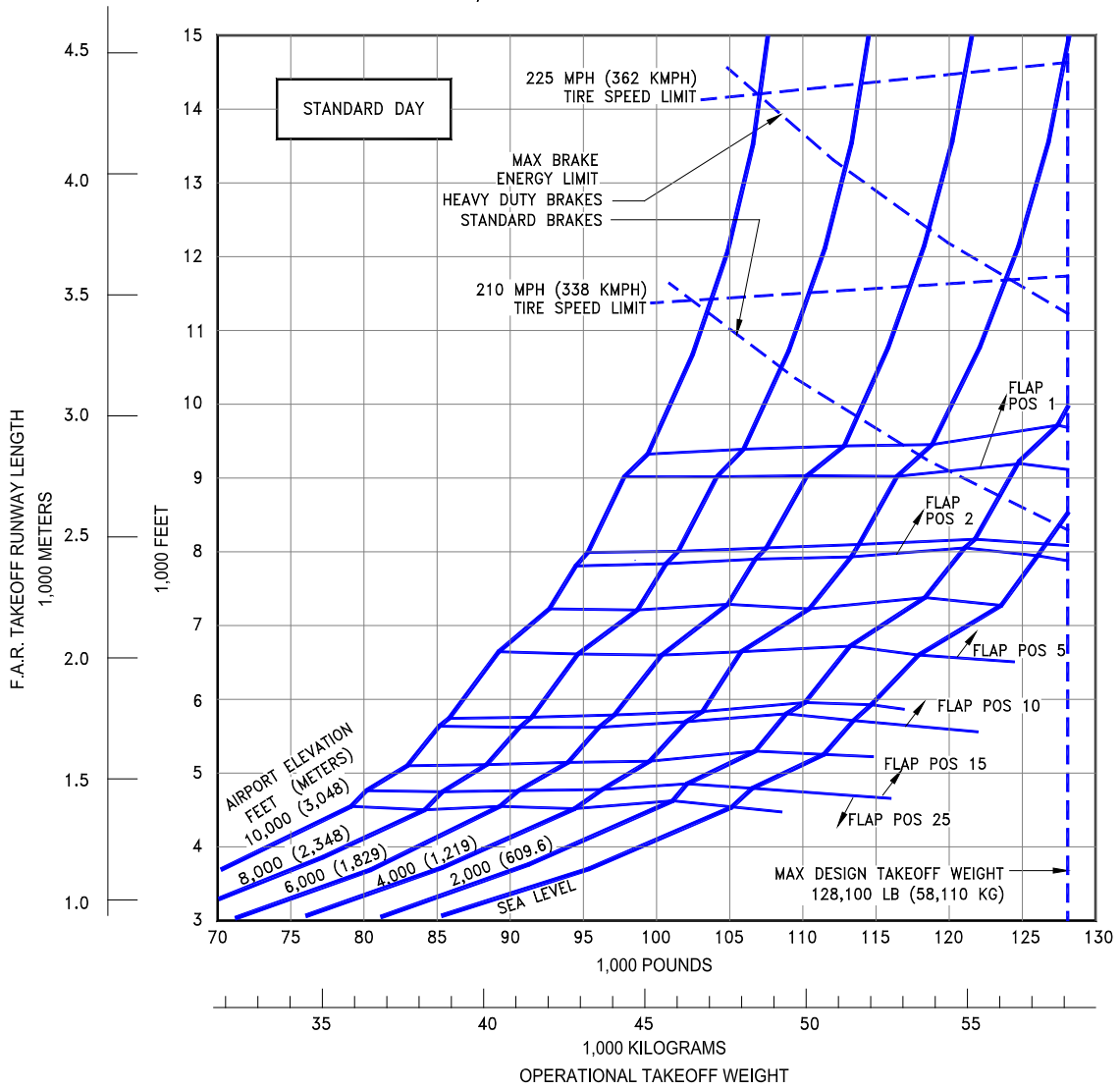

3.3.8 F.A.R. Takeoff Runway Length Requirements - Standard Day + 27°F (STD + 15°C): Model 737-200ADV (JT8D-17/17A Engines)

- NOTES:
- * NO ENGINE AIRBLEED FOR AIR CONDITIONING
 - * ZERO WIND, ZERO RUNWAY GRADIENT
 - * CONSULT USING AIRLINE FOR SPECIFIC OPERATING PROCEDURE PRIOR TO FACILITY DESIGN
 - * JT8D-17/17A ENGINES

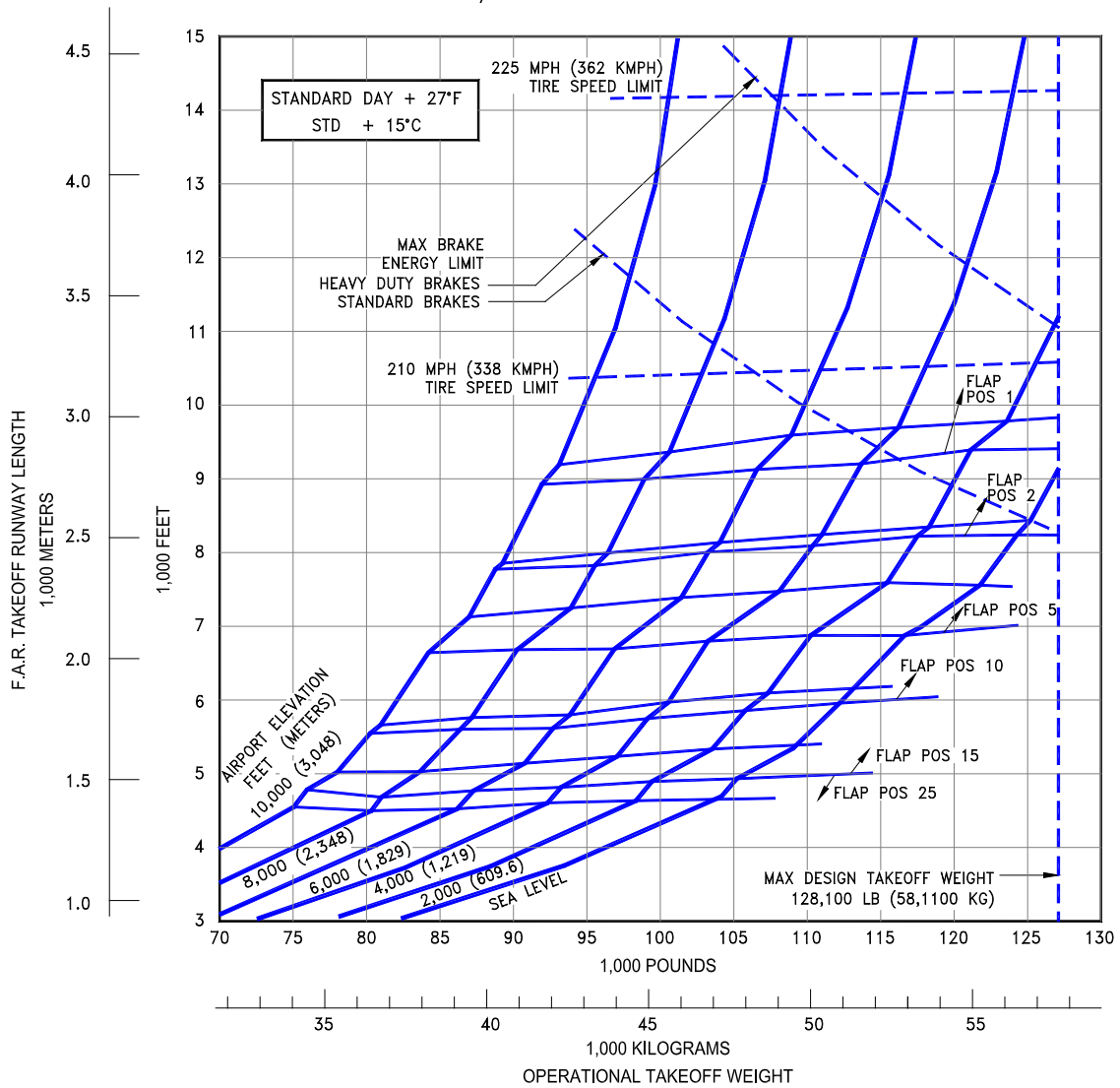

D6-58325-6

3.3.9 F.A.R. Takeoff Runway Length Requirements - Standard Day: Model 737-200ADV (JT8D-17R/17AR Engines)

- NOTES:
- * NO ENGINE AIRBLED FOR AIR CONDITIONING
 - * ZERO WIND, ZERO RUNWAY GRADIENT
 - * CONSULT USING AIRLINE FOR SPECIFIC OPERATING PROCEDURE PRIOR TO FACILITY DESIGN
 - * JT8D-17R/17AR ENGINES

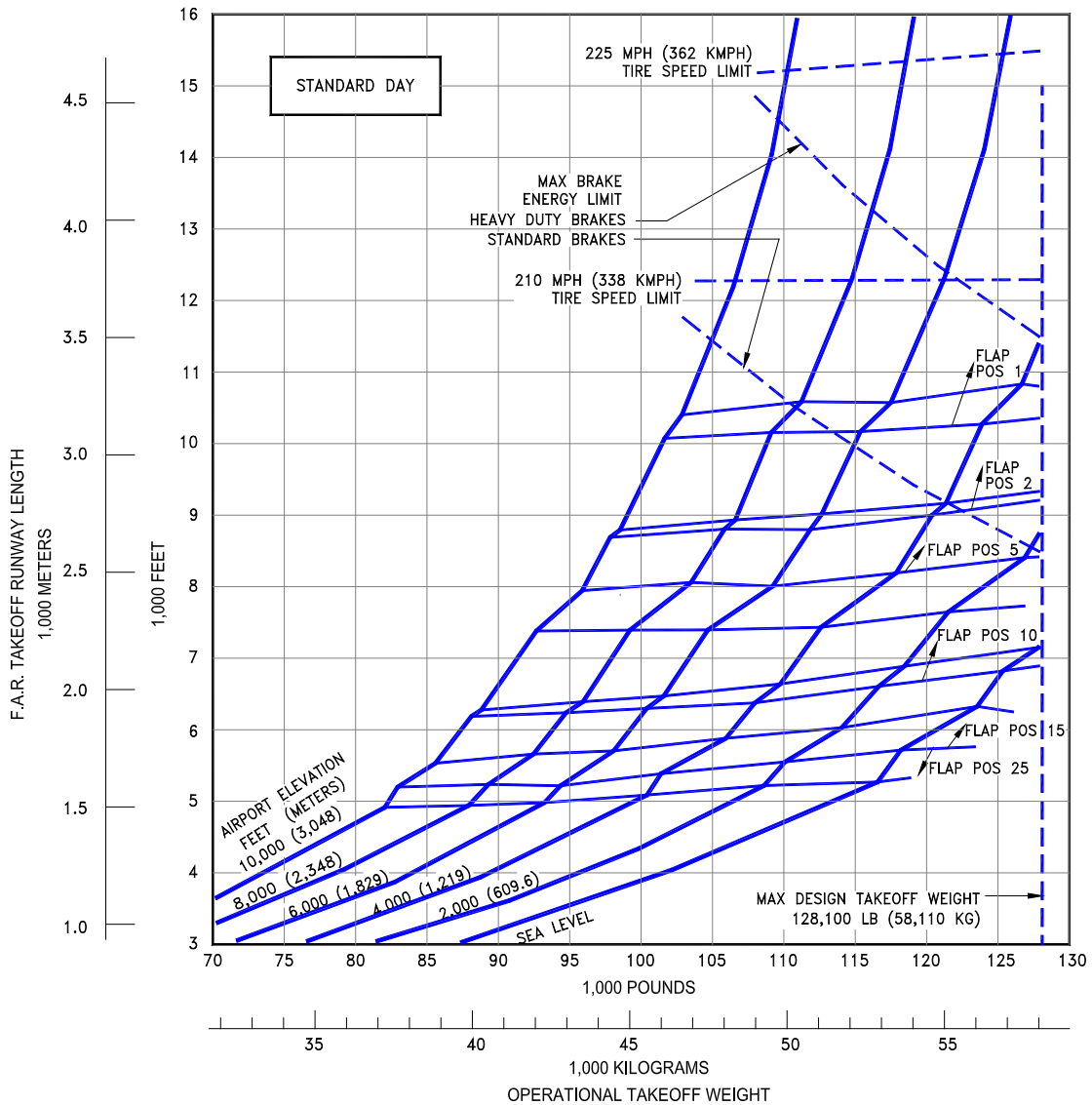

D6-58325-6

3.3.10 F.A.R. Takeoff Runway Length Requirements - Standard Day + 27°F (STD + 15°C): Model 737-200ADV (JT8D-17R/17AR Engines)

NOTES:

- * NO ENGINE AIRBLEED FOR AIR CONDITIONING
- * ZERO WIND, ZERO RUNWAY GRADIENT
- * CONSULT USING AIRLINE FOR SPECIFIC OPERATING PROCEDURE PRIOR TO FACILITY DESIGN
- * JT8D-17R/17AR ENGINES

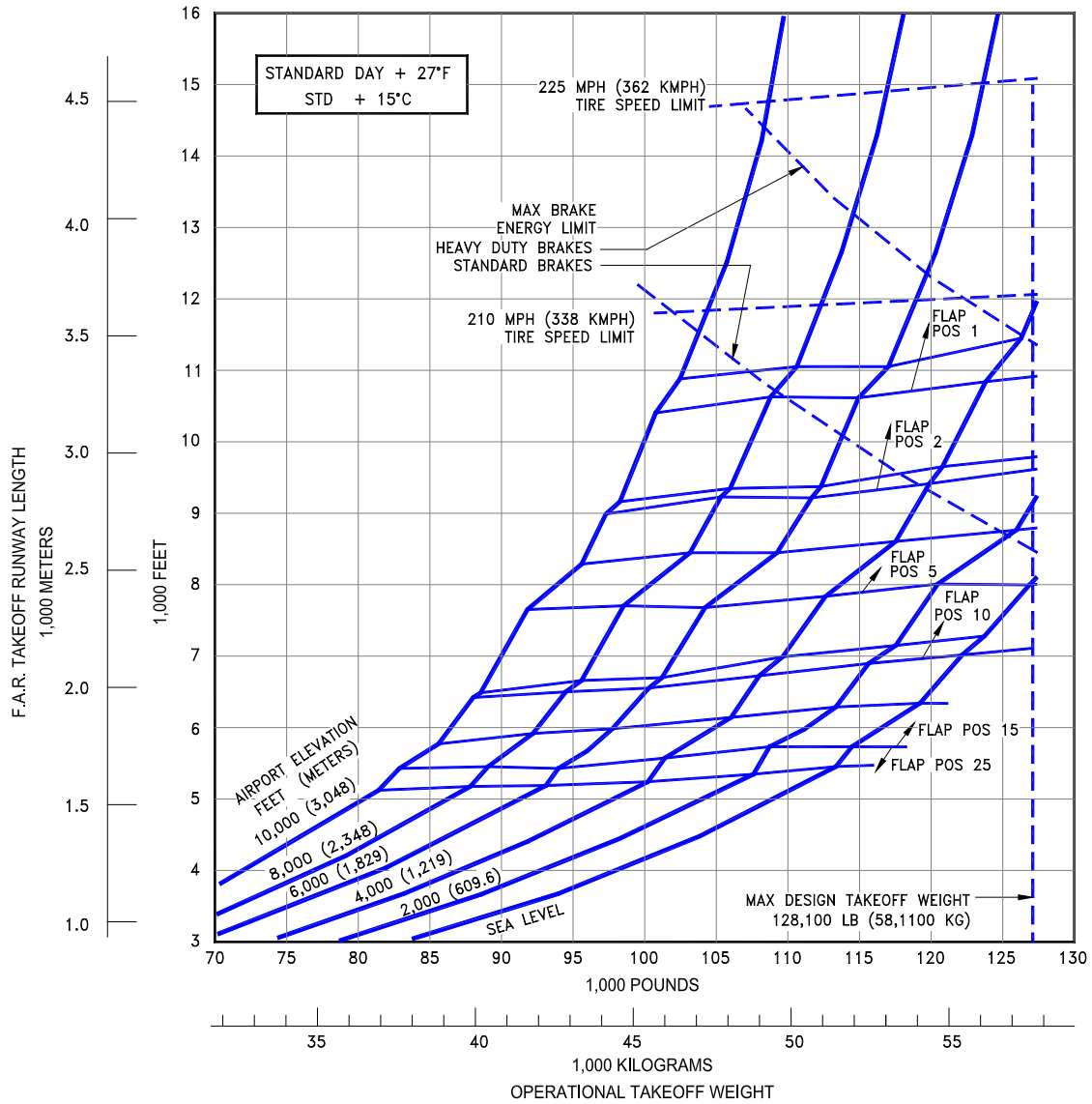

D6-58325-6

3.3.11 F.A.R. Takeoff Runway Length Requirements - Standard Day: Model 737-300 (CFM56-3B1 Engines at 20,000 LB SLST)

NOTES:

- * NO ENGINE AIRBLEED FOR AIR CONDITIONING
- * ZERO WIND, ZERO RUNWAY GRADIENT
- * CONSULT USING AIRLINE FOR SPECIFIC OPERATING PROCEDURE PRIOR TO FACILITY DESIGN
- * CFM 56-3B1 ENGINES RATED AT 20,000 LB SLST

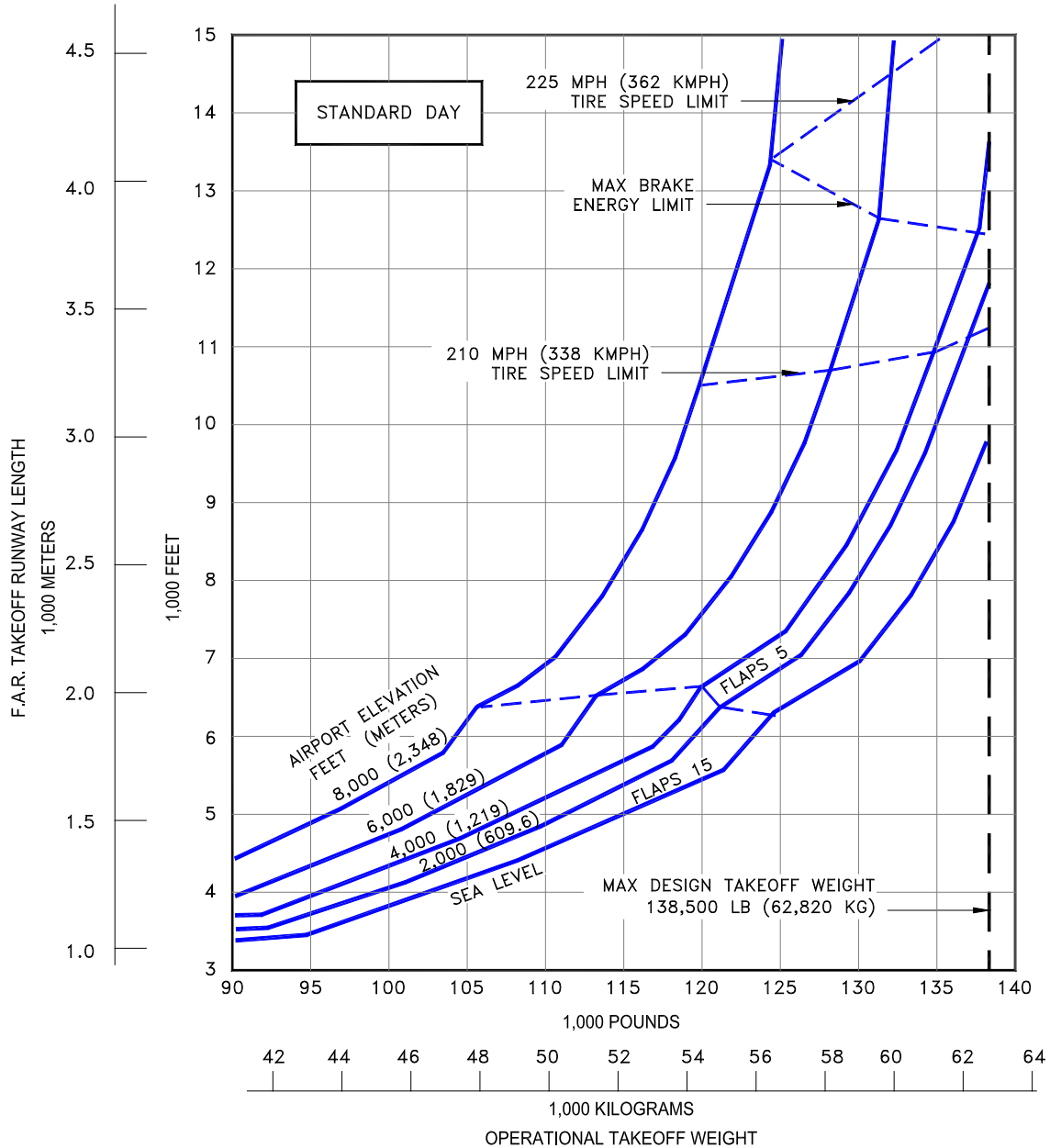

D6-58325-6

3.3.12 F.A.R. Takeoff Runway Length Requirements - Standard Day + 27°F (STD + 15°C): Model 737-300 (CFM56-3B1 Engines at 20,000 LB SLST)

NOTES:

- * NO ENGINE AIRBLEED FOR AIR CONDITIONING
- * ZERO WIND, ZERO RUNWAY GRADIENT
- * CONSULT USING AIRLINE FOR SPECIFIC OPERATING PROCEDURE PRIOR TO FACILITY DESIGN
- * CFM 56-3B1 ENGINES RATED AT 20,000 LB SLST

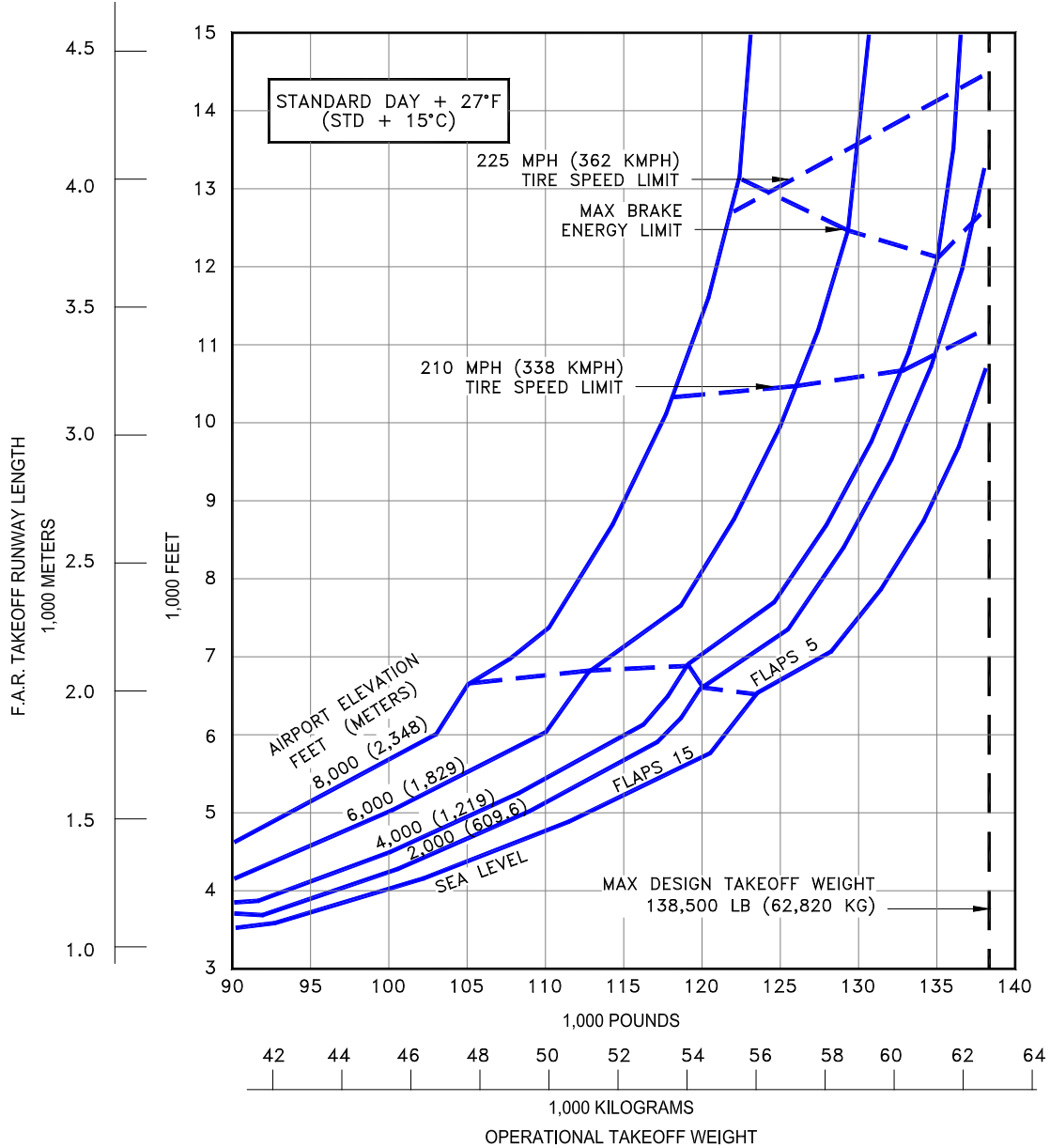

3.3.13 F.A.R. Takeoff Runway Length Requirements - Standard Day: Model 737-300 (CFM56-3B-2 Engines at 22,000 LB SLST)

NOTES:

- * NO ENGINE AIRBLEED FOR AIR CONDITIONING
- * ZERO WIND, ZERO RUNWAY GRADIENT
- * CONSULT USING AIRLINE FOR SPECIFIC OPERATING PROCEDURE PRIOR TO FACILITY DESIGN
- * CFM 56-3B2 ENGINES RATED AT 22,000 LB SLST

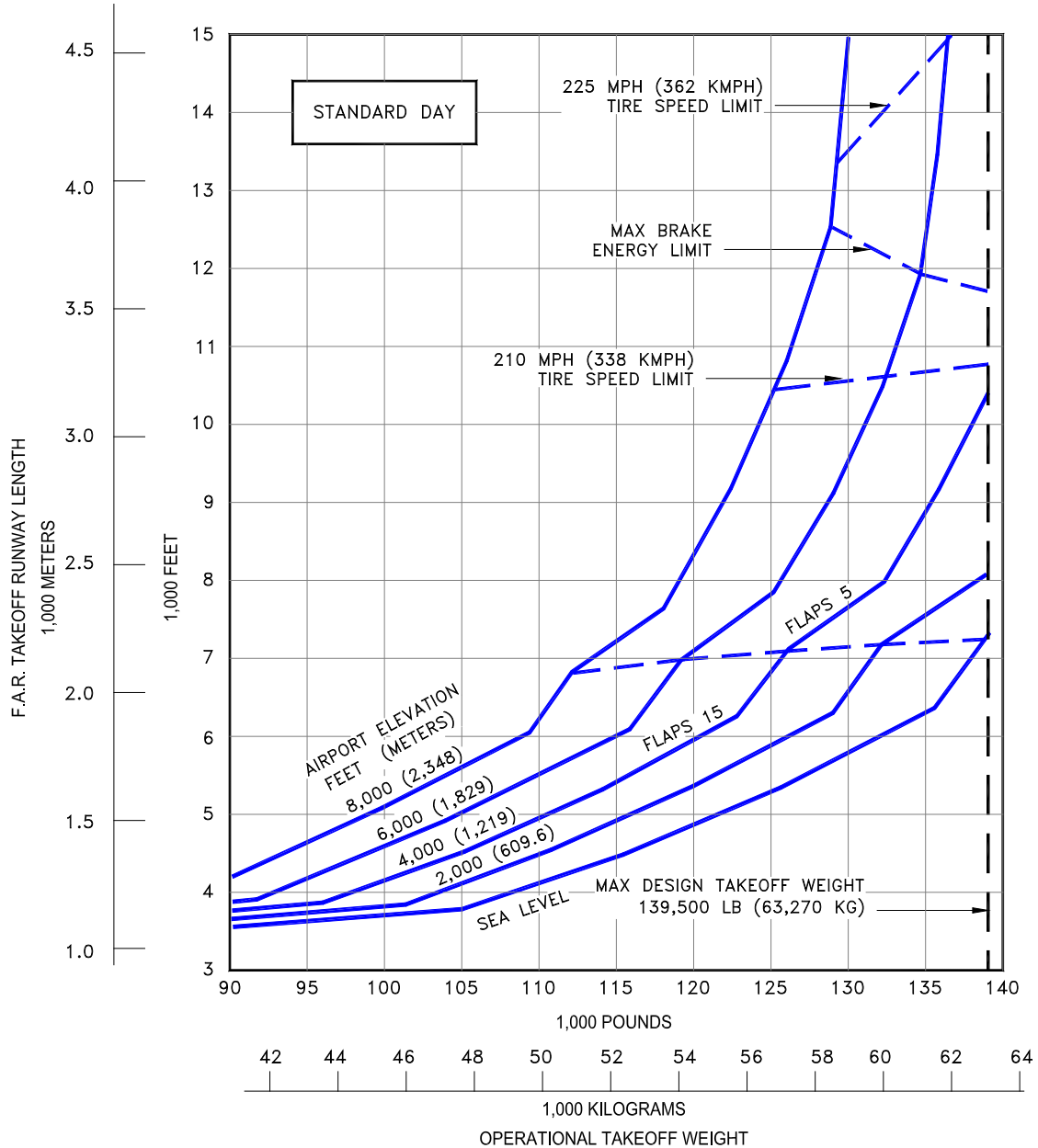

D6-58325-6

3.3.14 F.A.R. Takeoff Runway Length Requirements - Standard Day + 27°F (STD + 15°C): Model 737-300 (CFM56-3B-2 Engines at 22,000 LB SLST)

NOTES:

- * NO ENGINE AIRBLEED FOR AIR CONDITIONING
- * ZERO WIND, ZERO RUNWAY GRADIENT
- * CONSULT USING AIRLINE FOR SPECIFIC OPERATING PROCEDURE PRIOR TO FACILITY DESIGN
- * CFM 56-3B2 ENGINES RATED AT 22,000 LB SLST

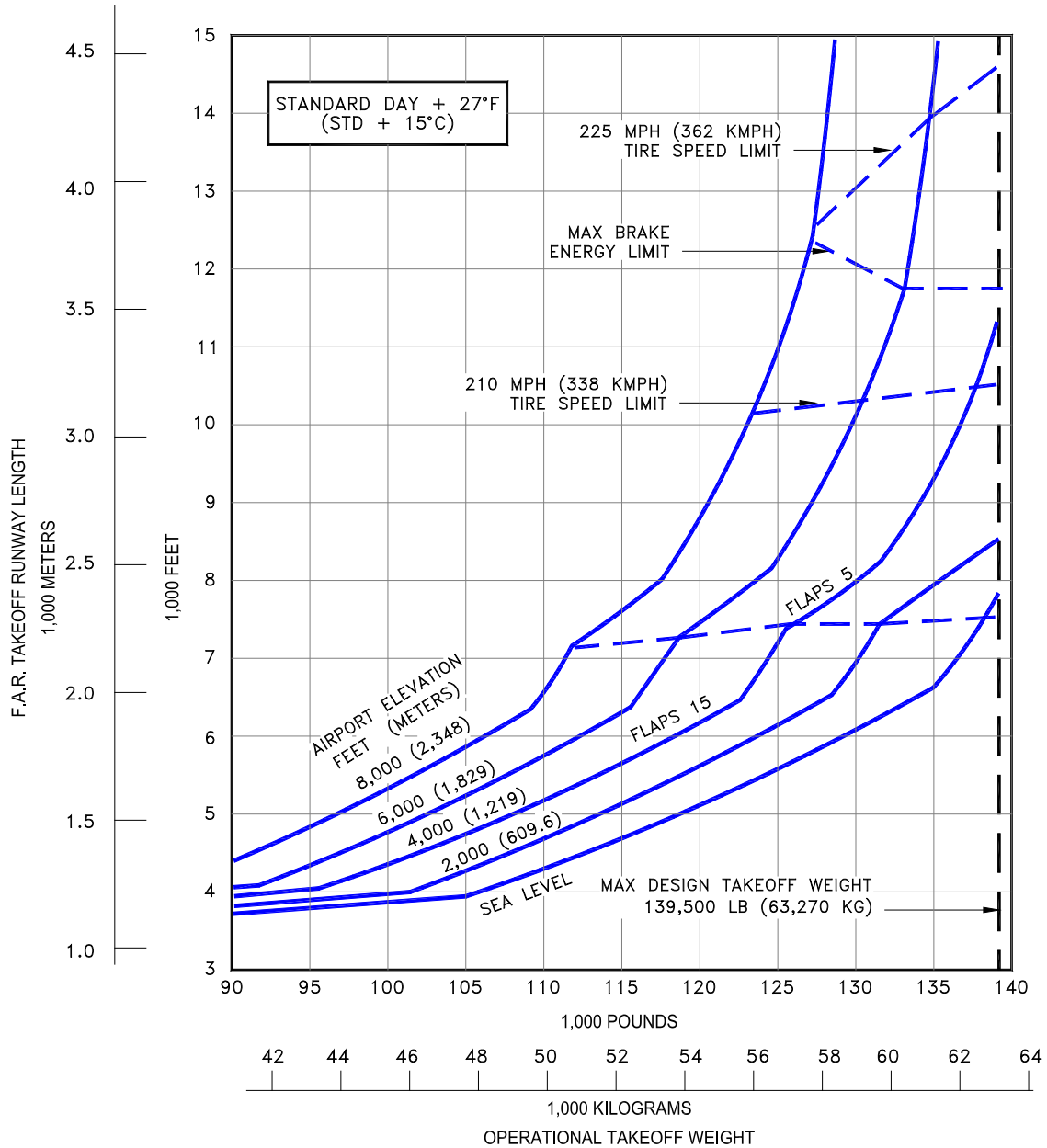

3.3.15 F.A.R. Takeoff Runway Length Requirements - Standard Day: Model 737-400 (CFM56-3B-2 Engines at 22,000 LB SLST)

NOTES:

- * NO ENGINE AIRBLEED FOR AIR CONDITIONING
- * ZERO WIND, ZERO RUNWAY GRADIENT
- * CONSULT USING AIRLINE FOR SPECIFIC OPERATING PROCEDURE PRIOR TO FACILITY DESIGN
- * CFM 56-3B2 ENGINES RATED AT 22,000 LB SLST

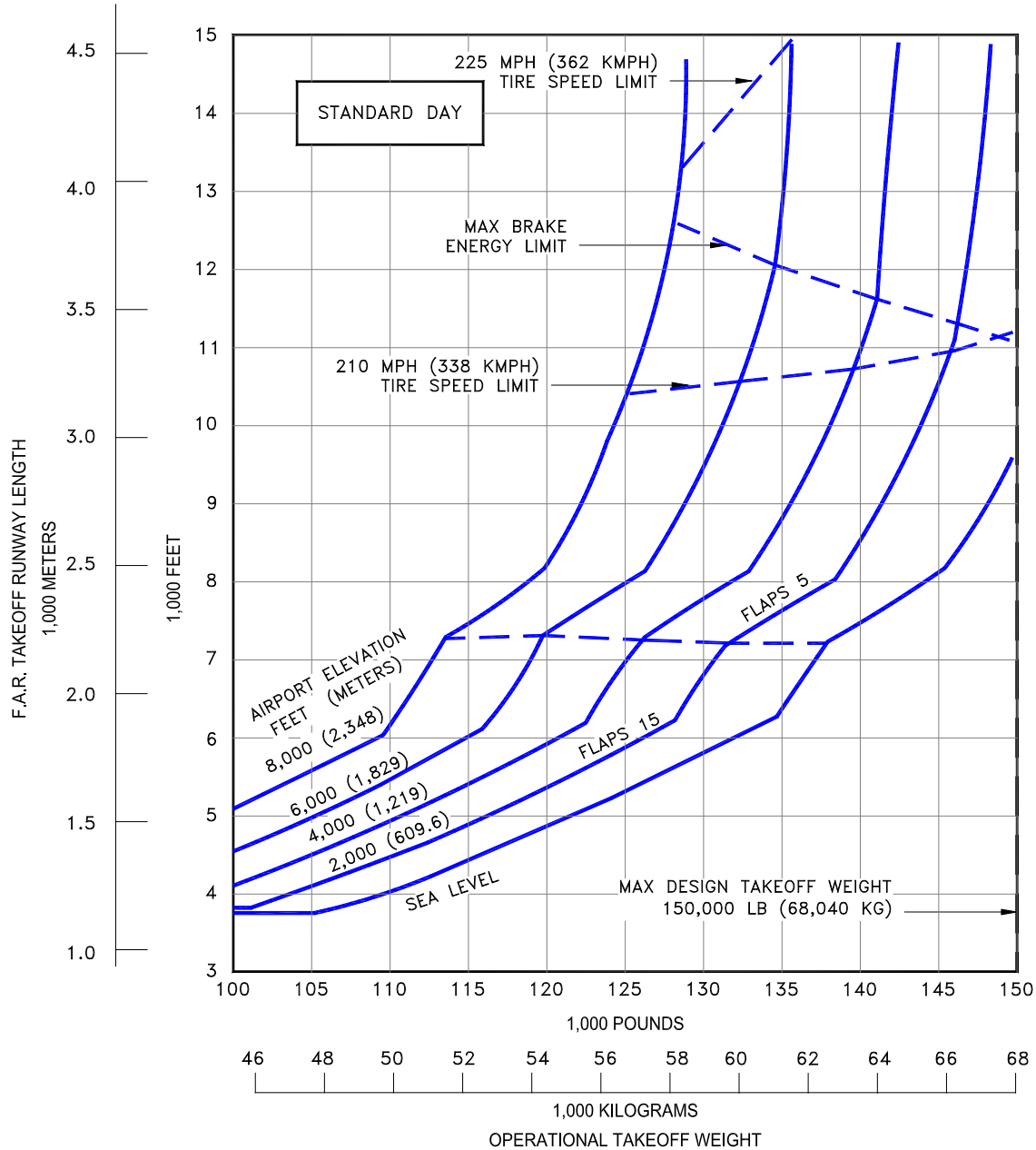

3.3.16 F.A.R. Takeoff Runway Length Requirements - Standard Day + 27°F (STD + 15°C): Model 737-400 (CFM56-3B-2 Engines at 22,000 LB SLST)

NOTES:

- * NO ENGINE AIRBLEED FOR AIR CONDITIONING
- * ZERO WIND, ZERO RUNWAY GRADIENT
- * CONSULT USING AIRLINE FOR SPECIFIC OPERATING PROCEDURE PRIOR TO FACILITY DESIGN
- * CFM 56-3B2 ENGINES RATED AT 22,000 LB SLST

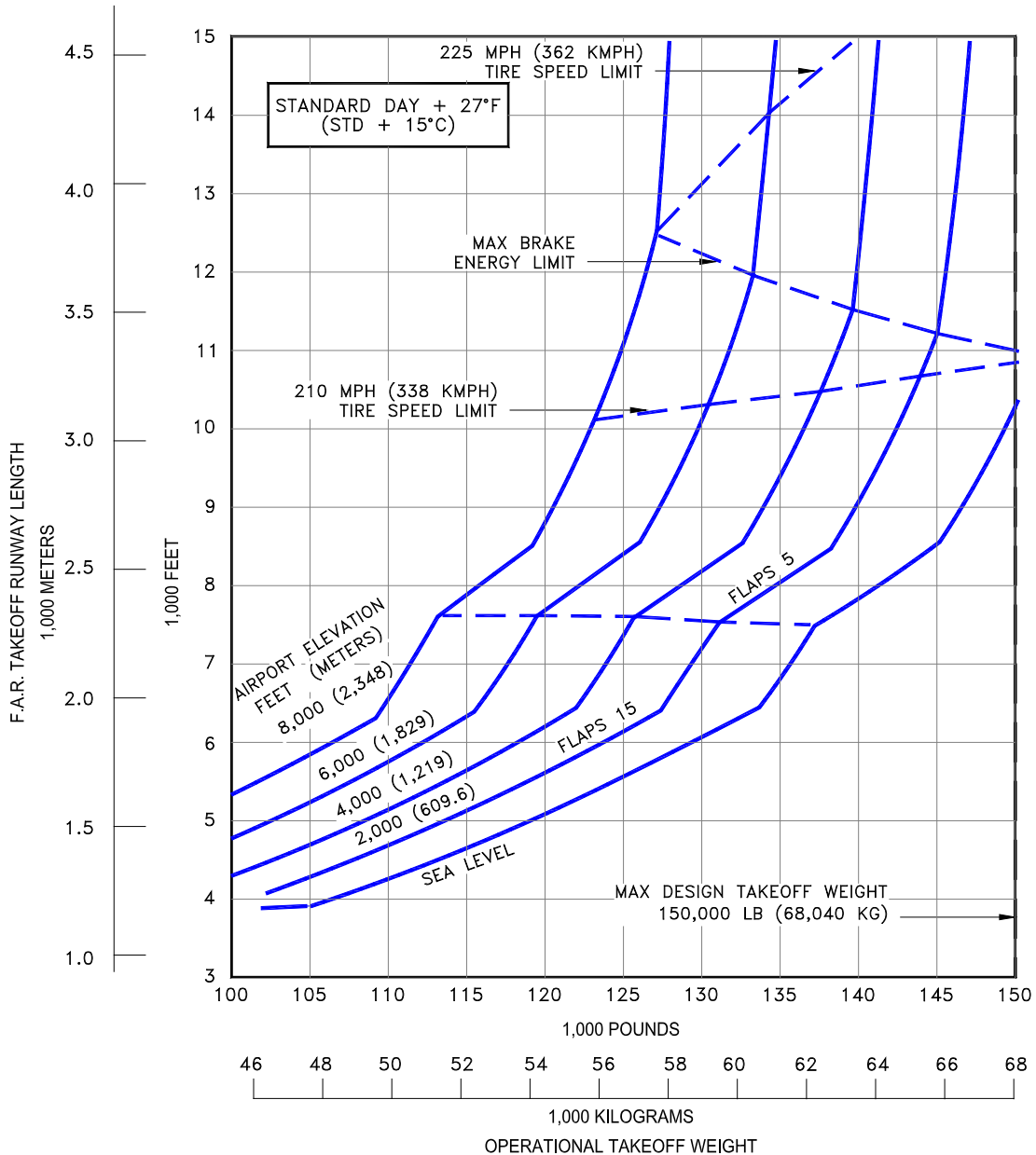

3.3.17 F.A.R. Takeoff Runway Length Requirements - Standard Day: Model 737-400 (CFM56-3C1 Engines at 23,500 LB SLST)

NOTES:

- * NO ENGINE AIRBLEED FOR AIR CONDITIONING
- * ZERO WIND, ZERO RUNWAY GRADIENT
- * CONSULT USING AIRLINE FOR SPECIFIC OPERATING PROCEDURE PRIOR TO FACILITY DESIGN
- * CFM 56-3C1 ENGINES RATED AT 23,500 LB SLST

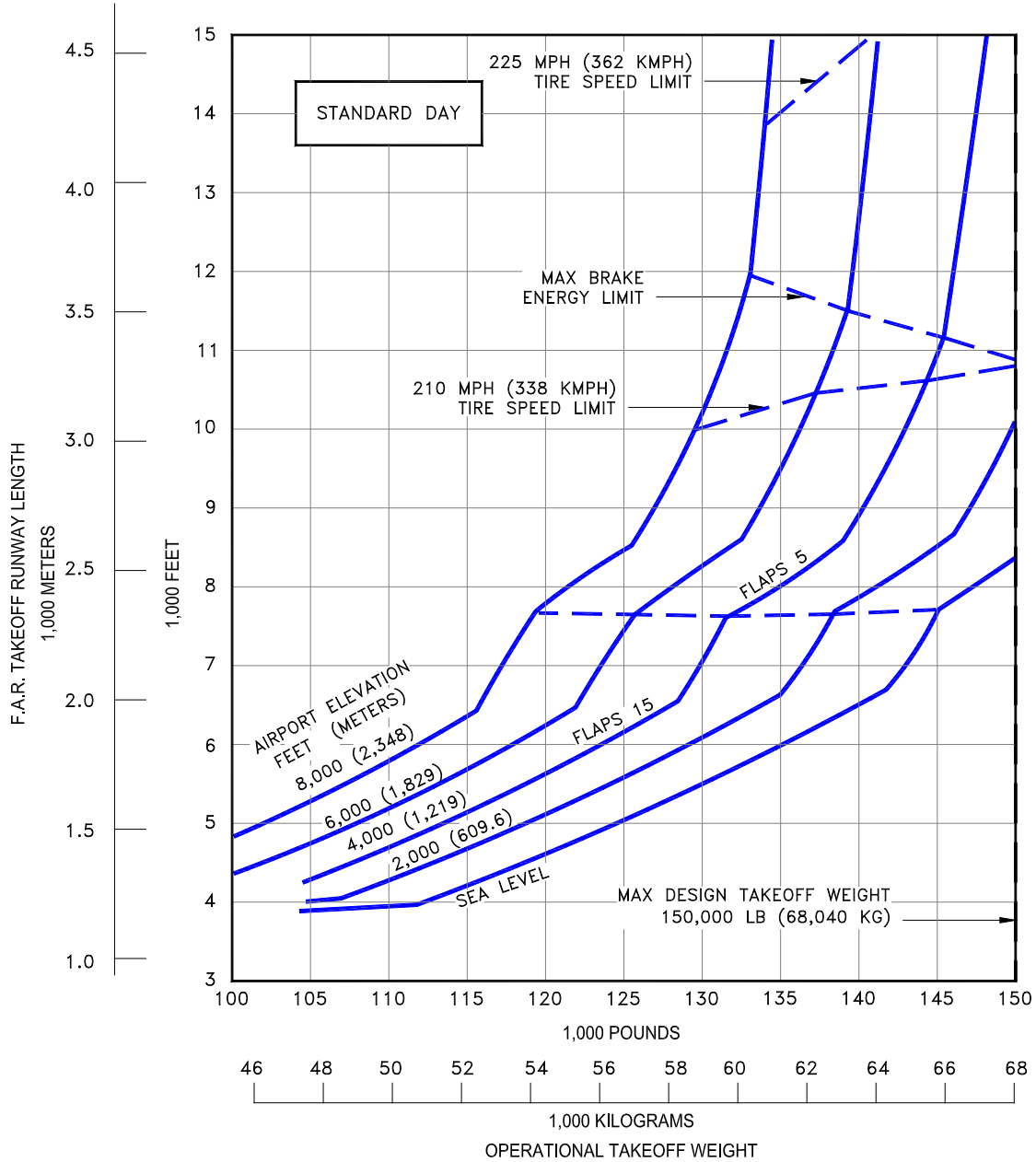

3.3.18 F.A.R. Takeoff Runway Length Requirements - Standard Day + 27°F (STD + 15°C): Model 737-400 (CFM56-3C1 Engines at 23,500 LB SLST)

NOTES:

- * NO ENGINE AIRBLEED FOR AIR CONDITIONING
- * ZERO WIND, ZERO RUNWAY GRADIENT
- * CONSULT USING AIRLINE FOR SPECIFIC OPERATING PROCEDURE PRIOR TO FACILITY DESIGN
- * CFM 56-3C1 ENGINES RATED AT 23,500 LB SLST

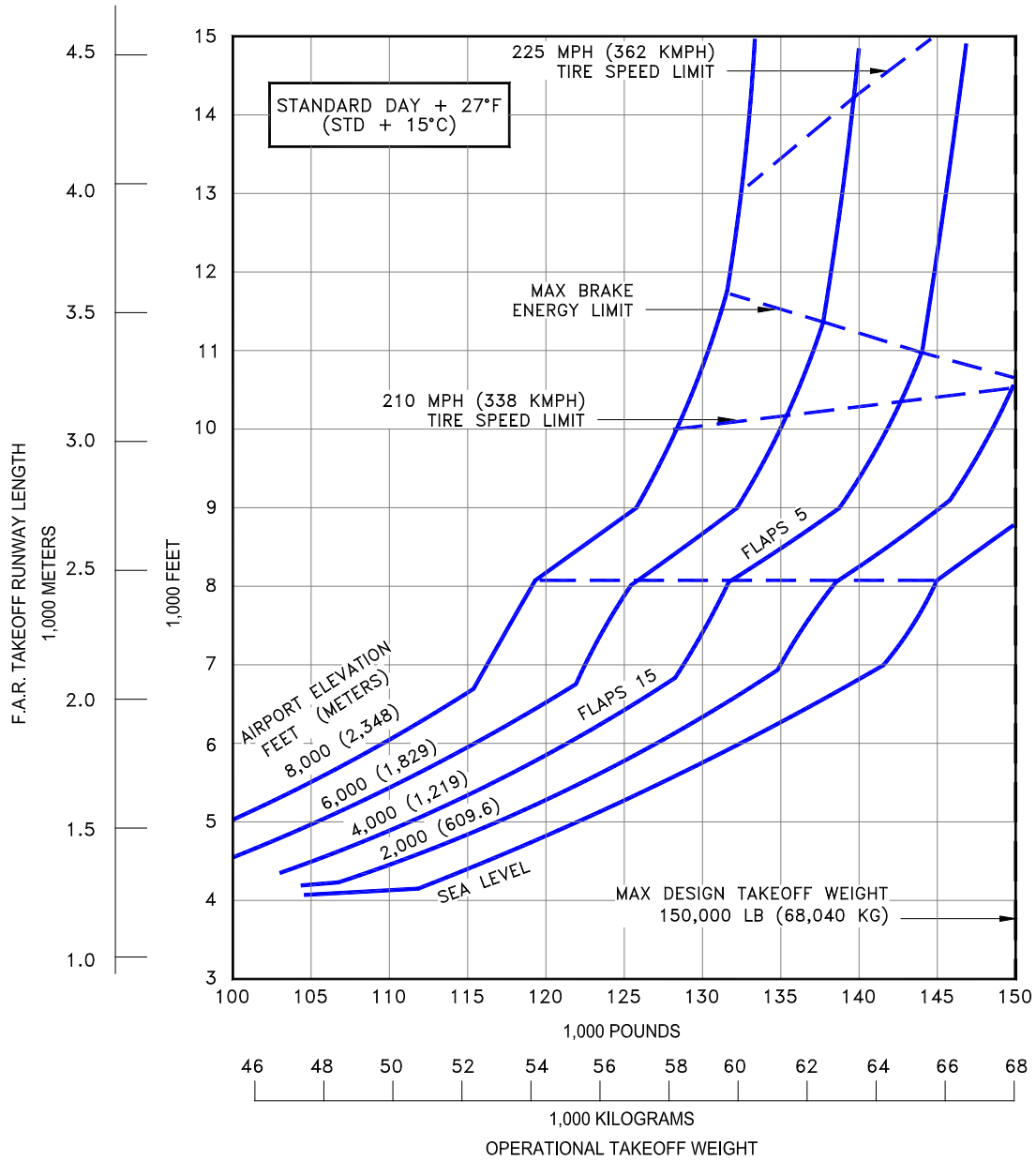

D6-58325-6

3.3.19 F.A.R. Takeoff Runway Length Requirements - Standard Day: Model 737-500 (CFM56-3B-1 Engines at 20,000 LB SLST)

NOTES:

- * NO ENGINE AIRBLEED FOR AIR CONDITIONING
- * ZERO WIND, ZERO RUNWAY GRADIENT
- * CONSULT USING AIRLINE FOR SPECIFIC OPERATING PROCEDURE PRIOR TO FACILITY DESIGN
- * CFM 56-3B1 ENGINES RATED AT 20,000 LB SLST

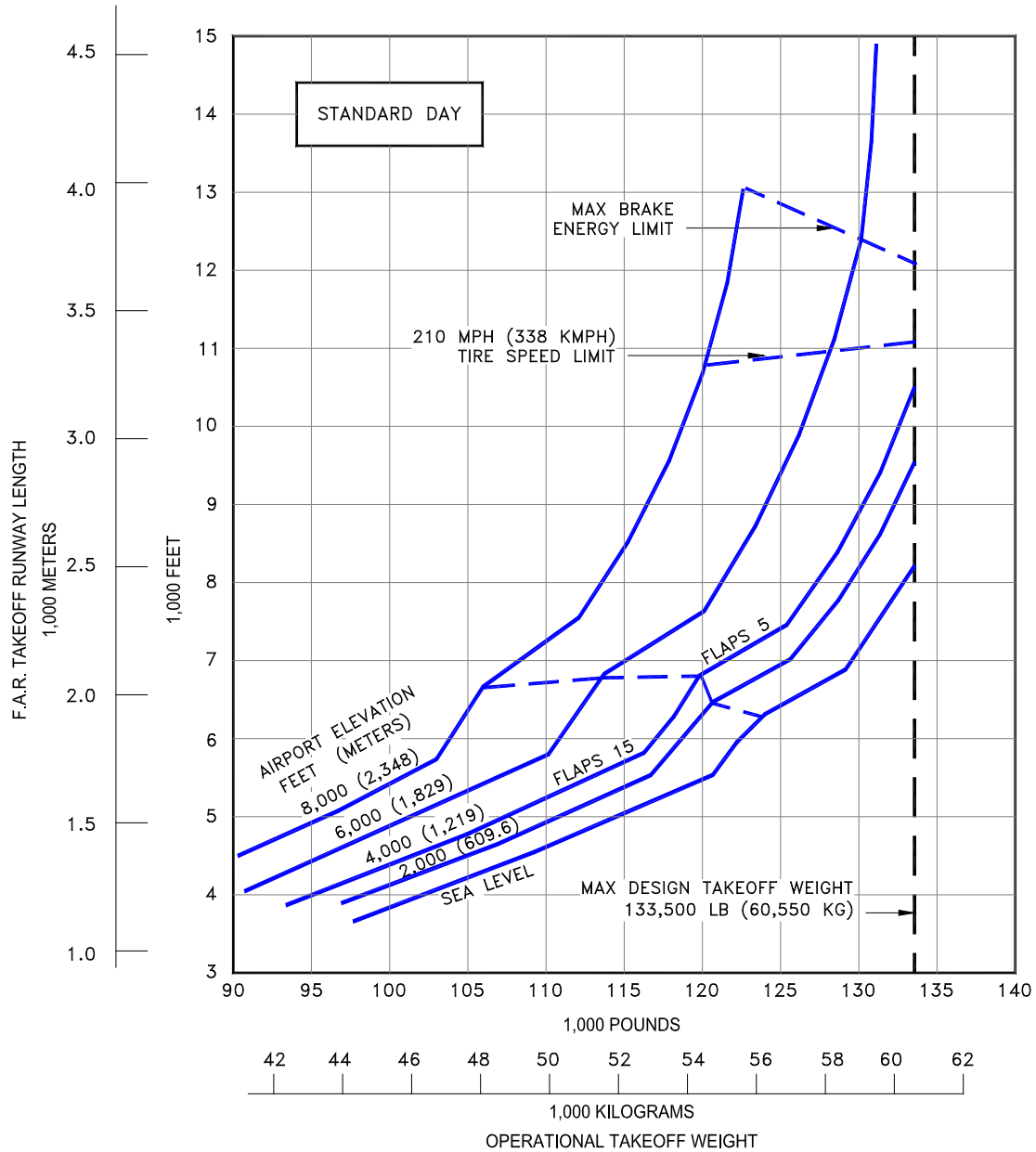

3.3.20 F.A.R. Takeoff Runway Length Requirements - Standard Day + 27°F (STD + 15°C): Model 737-500 (CFM56-3B-1 Engines at 20,000 LB SLST)

NOTES:

- * NO ENGINE AIRBLEED FOR AIR CONDITIONING
- * ZERO WIND, ZERO RUNWAY GRADIENT
- * CONSULT USING AIRLINE FOR SPECIFIC OPERATING PROCEDURE PRIOR TO FACILITY DESIGN
- * CFM 56-3B1 ENGINES RATED AT 20,000 LB SLST

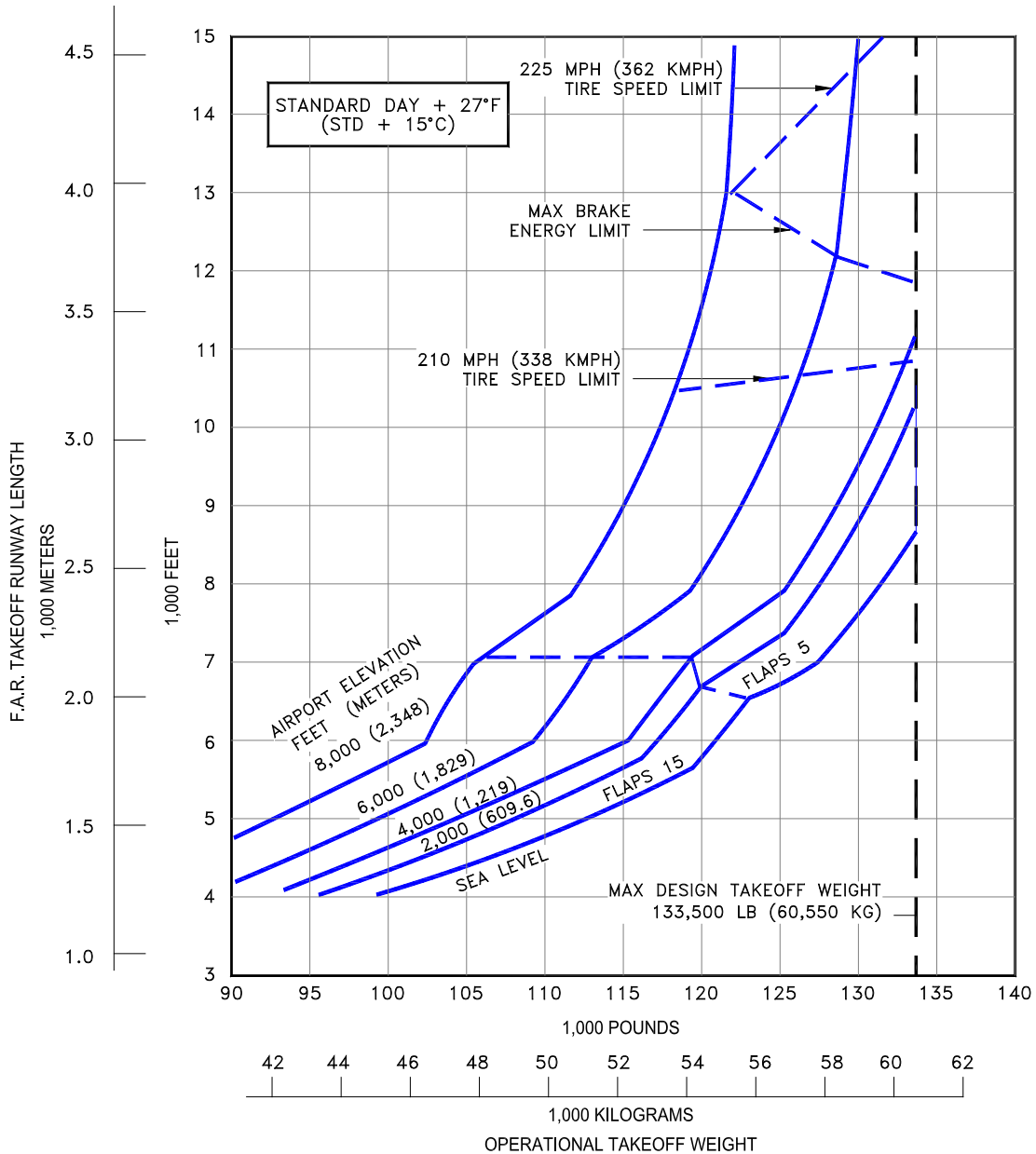

D6-58325-6

3.3.21 F.A.R. Takeoff Runway Length Requirements - Standard Day: Model 737-500 (CFM56-3B-1 Engines at 18,500 LB SLST)

NOTES:

- * NO ENGINE AIRBLEED FOR AIR CONDITIONING
- * ZERO WIND, ZERO RUNWAY GRADIENT
- * CONSULT USING AIRLINE FOR SPECIFIC OPERATING PROCEDURE PRIOR TO FACILITY DESIGN
- * CFM 56-3B1 ENGINES RATED AT 18,500 LB SLST

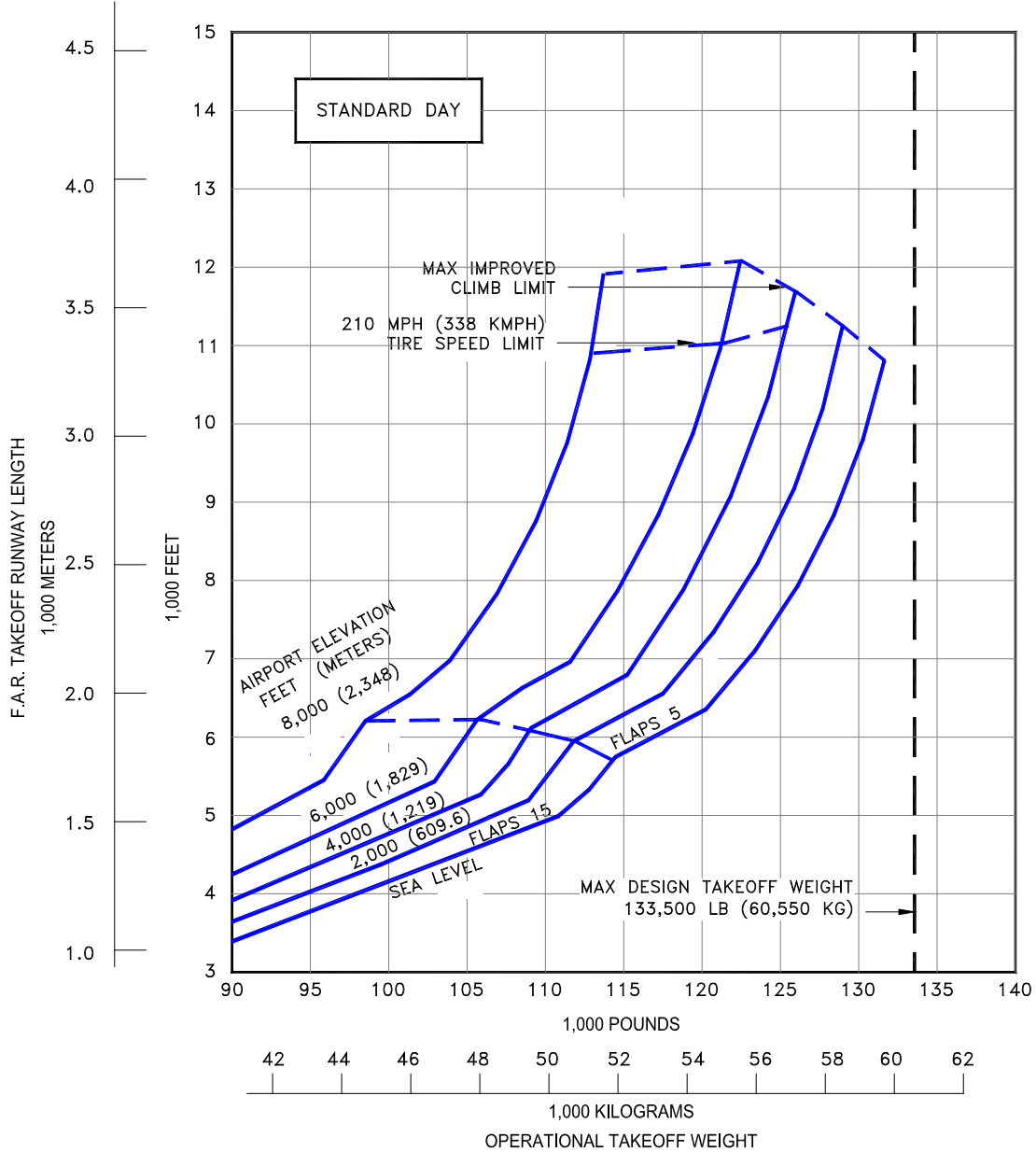

3.3.22 F.A.R. Takeoff Runway Length Requirements - Standard Day + 27°F (STD + 15°C): Model 737-500 (CFM56-3B-1 Engines at 18,500 LB SLST)

NOTES:

- * NO ENGINE AIRBLEED FOR AIR CONDITIONING
- * ZERO WIND, ZERO RUNWAY GRADIENT
- * CONSULT USING AIRLINE FOR SPECIFIC OPERATING PROCEDURE PRIOR TO FACILITY DESIGN
- * CFM 56-3B1 ENGINES RATED AT 18,500 LB SLST

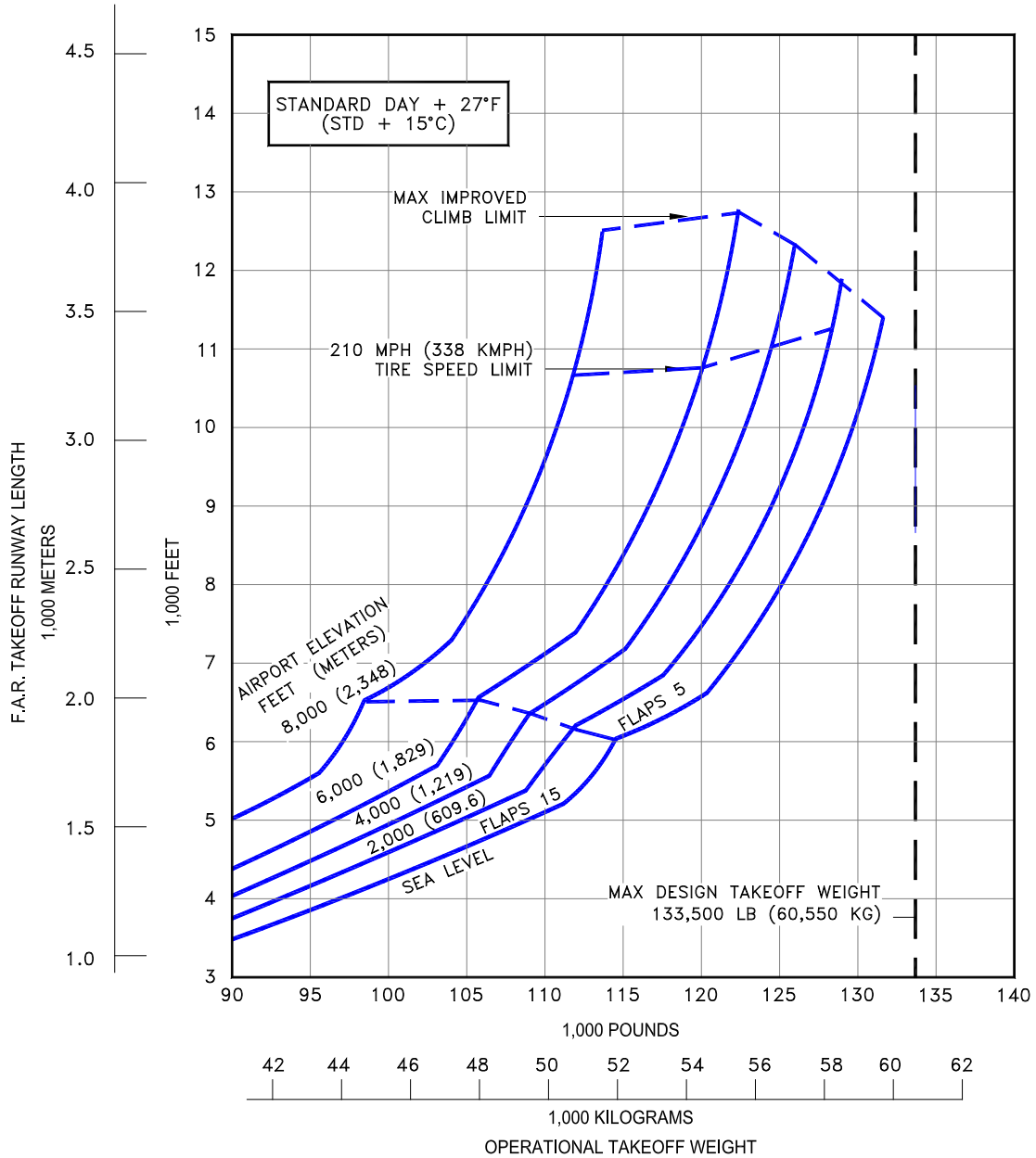

3.4 F.A.R. AND J.A.R. LANDING RUNWAY LENGTH REQUIREMENTS

3.4.1 F.A.R. Landing Runway Length Requirements - Flaps 40: Model 737-100

NOTES:

- * $V_{APP} = 1.3V_S$
- * ZERO WIND
- * FLAP POSITION 40
- * AUTOMATIC SPEED BRAKES
- * CONSULT WITH USING AIRLINE FOR SPECIFIC PROCEDURE PRIOR TO FACILITY DESIGN

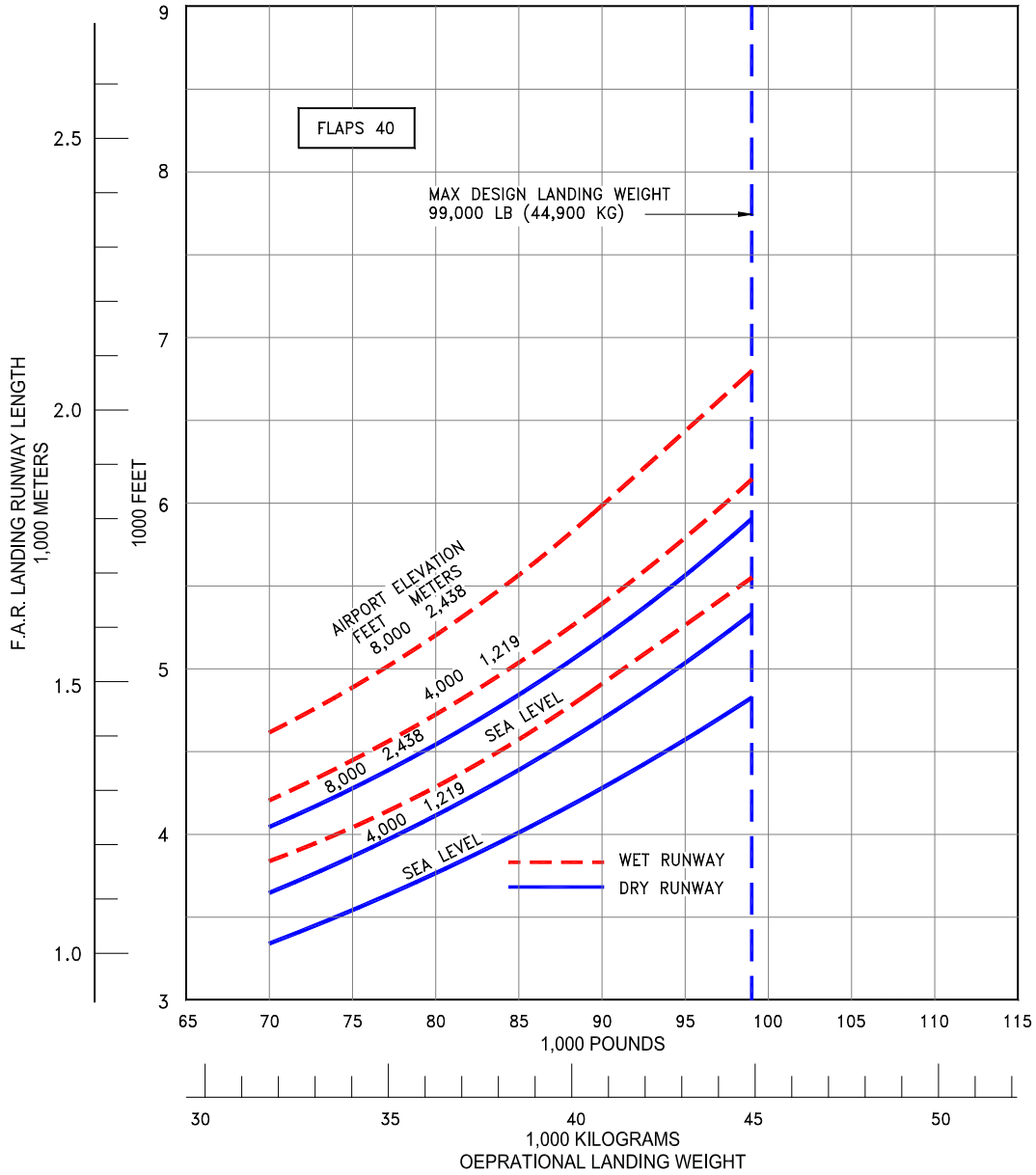

3.4.2 F.A.R. Landing Runway Length Requirements - Flaps 30: Model 737-100

NOTES:

- * $V_{APP} = 1.3V_S$
- * ZERO WIND
- * FLAP POSITION 30
- * AUTOMATIC SPEED BRAKES
- * CONSULT WITH USING AIRLINE FOR SPECIFIC PROCEDURE PRIOR TO FACILITY DESIGN

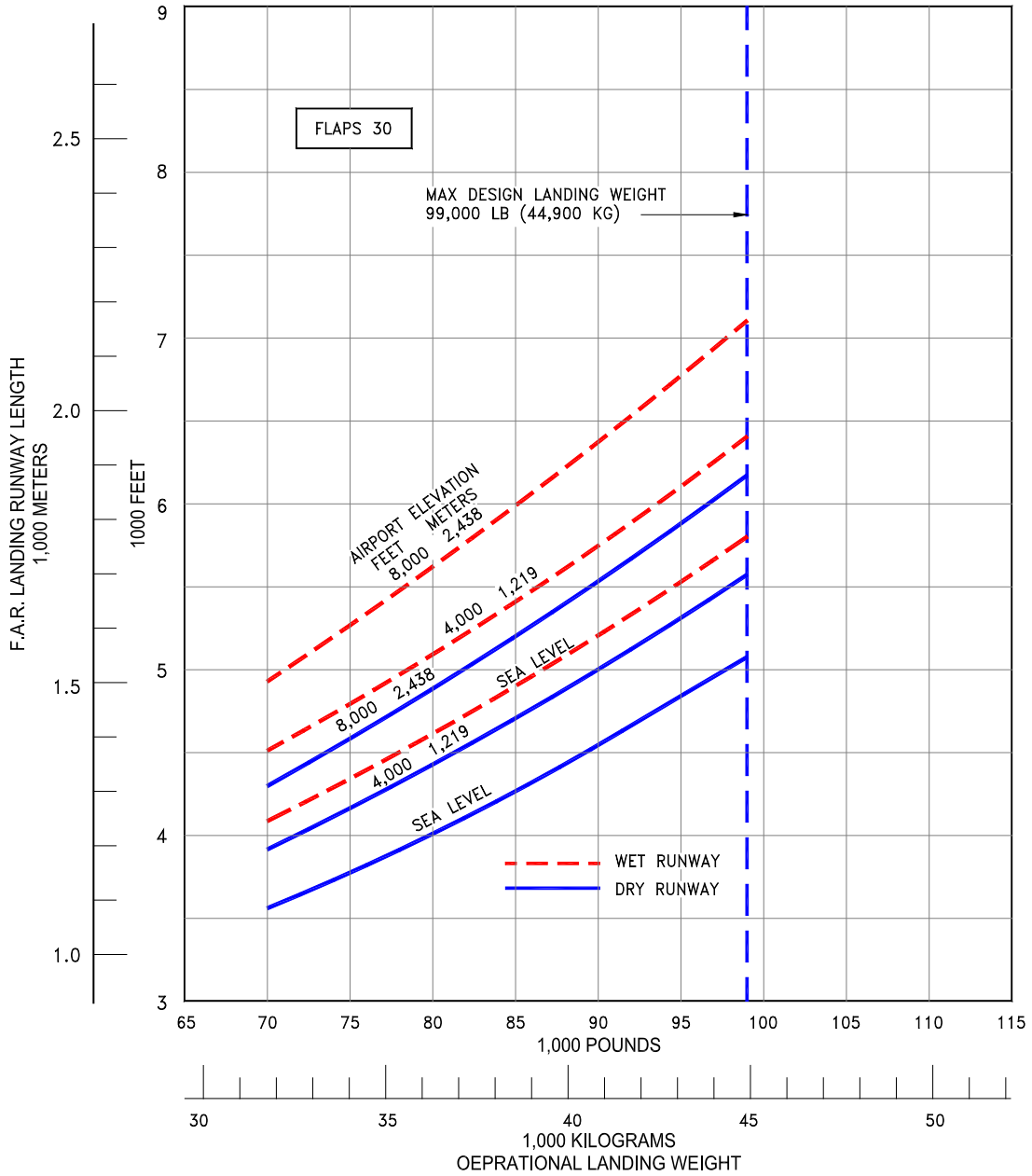

D6-58325-6

3.4.3 F.A.R. Landing Runway Length Requirements - Flaps 25: Model 737-100

NOTES:

- * $V_{APP} = 1.3V_S$
- * ZERO WIND
- * FLAP POSITION 25
- * AUTOMATIC SPEED BRAKES
- * CONSULT WITH USING AIRLINE FOR SPECIFIC PROCEDURE PRIOR TO FACILITY DESIGN

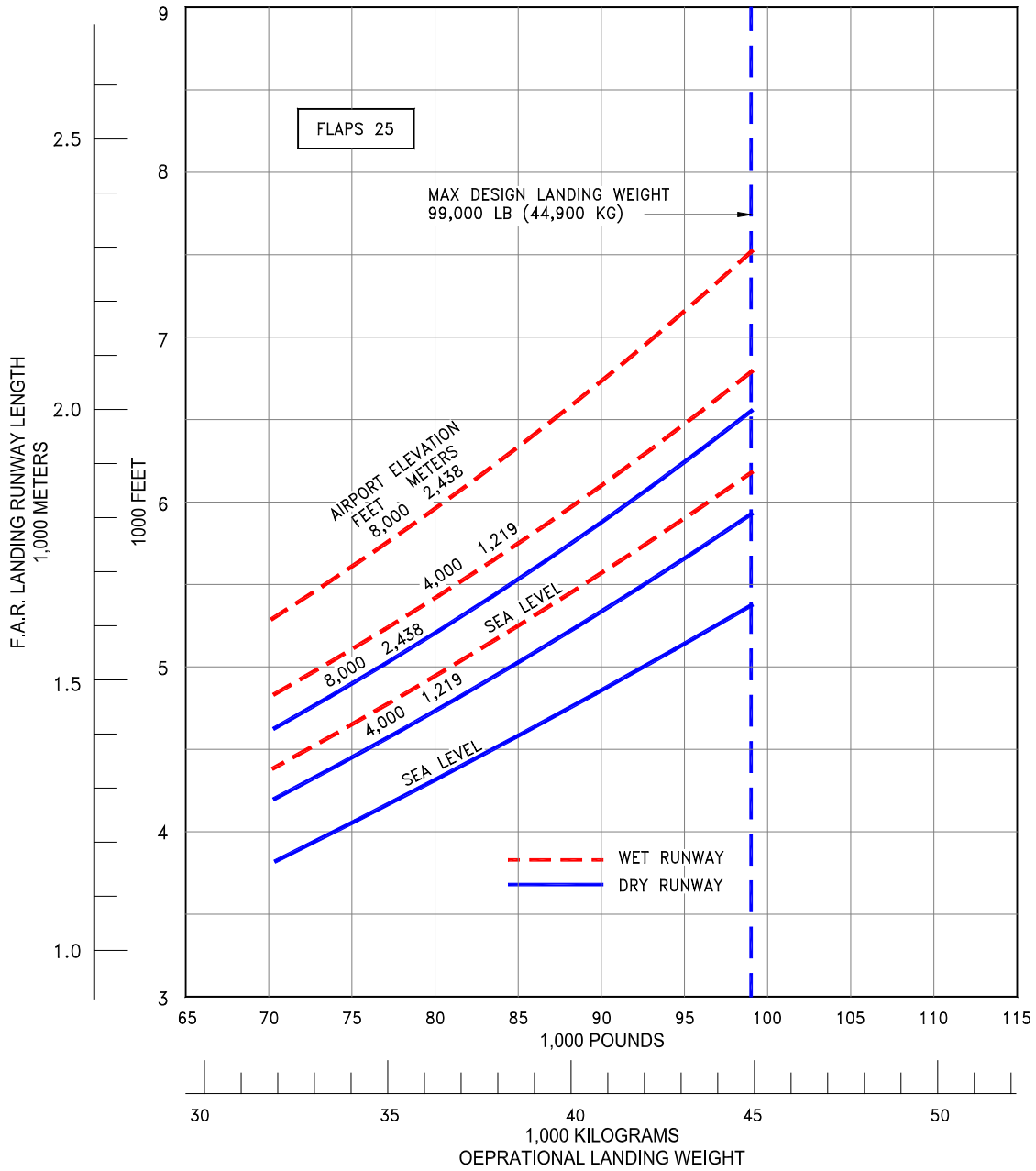

D6-58325-6

3.4.4 F.A.R. Landing Runway Length Requirements - Flaps 40: Model 737-200, -200C

NOTES:

- * $V_{APP} = 1.3V_S$
- * ZERO WIND
- * FLAP POSITION 40
- * AUTOMATIC SPEED BRAKES
- * CONSULT WITH USING AIRLINE FOR SPECIFIC PROCEDURE PRIOR TO FACILITY DESIGN

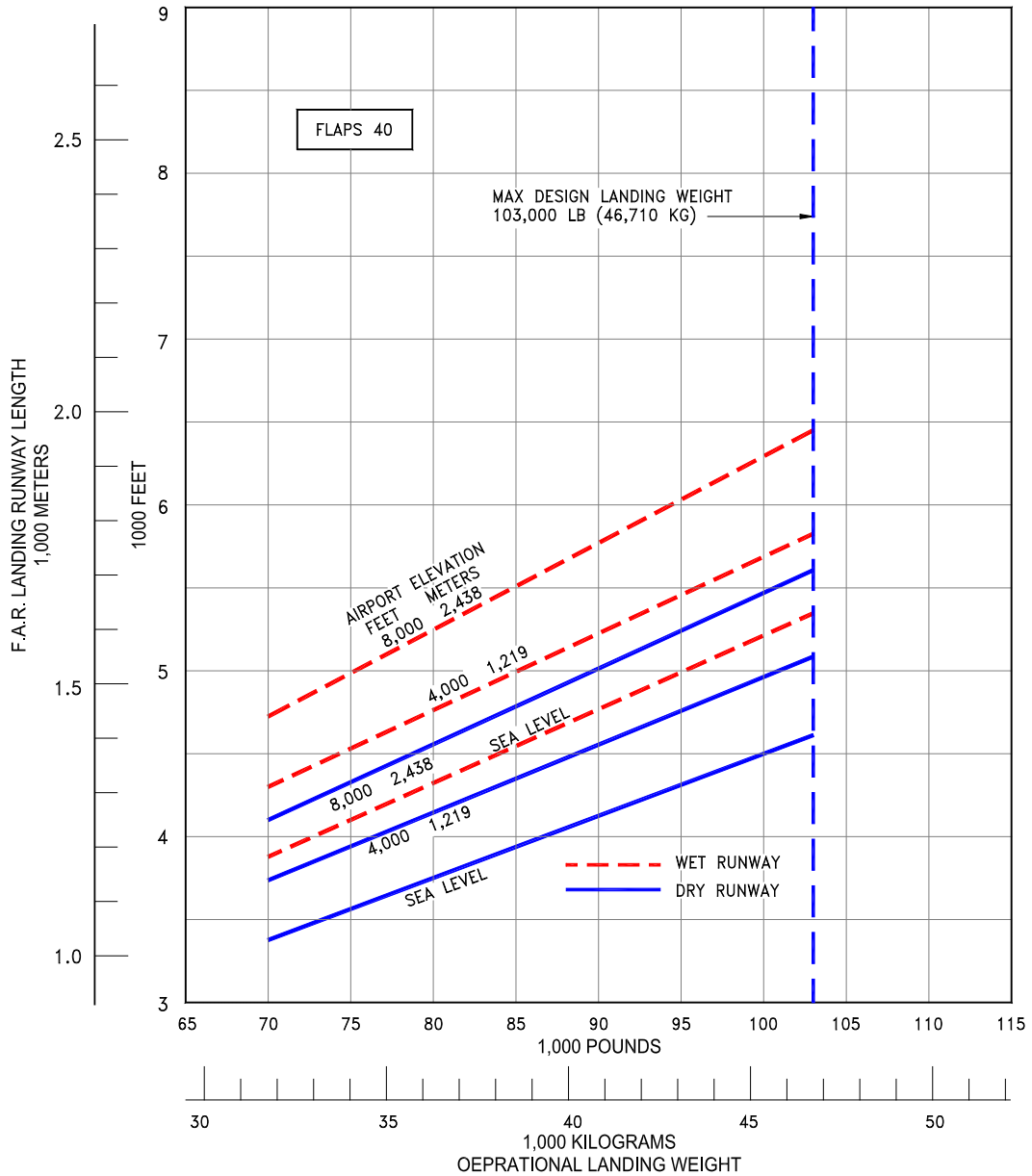

3.4.5 F.A.R. Landing Runway Length Requirements - Flaps 30: Model 737-200, -200C

- NOTES:
- * $V_{APP} = 1.3V_S$
 - * ZERO WIND
 - * FLAP POSITION 30
 - * AUTOMATIC SPEED BRAKES
 - * CONSULT WITH USING AIRLINE FOR SPECIFIC PROCEDURE PRIOR TO FACILITY DESIGN

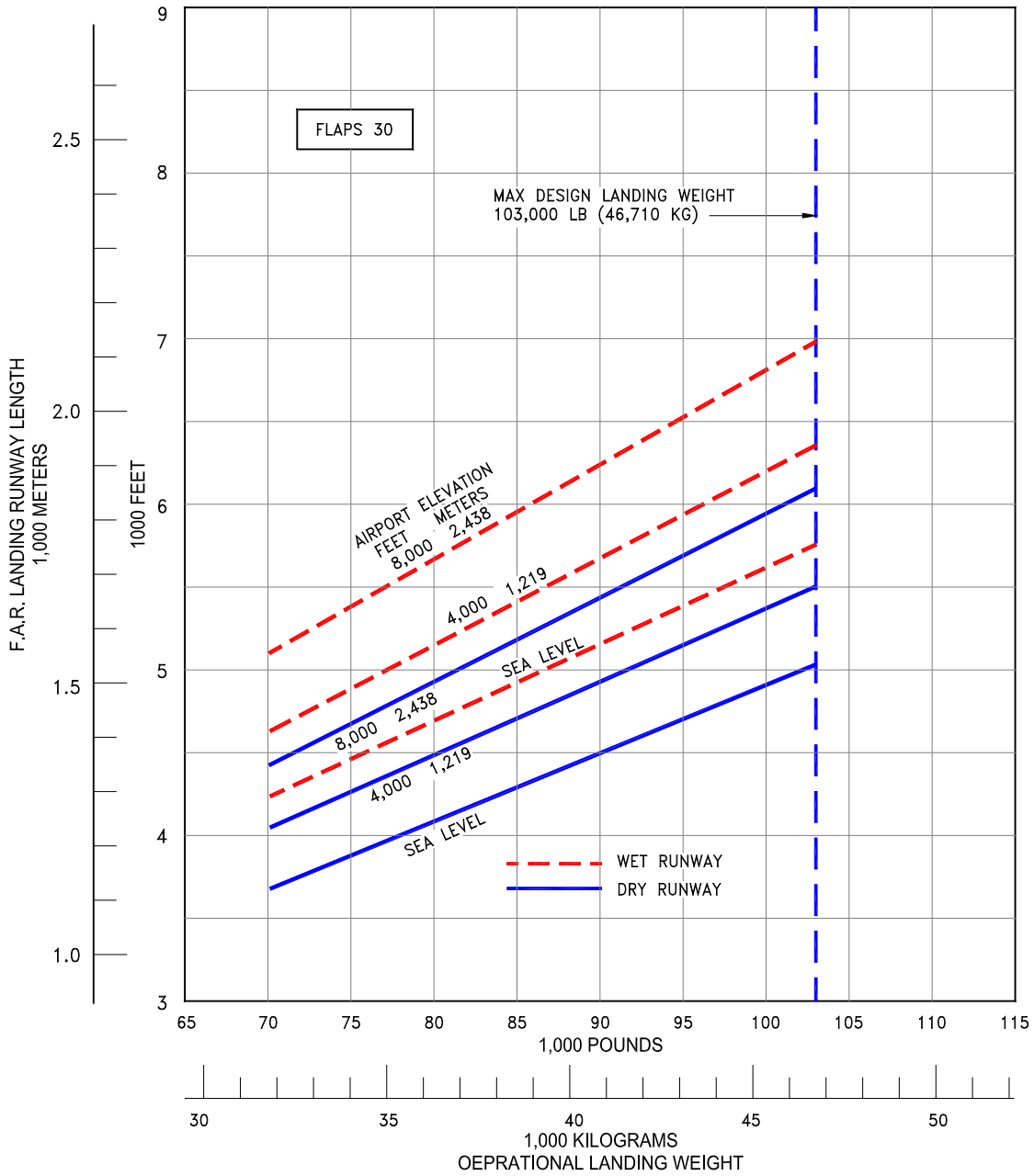

3.4.6 F.A.R. Landing Runway Length Requirements - Flaps 25: Model 737-200, -200C

NOTES:

- * $V_{APP} = 1.3V_S$
- * ZERO WIND
- * FLAP POSITION 25
- * AUTOMATIC SPEED BRAKES
- * CONSULT WITH USING AIRLINE FOR SPECIFIC PROCEDURE PRIOR TO FACILITY DESIGN

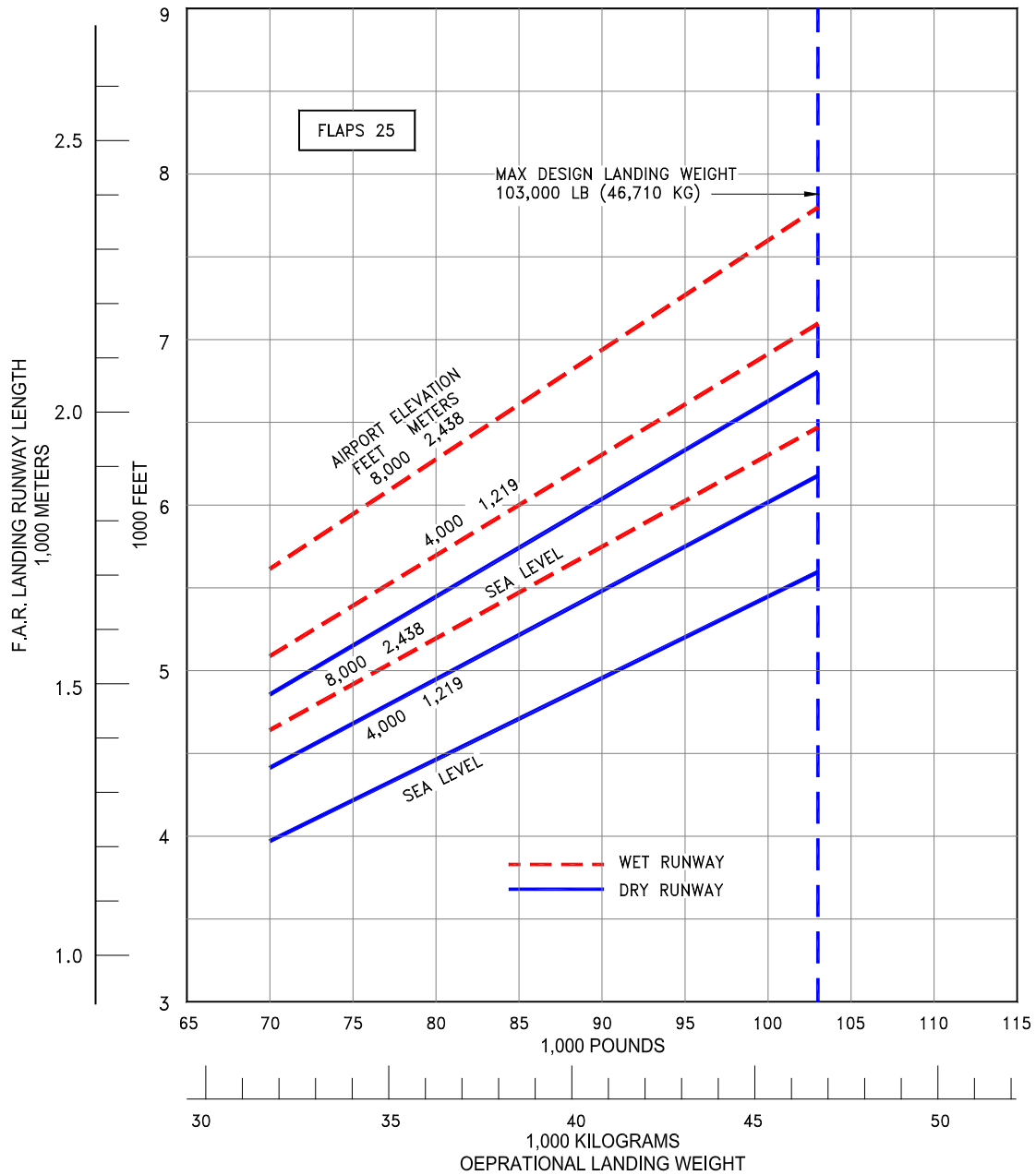

D6-58325-6

3.4.7 F.A.R. Landing Runway Length Requirements - Flaps 40: Model 737-200ADV, -200C

NOTES:

- * $V_{APP} = 1.3V_S$
- * ZERO WIND
- * FLAP POSITION 40
- * AUTOMATIC SPEED BRAKES
- * CONSULT WITH USING AIRLINE FOR SPECIFIC PROCEDURE PRIOR TO FACILITY DESIGN

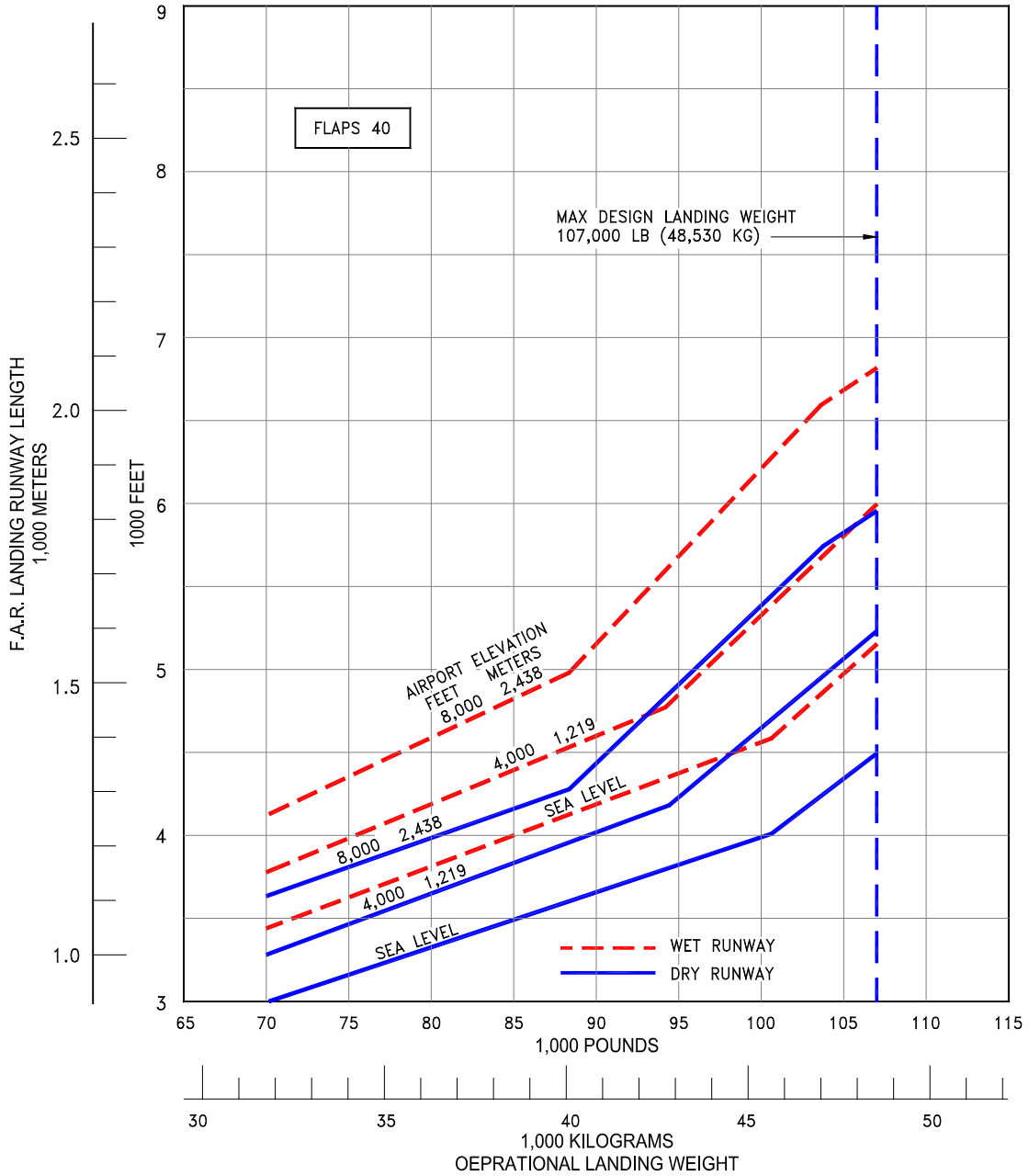

3.4.8 F.A.R. Landing Runway Length Requirements - Flaps 30: Model 737-200ADV, -200C

NOTES:

- * $V_{APP} = 1.3V_S$
- * ZERO WIND
- * FLAP POSITION 30
- * AUTOMATIC SPEED BRAKES
- * CONSULT WITH USING AIRLINE FOR SPECIFIC PROCEDURE PRIOR TO FACILITY DESIGN

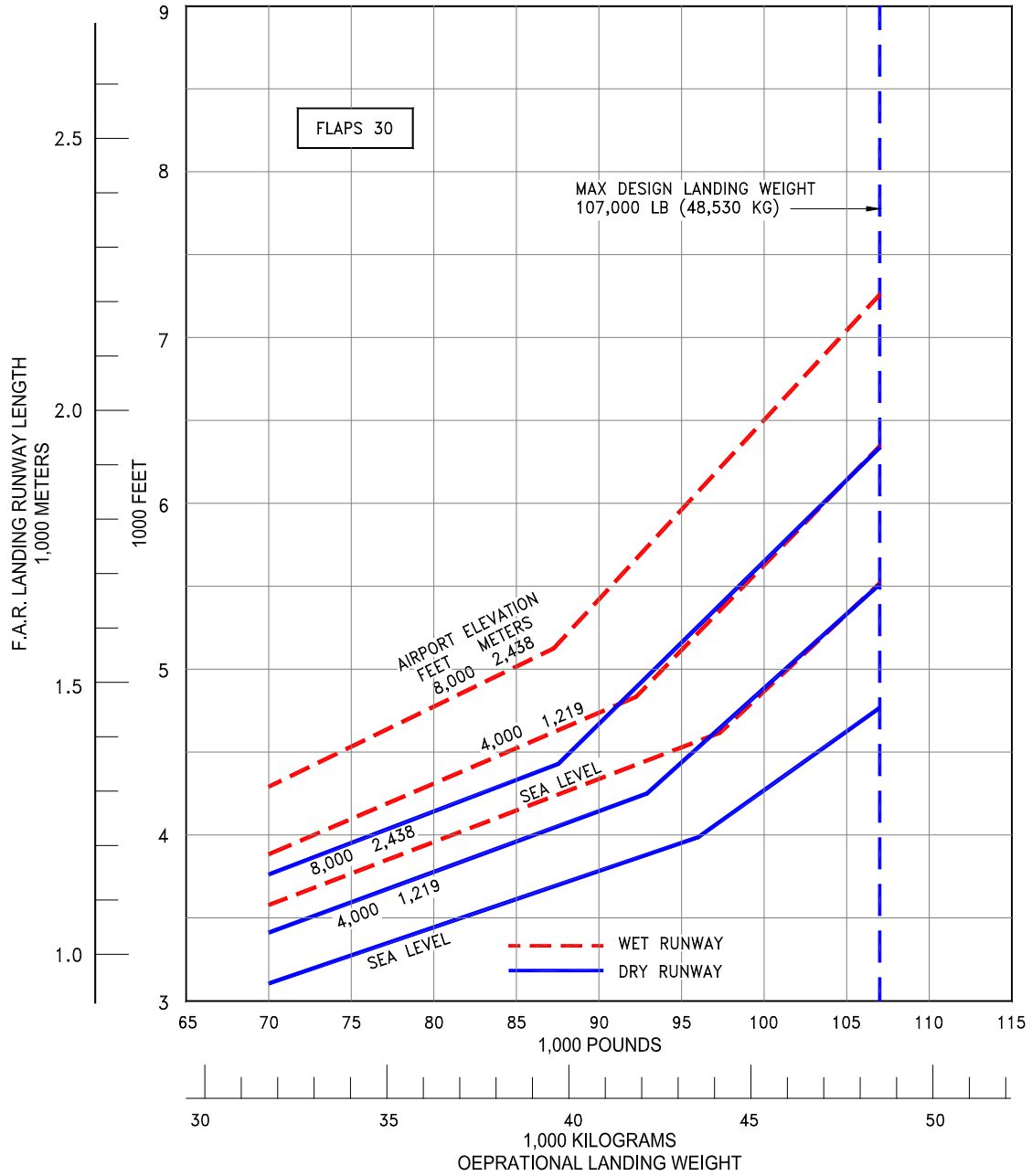

3.4.9 F.A.R. Landing Runway Length Requirements - Flaps 15: Model 737-200ADV, -200C

NOTES:

- * $V_{APP} = 1.3V_s$
- * ZERO WIND
- * FLAP POSITION 25
- * AUTOMATIC SPEED BRAKES
- * CONSULT WITH USING AIRLINE FOR SPECIFIC PROCEDURE PRIOR TO FACILITY DESIGN

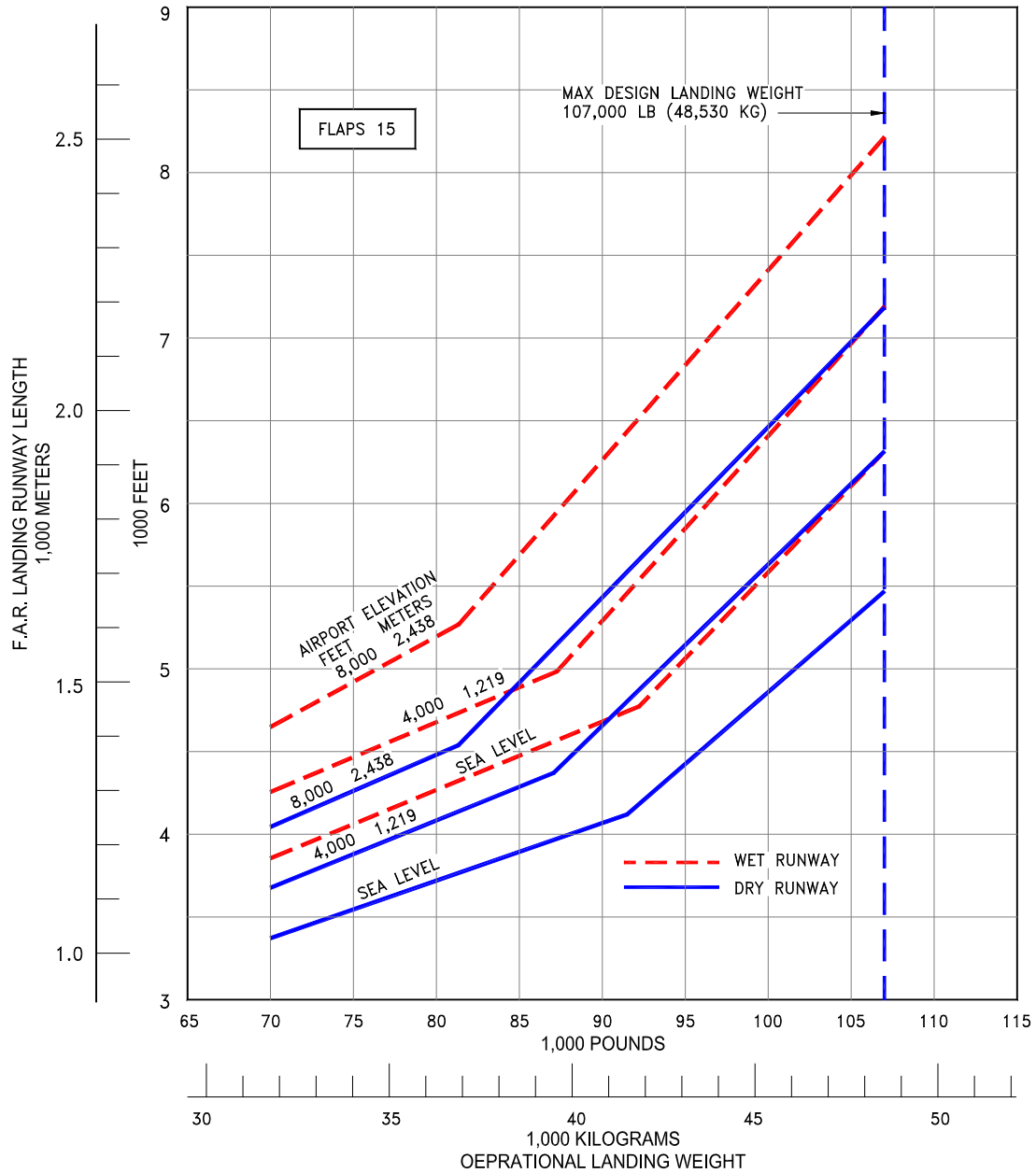

D6-58325-6

3.4.10 F.A.R. Landing Runway Length Requirements - Flaps 40: Model 737-300

NOTES:

- * $V_{APP} = 1.3V_S$
- * ZERO WIND, ZERO RUNWAY GRADIENT
- * FLAP POSITION 40
- * AUTOMATIC SPEED BRAKES
- * CONSULT WITH USING AIRLINE FOR SPECIFIC PROCEDURE PRIOR TO FACILITY DESIGN

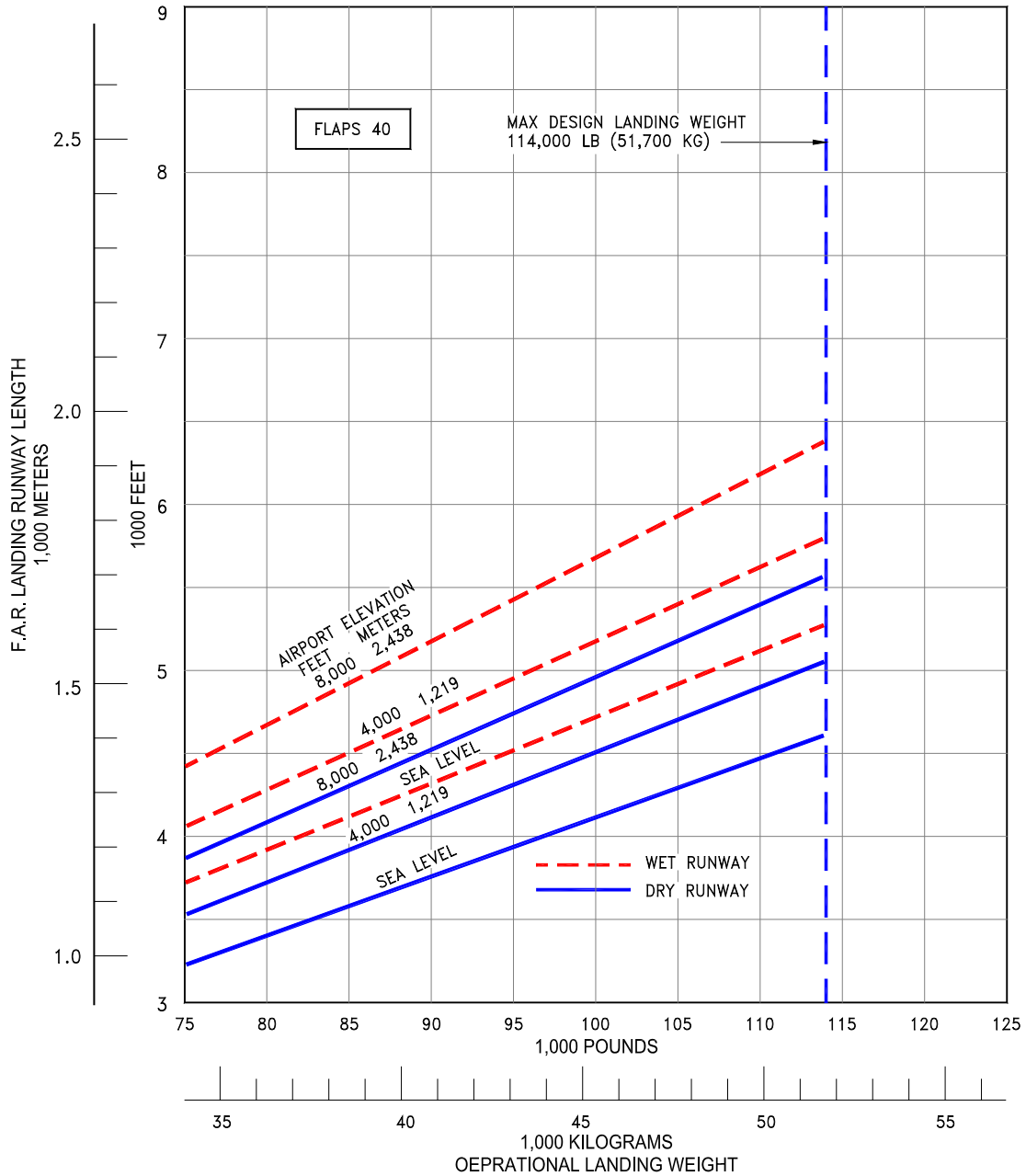

D6-58325-6

3.4.11 F.A.R. Landing Runway Length Requirements - Flaps 30: Model 737-300

NOTES:

- * $V_{APP} = 1.3V_S$
- * ZERO WIND, ZERO RUNWAY GRADIENT
- * FLAP POSITION 30
- * AUTOMATIC SPEED BRAKES
- * CONSULT WITH USING AIRLINE FOR SPECIFIC PROCEDURE PRIOR TO FACILITY DESIGN

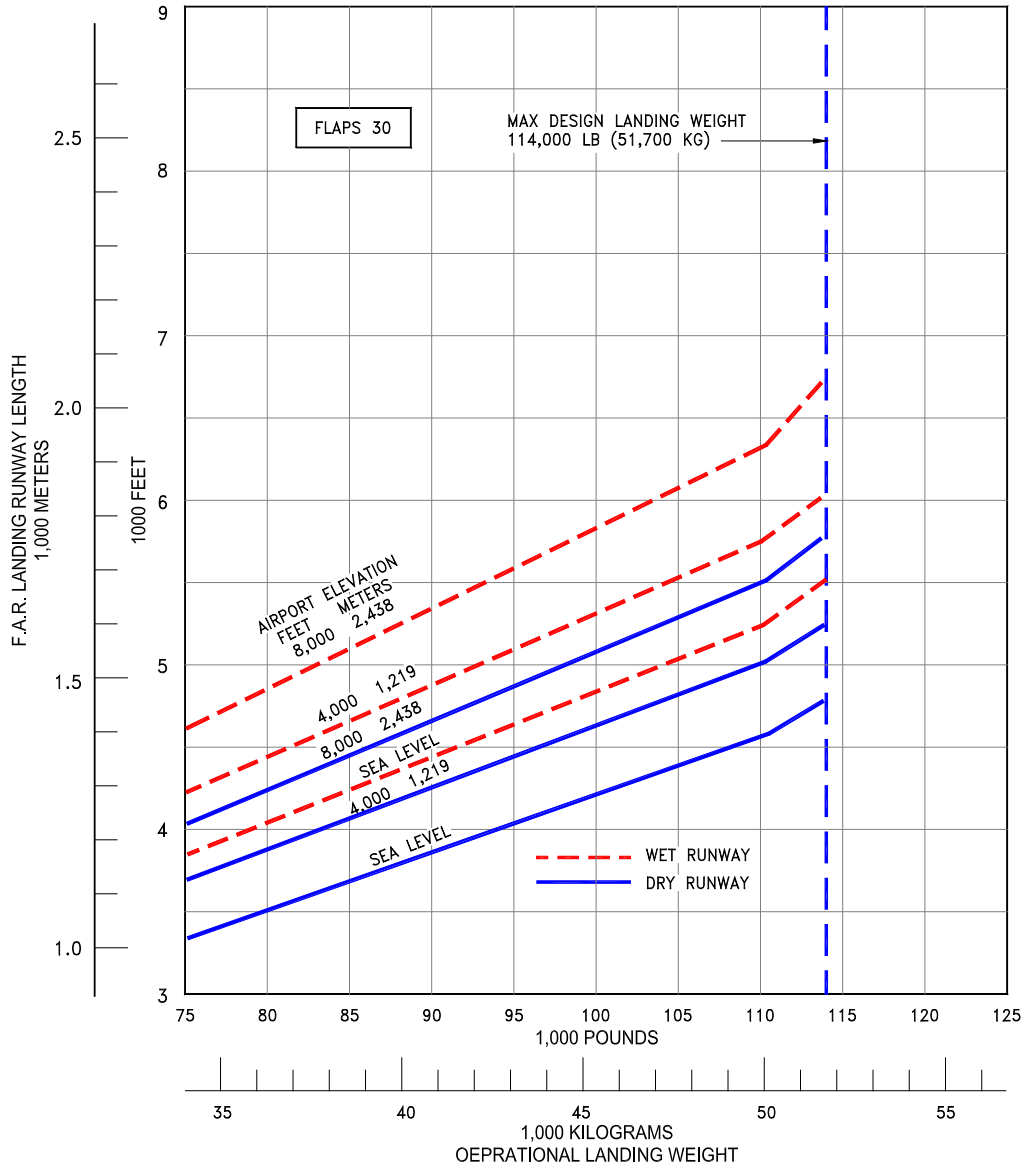

3.4.12 F.A.R. Landing Runway Length Requirements - Flaps 15: Model 737-300

NOTES:

- * $V_{APP} = 1.3V_S$
- * ZERO WIND, ZERO RUNWAY GRADIENT
- * FLAP POSITION 15
- * AUTOMATIC SPEED BRAKES
- * CONSULT WITH USING AIRLINE FOR SPECIFIC PROCEDURE PRIOR TO FACILITY DESIGN

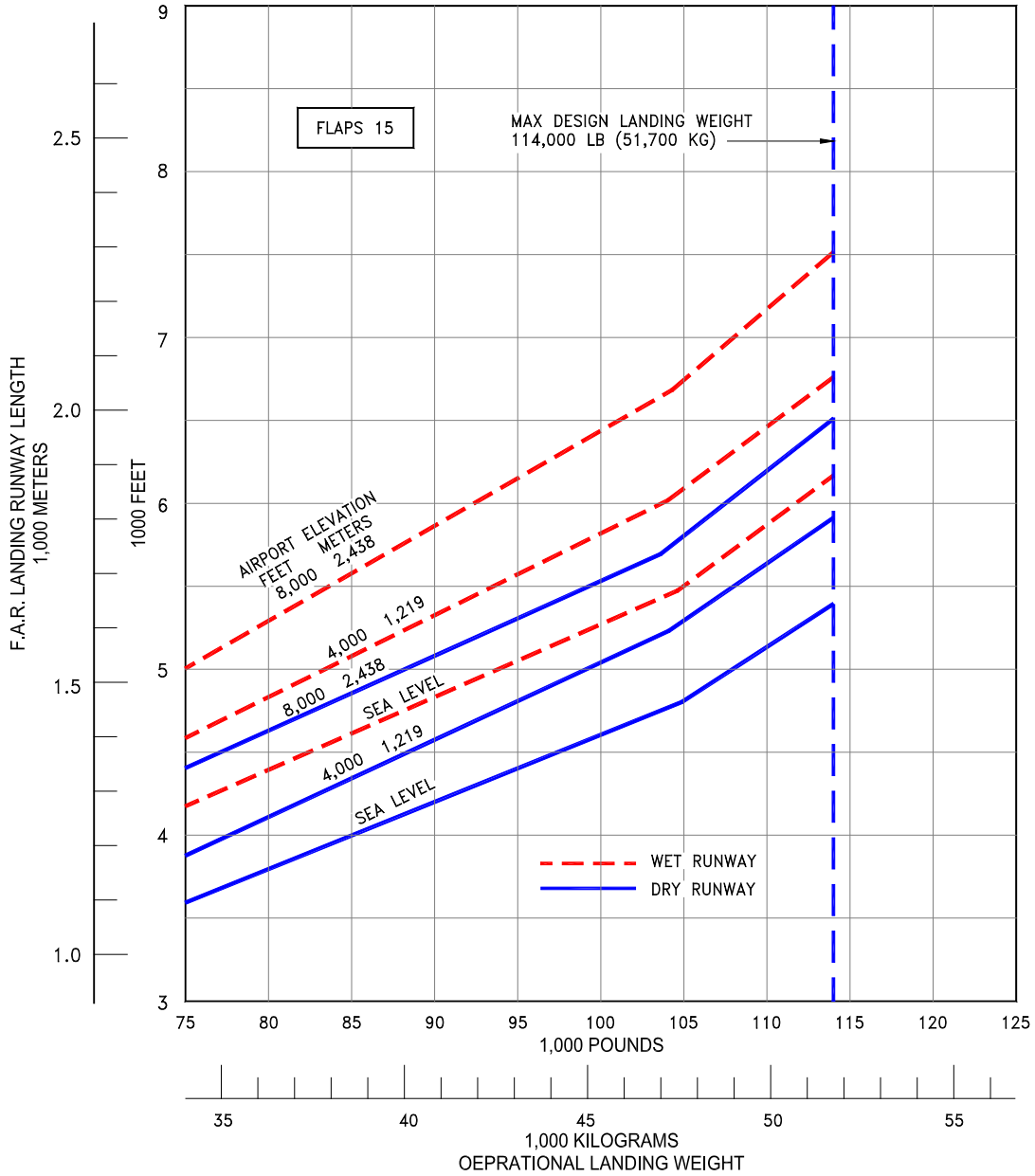

3.4.13 F.A.R. Landing Runway Length Requirements - Flaps 40: Model 737-400

NOTES:

- * $V_{APP} = 1.3V_S$
- * ZERO WIND, ZERO RUNWAY GRADIENT
- * FLAP POSITION 40
- * AUTOMATIC SPEED BRAKES
- * CONSULT WITH USING AIRLINE FOR SPECIFIC PROCEDURE PRIOR TO FACILITY DESIGN

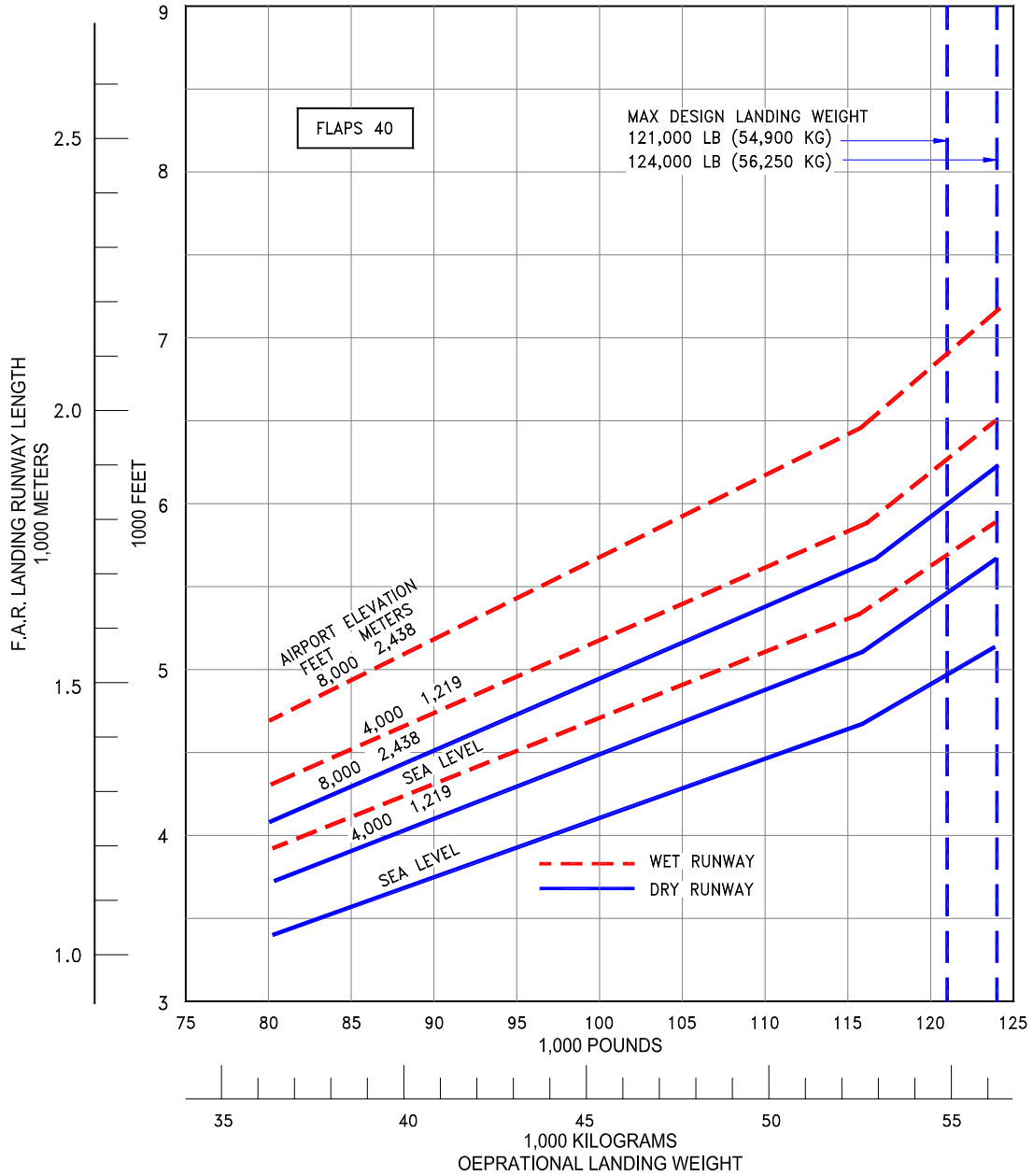

D6-58325-6

3.4.14 F.A.R. Landing Runway Length Requirements - Flaps 30: Model 737-400

NOTES:

- * $V_{APP} = 1.3V_S$
- * ZERO WIND, ZERO RUNWAY GRADIENT
- * FLAP POSITION 30
- * AUTOMATIC SPEED BRAKES
- * CONSULT WITH USING AIRLINE FOR SPECIFIC PROCEDURE PRIOR TO FACILITY DESIGN

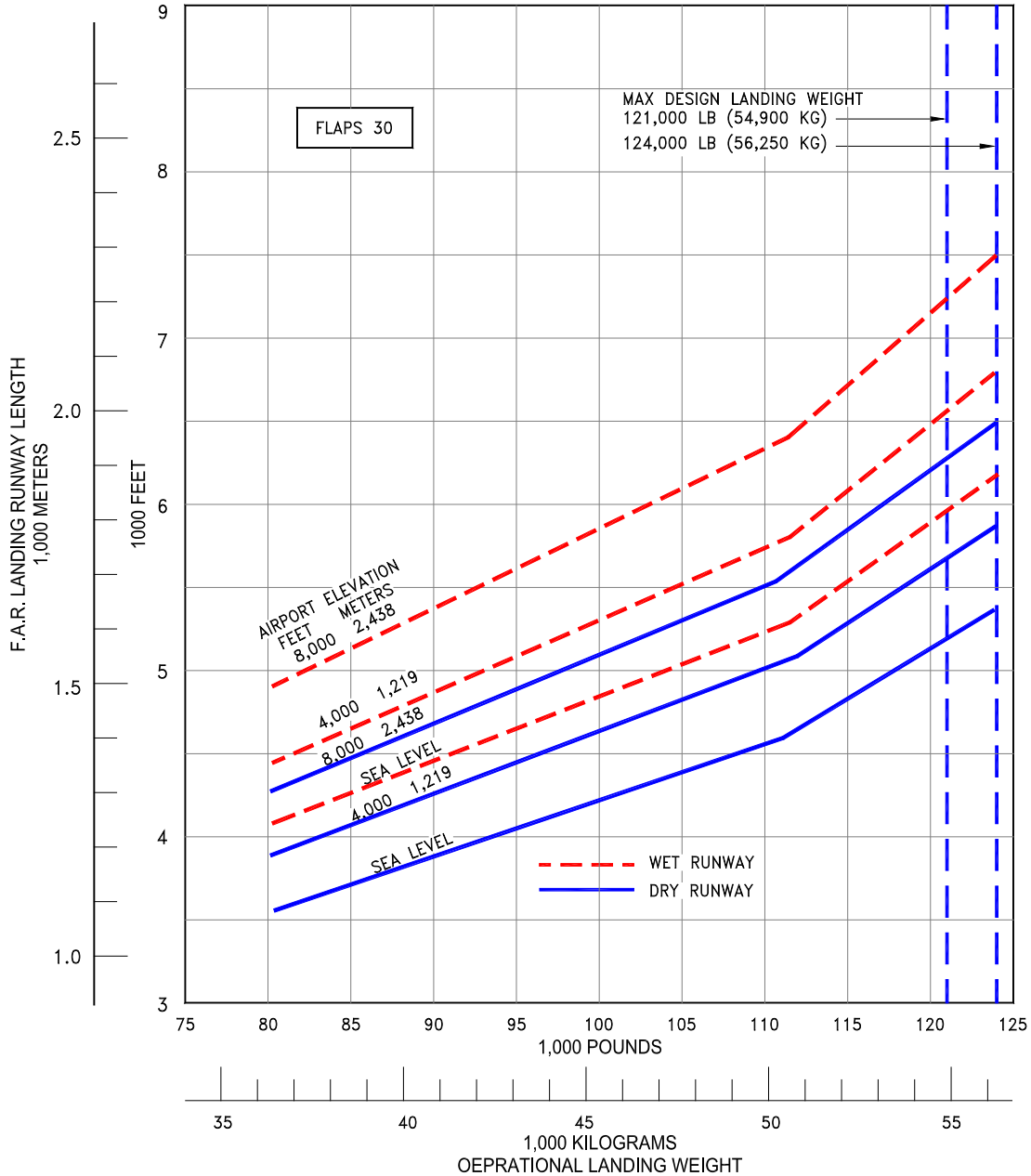

D6-58325-6

3.4.15 F.A.R. Landing Runway Length Requirements - Flaps 15: Model 737-400

NOTES:

- * $V_{APP} = 1.3V_S$
- * ZERO WIND, ZERO RUNWAY GRADIENT
- * FLAP POSITION 15
- * AUTOMATIC SPEED BRAKES
- * CONSULT WITH USING AIRLINE FOR SPECIFIC PROCEDURE PRIOR TO FACILITY DESIGN

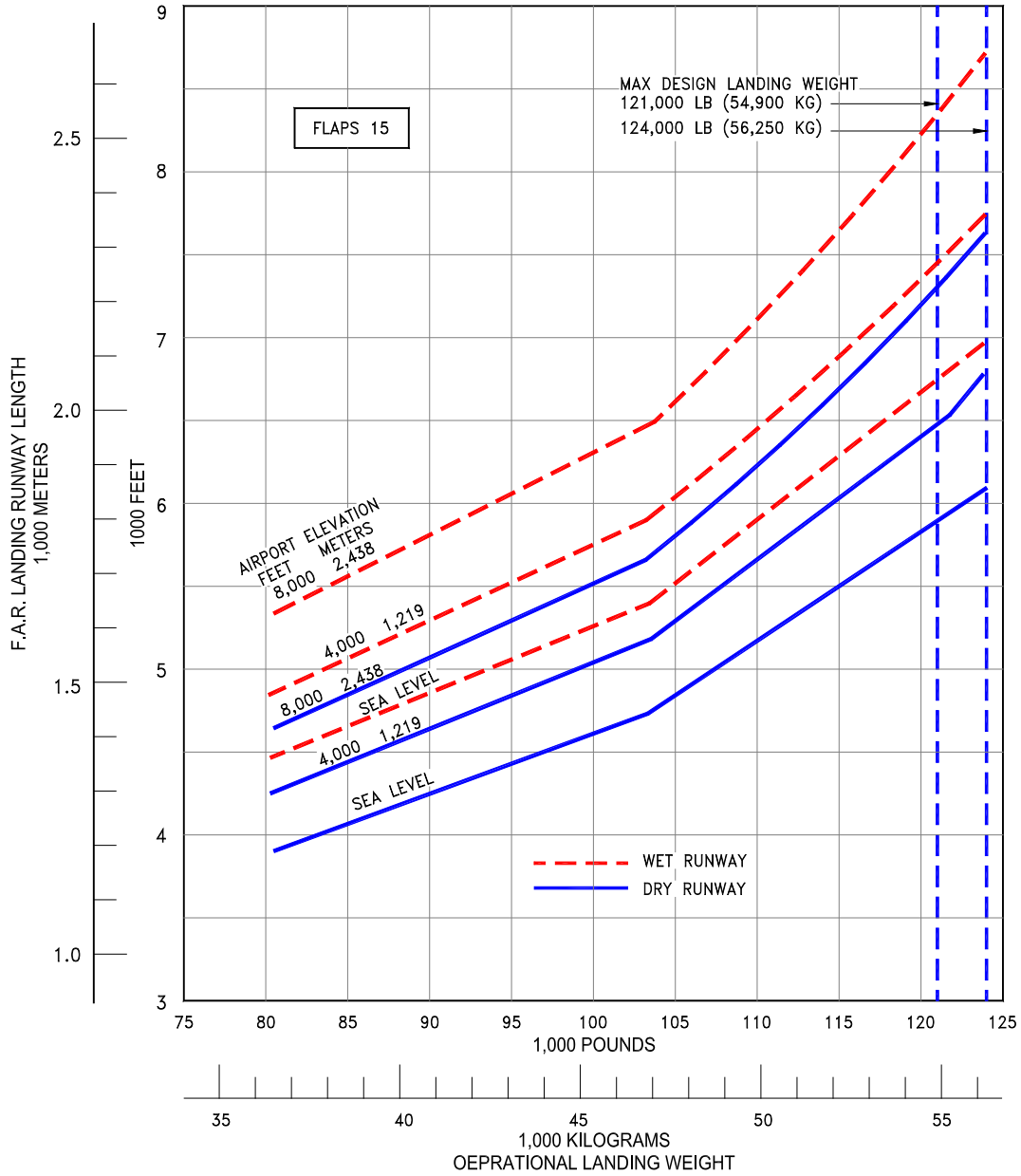

D6-58325-6

3.4.16 F.A.R. Landing Runway Length Requirements - Flaps 40: Model 737-500

- NOTES:
- * $V_{APP} = 1.3V_S$
 - * ZERO WIND, ZERO RUNWAY GRADIENT
 - * FLAP POSITION 40
 - * AUTOMATIC SPEED BRAKES
 - * CONSULT WITH USING AIRLINE FOR SPECIFIC PROCEDURE PRIOR TO FACILITY DESIGN

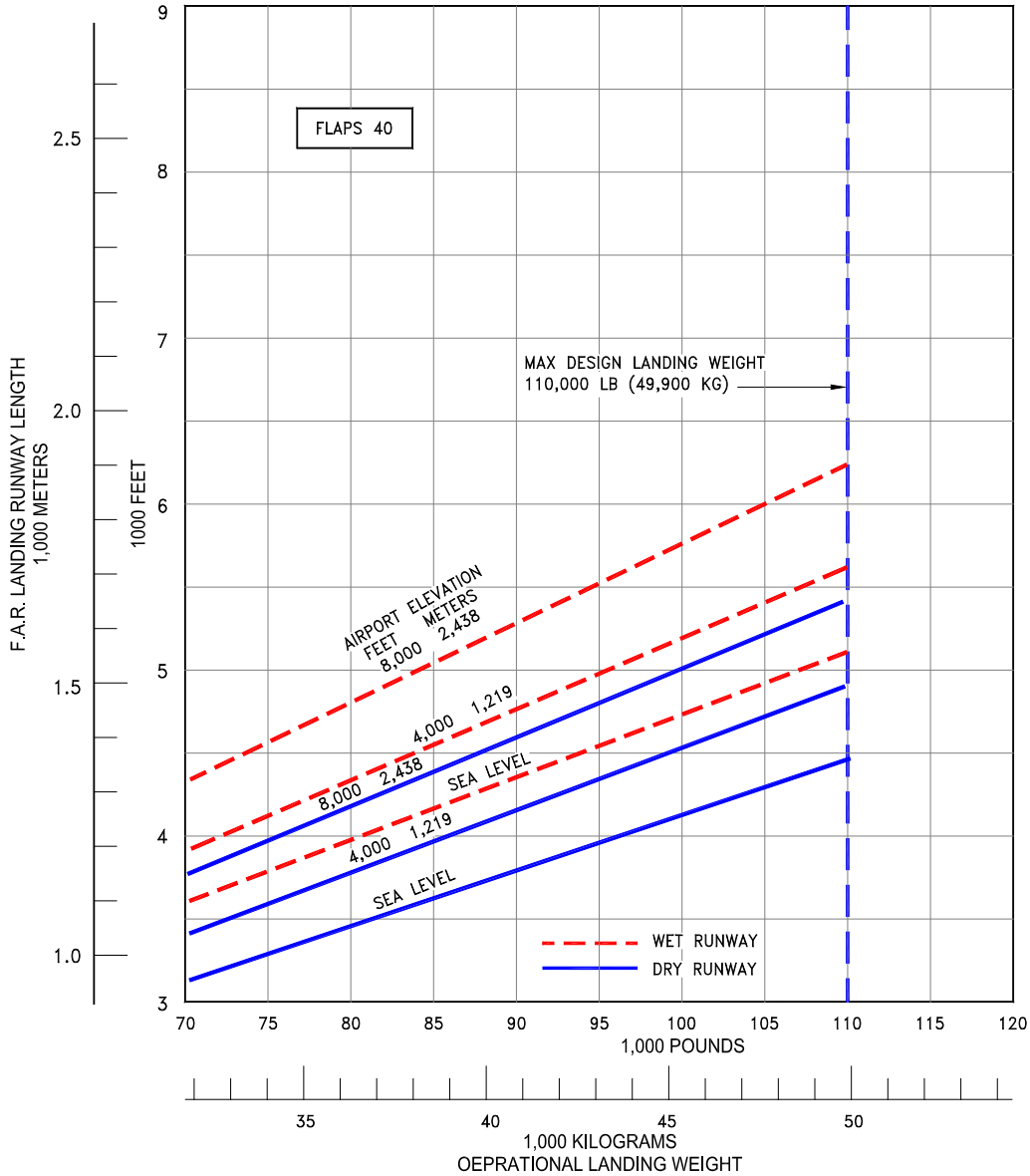

3.4.17 F.A.R. Landing Runway Length Requirements - Flaps 30: Model 737-500

NOTES:

- * $V_{APP} = 1.3V_S$
- * ZERO WIND, ZERO RUNWAY GRADIENT
- * FLAP POSITION 30
- * AUTOMATIC SPEED BRAKES
- * CONSULT WITH USING AIRLINE FOR SPECIFIC PROCEDURE PRIOR TO FACILITY DESIGN

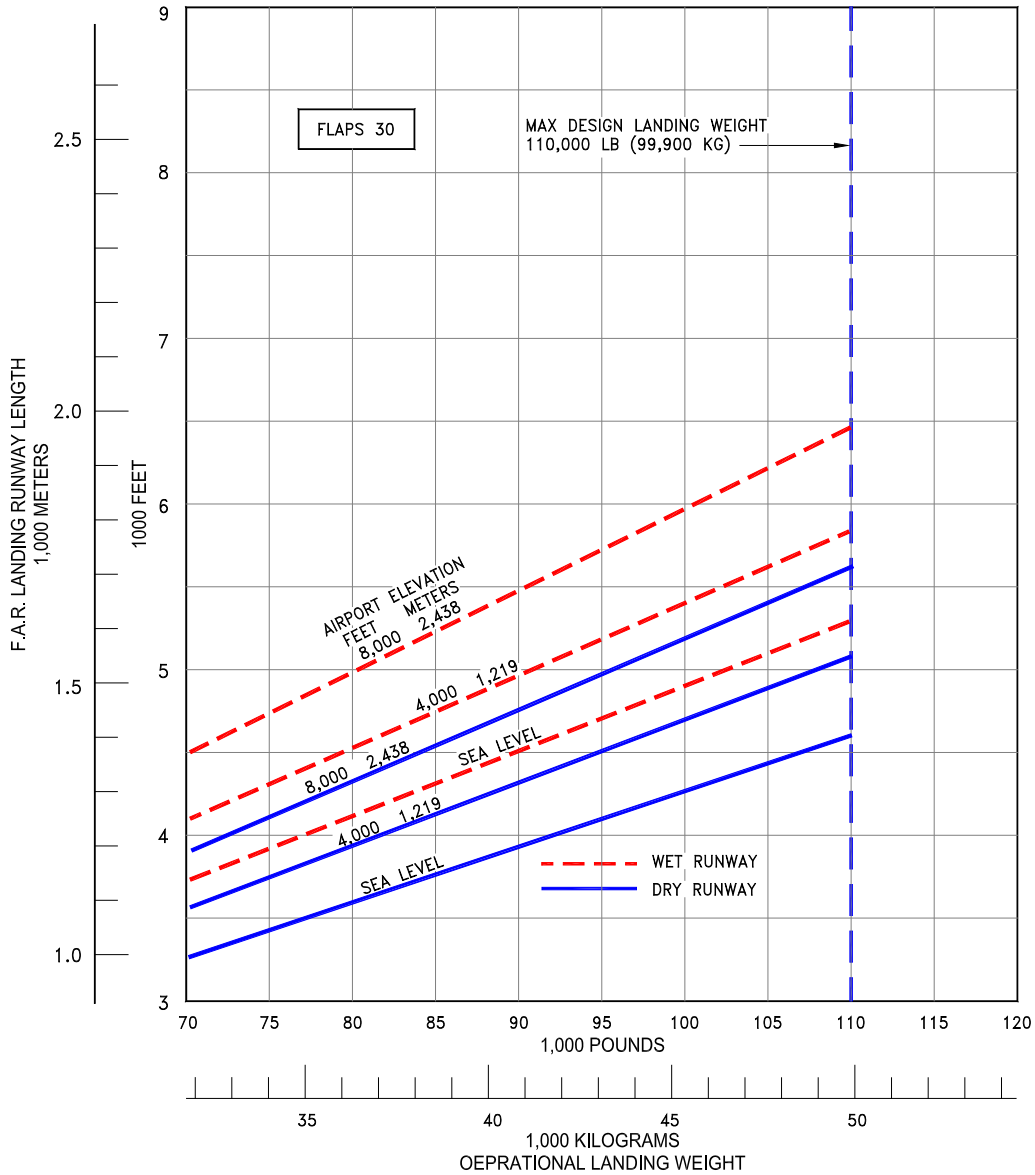

3.4.18 F.A.R. Landing Runway Length Requirements - Flaps 15: Model 737-500

NOTES:

- * $V_{APP} = 1.3V_S$
- * ZERO WIND, ZERO RUNWAY GRADIENT
- * FLAP POSITION 15
- * AUTOMATIC SPEED BRAKES
- * CONSULT WITH USING AIRLINE FOR SPECIFIC PROCEDURE PRIOR TO FACILITY DESIGN

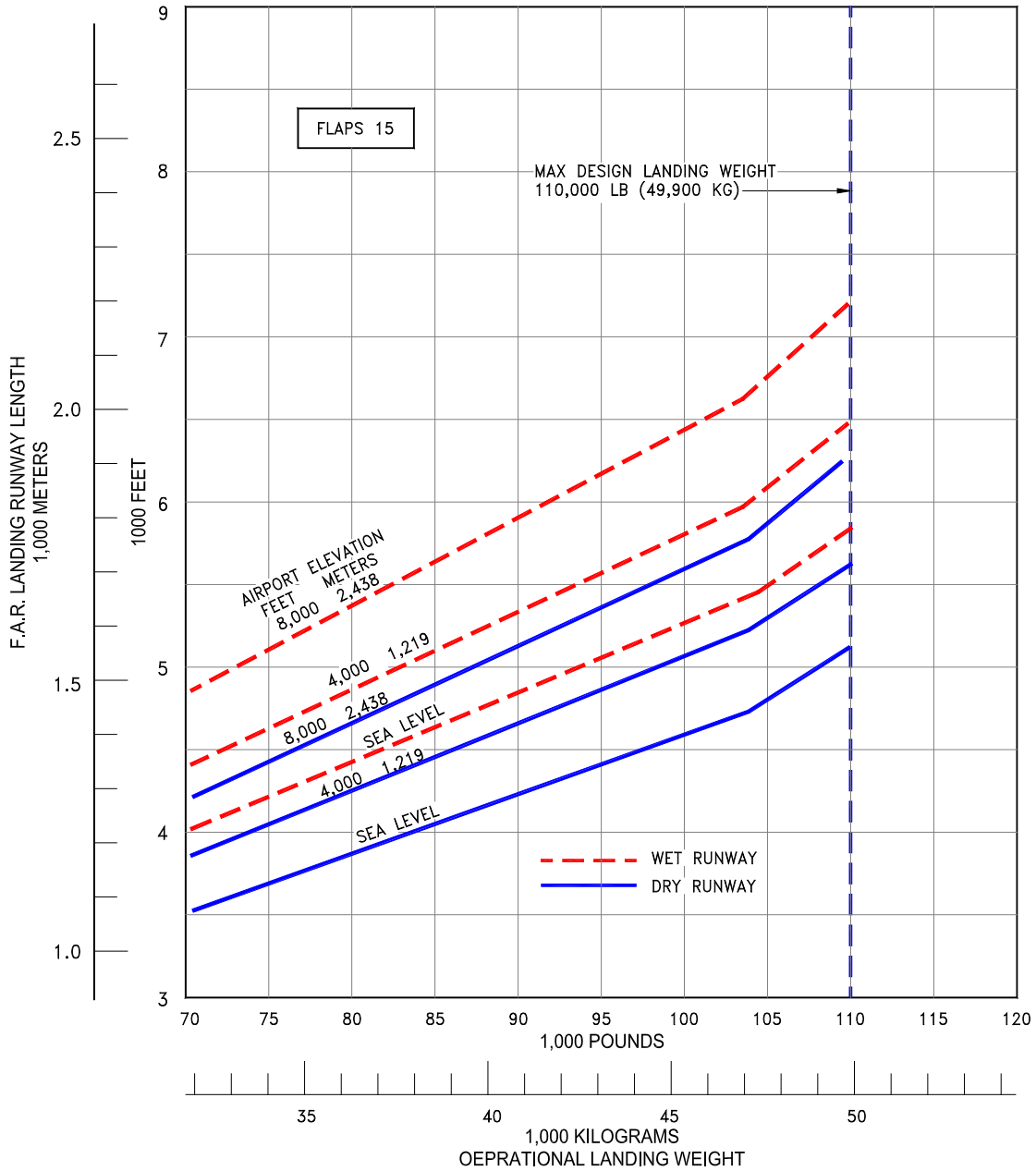

4.0 AIRPLANE PERFORMANCE

4.1 GENERAL INFORMATION

This section provides airplane turning capability and maneuvering characteristics.

For ease of presentation, these data have been determined from the theoretical limits imposed by the geometry of the aircraft, and where noted, provide for a normal allowance for tire slippage. As such, they reflect the turning capability of the aircraft in favorable operating circumstances. These data should be used only as guidelines for the method of determination of such parameters and for the maneuvering characteristics of this aircraft.

In the ground operating mode, varying airline practices may demand that more conservative turning procedures be adopted to avoid excessive tire wear and reduce possible maintenance problems. Airline operating procedures will vary in the level of performance over a wide range of operating circumstances throughout the world. Variations from standard aircraft operating patterns may be necessary to satisfy physical constraints within the maneuvering area, such as adverse grades, limited area, or high risk of jet blast damage. For these reasons, ground maneuvering requirements should be coordinated with the using airlines prior to layout planning.

Section 4.2 presents turning radii for various nose gear steering angles. Radii for the main and nose gears are measured from the turn center to the outside of the tire.

Section 4.3 shows data on minimum width of pavement required for 180° turn.

Section 4.4 provides pilot visibility data from the cockpit and the limits of ambinocular vision through the windows. Ambinocular vision is defined as the total field of vision seen simultaneously by both eyes.

Section 4.5 shows approximate wheel paths for various runway and taxiway turn scenarios on a 100 ft (30 m) runway and 50 ft (15 m) taxiway system. Boeing 737 Series aircraft are capable of operating on 100 ft wide runways. However, for design purposes, the FAA and ICAO recommend that the minimum runway width for the 737 Series aircraft is 150 ft (45 m).

The pavement fillet geometries are based on the FAA's Advisory Circular (AC) 150/5300-13 (thru change 16). They represent typical fillet geometries built at many airports worldwide. ICAO and other civil aviation authorities publish many different fillet design methods. Prior to determining the size of fillets, airports are advised to check with the airlines regarding the operating procedures and aircraft types they expect to use at the airport. Further, given the cost of modifying fillets and the operational impact to ground movement and air traffic during construction, airports may want to design critical fillets for larger aircraft types to minimize future operational impacts.

Section 4.6 illustrates a typical runway holding bay configuration.

4.2 TURNING RADII

4.2.1 Turning Radii – No Slip Angle: Model 737-100

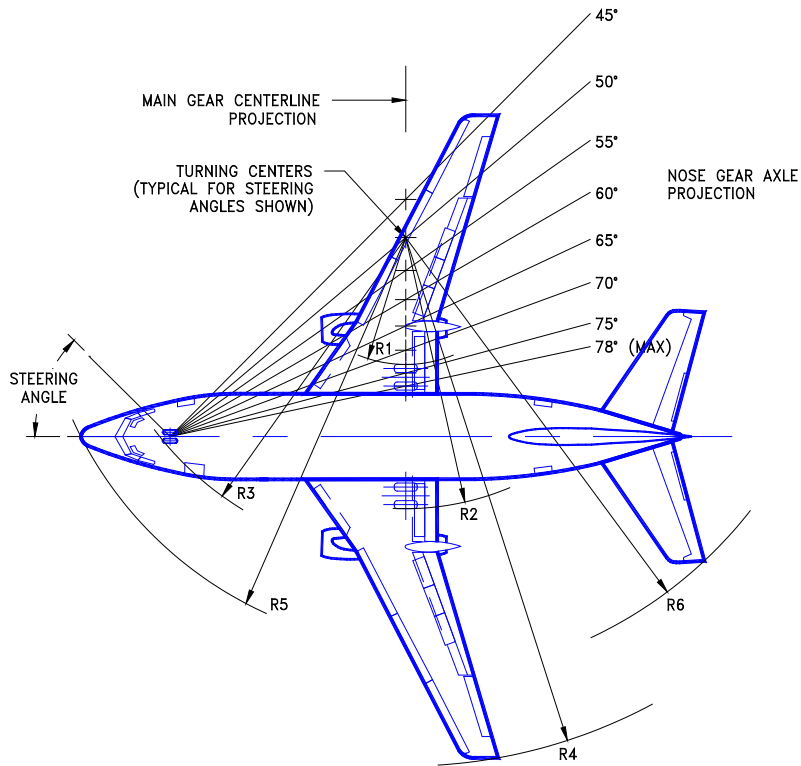

NOTES: * ACTUAL OPERATING TURNING RADII MAY BE GREATER THAN SHOWN
 * CONSULT WITH AIRLINE FOR SPECIFIC OPERATING PROCEDURE

STEERING ANGLE (DEG)	R1 INNER GEAR		R2 OUTER GEAR		R3 NOSE GEAR		R4 WINGTIP		R5 NOSE		R6 TAIL	
	FT	M	FT	M	FT	M	FT	M	FT	M	FT	M
30	49.0	14.9	69.9	21.3	69.5	21.2	106.7	32.5	75.9	23.1	90.4	27.6
35	38.5	11.7	59.4	18.1	60.8	18.5	96.4	29.4	68.1	20.8	81.7	24.9
40	30.4	9.3	51.3	15.6	54.3	16.6	88.3	26.9	62.5	19.1	75.1	22.9
45	23.8	7.3	44.7	13.6	49.5	15.1	81.8	24.9	58.4	17.8	70.1	21.4
50	18.3	5.6	39.2	12.0	45.7	13.9	76.4	23.3	55.4	16.9	66.1	20.1
55	13.6	4.1	34.5	10.5	42.8	13.1	71.7	21.9	53.0	16.2	62.8	19.1
60	9.4	2.9	30.3	9.2	40.6	12.4	67.6	20.6	51.3	15.6	60.1	18.3
65	5.5	1.7	26.4	8.1	38.8	11.8	63.8	19.5	49.9	15.2	57.8	17.6
70	2.0	.6	22.9	7.0	37.5	11.4	60.4	18.4	48.9	14.9	55.8	17.0
75	1.3	.4	19.6	6.0	36.5	11.1	57.2	17.4	48.2	14.7	54.0	16.5
78 (MAX)	3.2	1.0	17.7	5.4	36.0	11.0	55.3	16.9	47.9	14.6	53.1	16.2

4.2.2 Turning Radii – No Slip Angle: Model 737-200

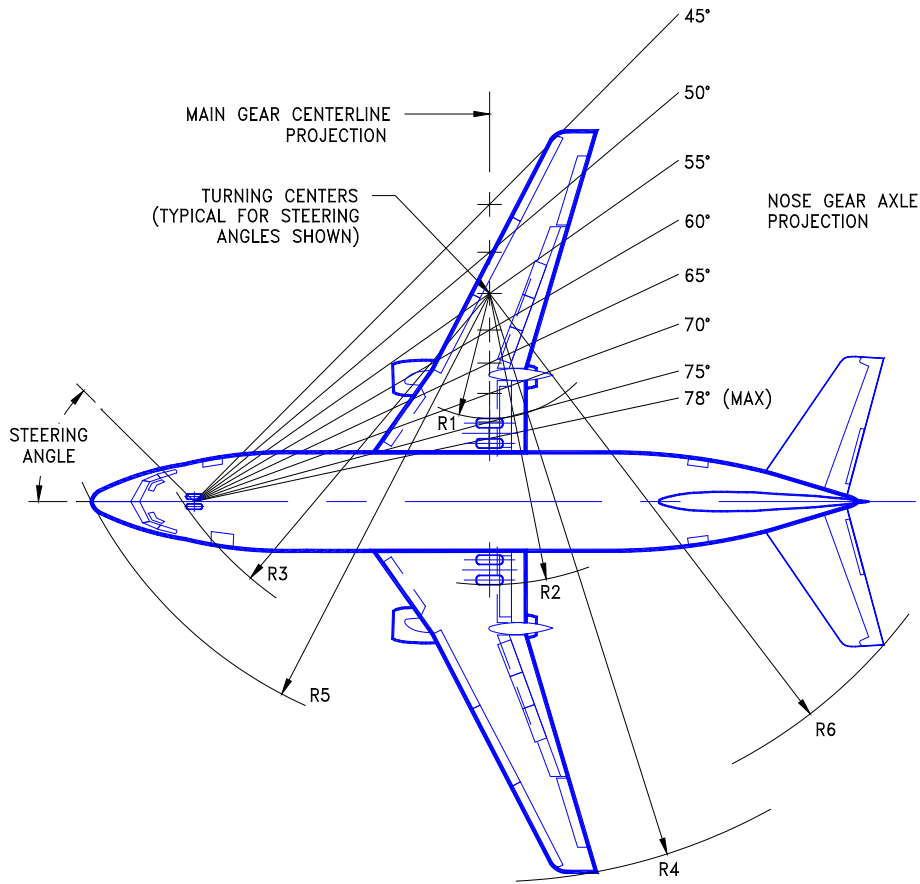

NOTES: * ACTUAL OPERATING TURNING RADII MAY BE GREATER THAN SHOWN
 * CONSULT WITH AIRLINE FOR SPECIFIC OPERATING PROCEDURE

STEERING ANGLE (DEG)	R1 INNER GEAR		R2 OUTER GEAR		R3 NOSE GEAR		R4 WINGTIP		R5 NOSE		R6 TAIL	
	FT	M	FT	M	FT	M	FT	M	FT	M	FT	M
30	54.2	16.5	75.1	22.9	75.5	23.0	111.9	34.1	81.9	25.0	96.4	29.4
35	42.8	13.1	63.7	19.4	66.0	20.1	100.6	30.7	73.3	22.3	86.9	26.5
40	34.0	10.4	54.9	16.7	59.0	18.0	91.9	28.0	67.1	20.5	79.8	24.3
45	26.8	8.2	47.7	14.6	53.7	16.4	84.8	25.8	62.6	19.1	74.4	22.7
50	20.8	6.4	41.7	12.7	49.6	15.1	78.9	24.0	59.2	18.1	70.0	21.3
55	15.7	4.8	36.6	11.1	46.5	14.2	73.8	22.5	56.7	17.3	66.5	20.3
60	11.1	3.4	32.0	9.7	44.0	13.4	69.3	21.1	54.7	16.7	63.5	19.4
65	6.9	2.1	27.8	8.5	42.1	12.8	65.2	19.9	53.2	16.2	61.0	18.6
70	3.1	1.0	24.0	7.3	40.6	12.4	61.5	18.7	52.1	15.9	58.9	17.9
75	0.5	.1	20.4	6.2	39.6	12.1	58.0	17.7	51.3	15.6	57.0	17.4
78 (MAX)	2.5	.8	18.4	5.6	39.1	11.9	56.0	17.1	50.9	15.5	56.1	17.1

4.2.3 Turning Radii – No Slip Angle: Model 737-300

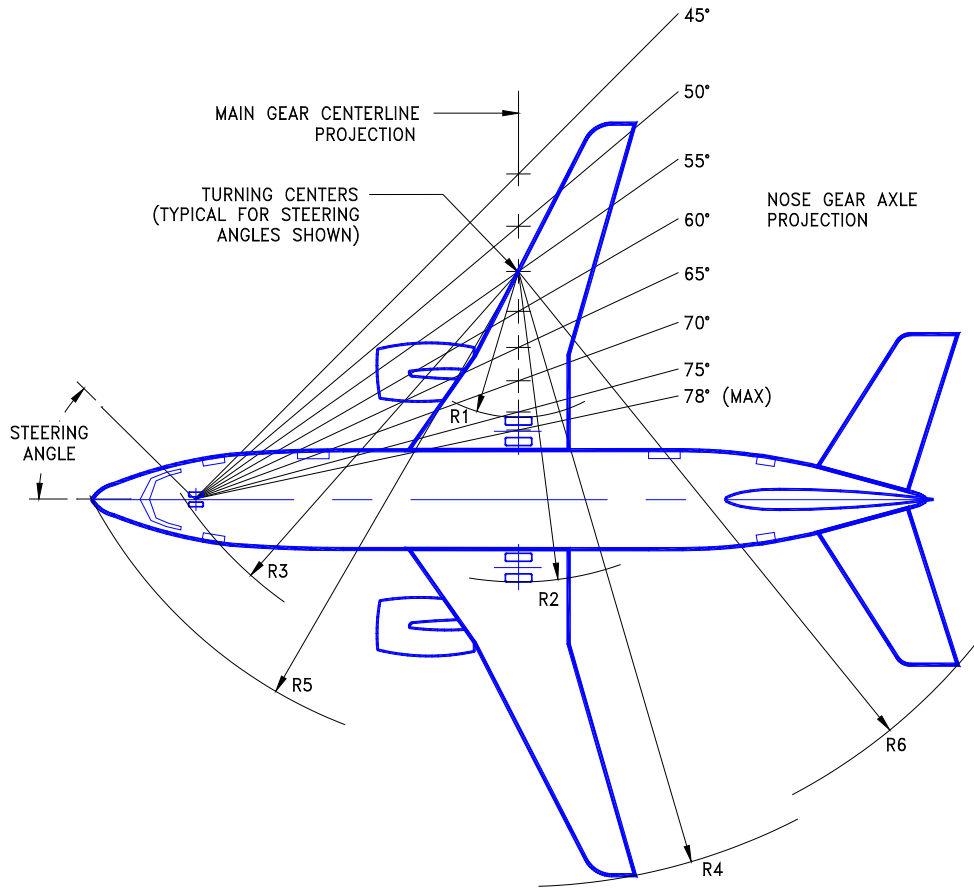

NOTES: * ACTUAL OPERATING TURNING RADII MAY BE GREATER THAN SHOWN
 * CONSULT WITH AIRLINE FOR SPECIFIC OPERATING PROCEDURE

STEERING ANGLE (DEG)	R1 INNER GEAR		R2 OUTER GEAR		R3 NOSE GEAR		R4 WING TIP		R5 NOSE		R6 TAIL	
	FT	M	FT	M	FT	M	FT	M	FT	M	FT	M
30	60.2	18.4	81.1	24.7	82.5	25.2	119.0	36.3	88.9	27.1	107.1	32.6
35	47.8	14.6	68.7	20.9	72.1	22.0	106.7	32.5	79.4	24.2	96.7	29.5
40	38.2	11.6	59.1	18.0	64.4	19.6	97.2	29.6	72.7	22.1	89.0	27.1
45	30.3	9.3	51.2	15.6	58.6	17.9	89.5	27.3	67.7	20.6	83.0	25.3
50	23.8	7.2	44.7	13.6	54.2	16.5	83.0	25.3	63.9	19.5	78.3	23.9
55	18.1	5.5	39.0	11.9	50.8	15.5	77.4	23.6	61.1	18.6	74.4	22.7
60	13.1	4.0	34.0	10.4	48.1	14.6	72.5	22.1	58.9	18.0	71.2	21.7
65	8.6	2.6	29.5	9.0	46.0	14.0	68.1	20.8	57.3	17.5	68.4	20.9
70	4.4	1.3	25.3	7.7	44.4	13.5	64.0	19.5	56.0	17.1	66.1	20.1
75	0.5	.1	21.4	6.5	43.2	13.2	60.2	18.4	55.1	16.8	64.0	19.5
78 (MAX)	1.8	.5	19.1	5.8	42.7	13.0	58.0	17.7	54.7	16.7	63.0	19.2

4.2.4 Turning Radii – No Slip Angle: Model 737-300W

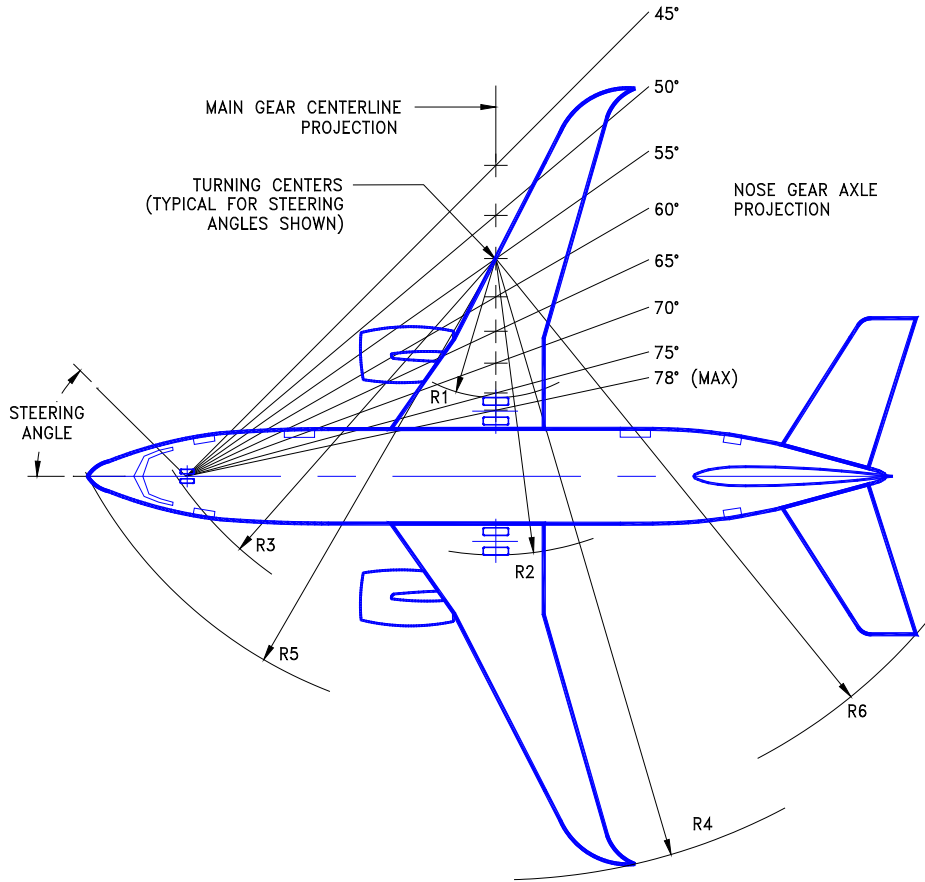

NOTES: * ACTUAL OPERATING TURNING RADII MAY BE GREATER THAN SHOWN
 * CONSULT WITH AIRLINE FOR SPECIFIC OPERATING PROCEDURE

STEERING ANGLE (DEG)	R1 INNER GEAR		R2 OUTER GEAR		R3 NOSE GEAR		R4 WING TIP		R5 NOSE		R6 TAIL	
	FT	M	FT	M	FT	M	FT	M	FT	M	FT	M
30	60.2	18.4	81.1	24.7	82.5	25.2	123.6	37.3	88.9	27.1	107.1	32.6
35	47.8	14.6	68.7	20.9	72.1	22.0	111.3	33.9	79.4	24.2	96.7	29.5
40	38.2	11.6	59.1	18.0	64.4	19.6	101.9	31.1	72.7	22.1	89.0	27.1
45	30.3	9.3	51.2	15.6	58.6	17.9	94.2	28.7	67.7	20.6	83.0	25.3
50	23.8	7.2	44.7	13.6	54.2	16.5	87.8	26.8	63.9	19.5	78.3	23.9
55	18.1	5.5	39.0	11.9	50.8	15.5	82.3	25.1	61.1	18.6	74.4	22.7
60	13.1	4.0	34.0	10.4	48.1	14.6	77.5	23.6	58.9	18.0	71.2	21.7
65	8.6	2.6	29.5	9.0	46.0	14.0	73.1	22.3	57.3	17.5	68.4	20.9
70	4.4	1.3	25.3	7.7	44.4	13.5	69.1	21.1	56.0	17.1	66.1	20.1
75	0.5	.1	21.4	6.5	43.2	13.2	65.4	19.9	55.1	16.8	64.0	19.5
78 (MAX)	1.8	.5	19.1	5.8	42.7	13.0	63.2	19.3	54.7	16.7	63.0	19.2

4.2.5 Turning Radii – No Slip Angle: Model 737-400

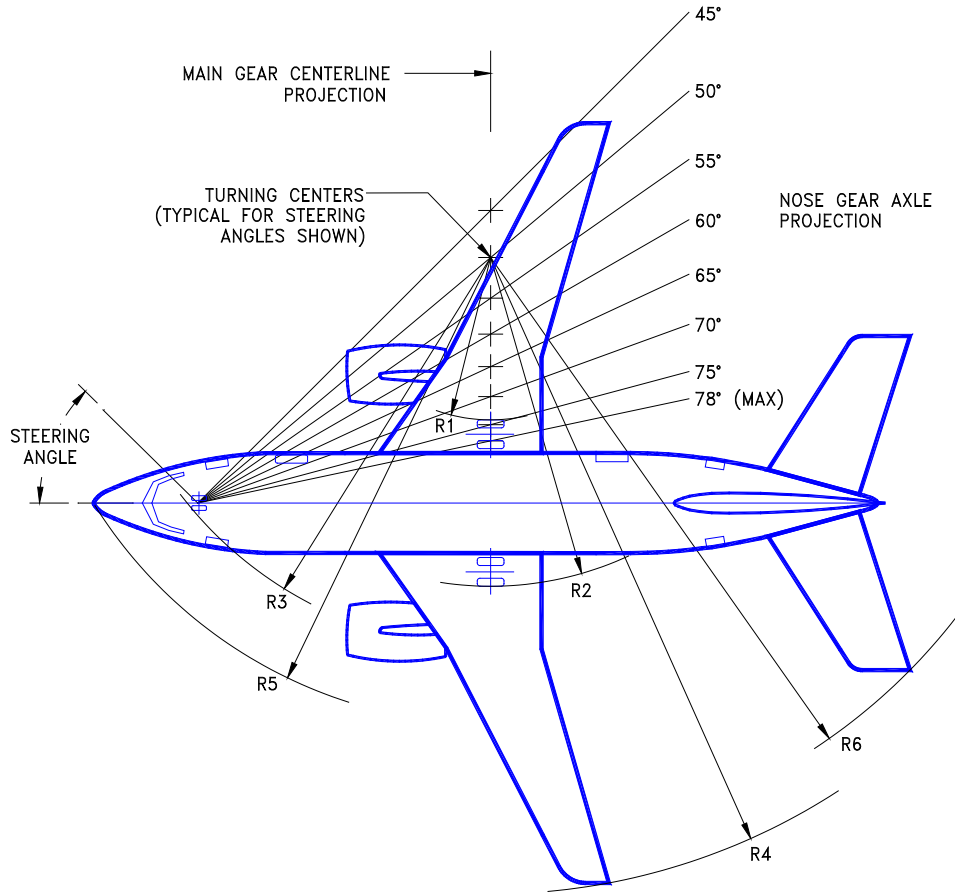

NOTES: * ACTUAL OPERATING TURNING RADII MAY BE GREATER THAN SHOWN
 * CONSULT WITH AIRLINE FOR SPECIFIC OPERATING PROCEDURE

STEERING ANGLE (DEG)	R1 INNER GEAR		R2 OUTER GEAR		R3 NOSE GEAR		R4 WING TIP		R5 NOSE		R6 TAIL	
	FT	M	FT	M	FT	M	FT	M	FT	M	FT	M
30	70.7	21.5	91.6	27.9	94.7	28.8	129.3	39.4	100.9	30.8	118.1	36.0
35	56.4	17.2	77.3	23.6	82.6	25.2	115.2	35.1	89.8	27.4	106.0	32.3
40	45.3	13.8	66.3	20.2	73.8	22.5	104.2	31.8	81.9	25.0	97.1	29.6
45	36.4	11.1	57.3	17.5	67.2	20.5	95.3	29.1	76.1	23.2	90.2	27.5
50	28.8	8.8	49.8	15.2	62.1	18.9	87.9	26.8	71.7	21.9	84.6	25.8
55	22.3	6.8	43.3	13.2	58.2	17.7	81.5	24.8	68.4	20.8	80.2	24.4
60	16.6	5.1	37.5	11.4	55.1	16.8	75.8	23.1	65.8	20.1	76.4	23.3
65	11.4	3.5	32.3	9.8	52.7	16.1	70.8	21.6	63.9	19.5	73.3	22.3
70	6.6	2.0	27.5	8.4	50.8	15.5	66.1	20.1	62.4	19.0	70.6	21.5
75	2.1	0.6	23.0	7.0	49.5	15.1	61.7	18.8	61.3	18.7	68.3	20.8
78 (MAX)	-0.5	-0.2	20.4	6.2	48.9	14.9	59.2	18.0	60.8	18.5	67.1	20.4

D6-58325-6

REV D

March 2023

4-6

4.2.6 Turning Radii – No Slip Angle: Model 737-500

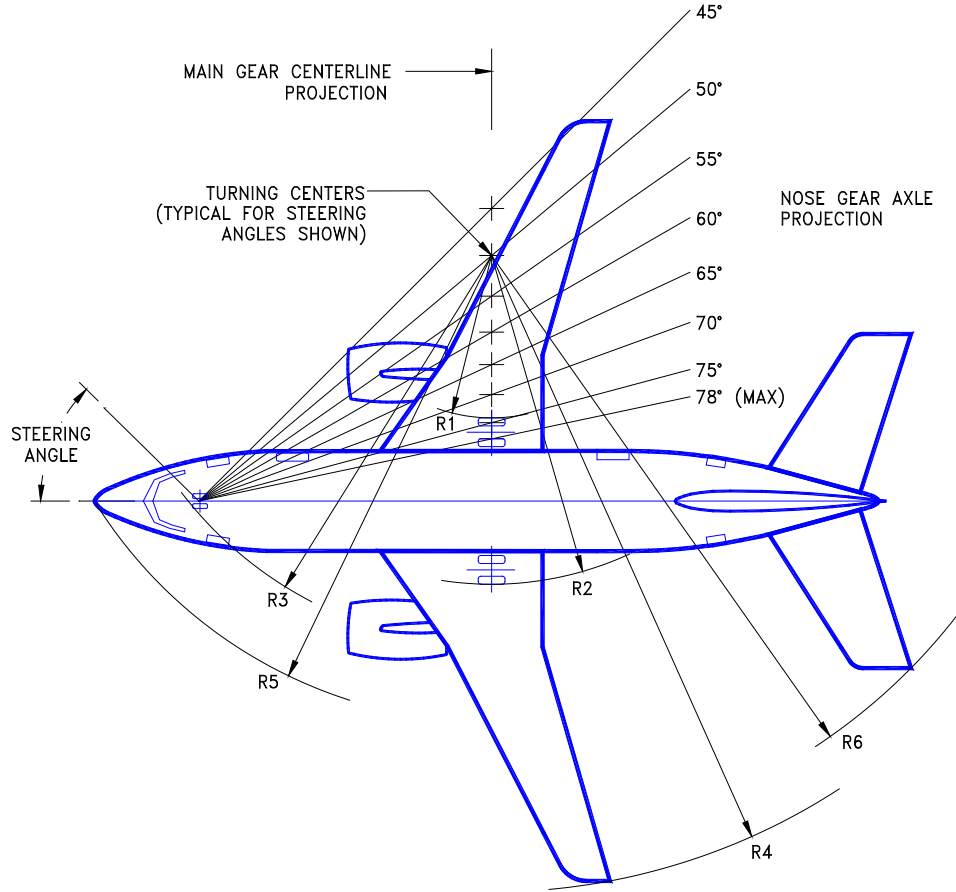

NOTES: * ACTUAL OPERATING TURNING RADII MAY BE GREATER THAN SHOWN
 * CONSULT WITH AIRLINE FOR SPECIFIC OPERATING PROCEDURE

STEERING ANGLE (DEG)	R1 INNER GEAR		R2 OUTER GEAR		R3 NOSE GEAR		R4 WING TIP		R5 NOSE		R6 TAIL	
	FT	M	FT	M	FT	M	FT	M	FT	M	FT	M
30	52.4	16.0	73.3	22.3	73.5	22.4	111.3	33.9	80.0	24.4	98.7	30.1
35	41.4	12.6	62.3	19.0	64.2	19.6	100.4	30.6	71.7	21.8	89.6	27.3
40	32.8	10.0	53.7	16.4	57.4	17.5	91.9	28.0	65.7	20.0	82.7	25.2
45	25.8	7.9	46.7	14.2	52.3	15.9	85.0	25.9	61.4	18.7	77.5	23.6
50	20.0	6.1	40.9	12.5	48.3	14.7	79.3	24.2	58.1	17.7	73.3	22.3
55	15.0	4.6	35.9	10.9	45.3	13.8	74.3	22.7	55.6	17.0	69.8	21.3
60	10.5	3.2	31.4	9.6	42.9	13.1	70.0	21.3	53.8	16.4	67.0	20.4
65	6.5	2.0	27.4	8.3	41.0	12.5	66.1	20.1	52.3	15.9	64.5	19.7
70	2.8	.8	23.7	7.2	39.6	12.1	62.4	19.0	51.2	15.6	62.4	19.0
75	0.7	.2	20.2	6.1	38.5	11.7	59.1	18.0	50.4	15.4	60.6	18.5
78 (MAX)	2.7	.8	18.2	5.5	38.1	11.6	57.1	17.4	50.1	15.3	59.6	18.2

D6-58325-6

REV D

March 2023

4-7

4.3 CLEARANCE RADII

4.3.1 Minimum Turning Radii – 3” Slip Angle: Model 737-100, -200

NOTES:

- 3° TIRE SLIP ANGLE APPROXIMATE ONLY FOR 78° STEERING ANGLE
- CONSULT WITH AIRLINE FOR ACTUAL OPERATING DATA
- DIMENSIONS ROUNDED TO NEAREST 0.1 FT AND 0.1 METER

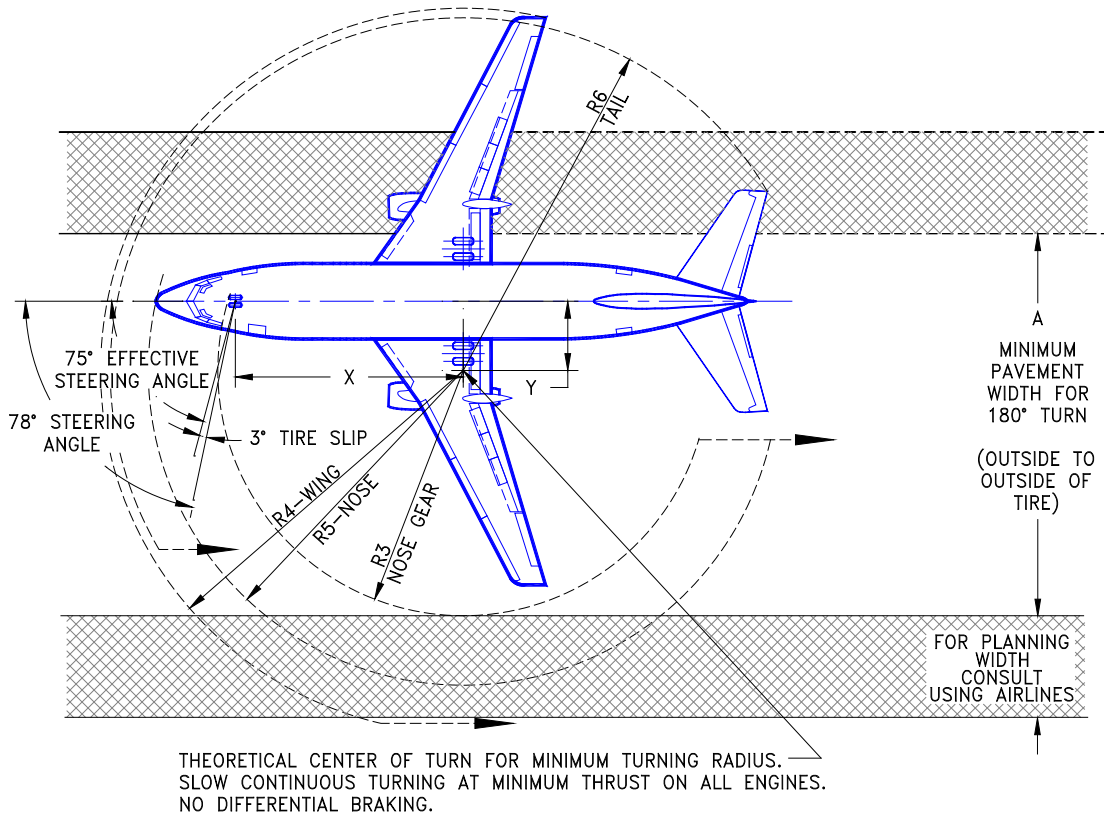

AIRPLANE MODEL	EFFECTIVE TURNING ANGLE (DEG)	X		Y		A		R3		R4		R5		R6	
		FT	M	FT	M	FT	M	FT	M	FT	M	FT	M	FT	M
737-100	75	34.3	10.5	9.2	2.8	56.1	17.1	36.5	11.1	57.2	17.4	48.2	14.7	54.0	16.5
737-200	75	41.3	11.4	10.0	3.0	60.0	18.3	39.6	12.1	58.0	17.7	51.3	15.6	57.0	18.3

4.3.2 Minimum Turning Radii – 3” Slip Angle: Model 737-300, -300W, -400, -500

NOTES:

- 3° TIRE SLIP ANGLE APPROXIMATE ONLY FOR 78° STEERING ANGLE
- CONSULT WITH AIRLINE FOR ACTUAL OPERATING DATA
- DIMENSIONS ROUNDED TO NEAREST 0.1 FT AND 0.1 METER

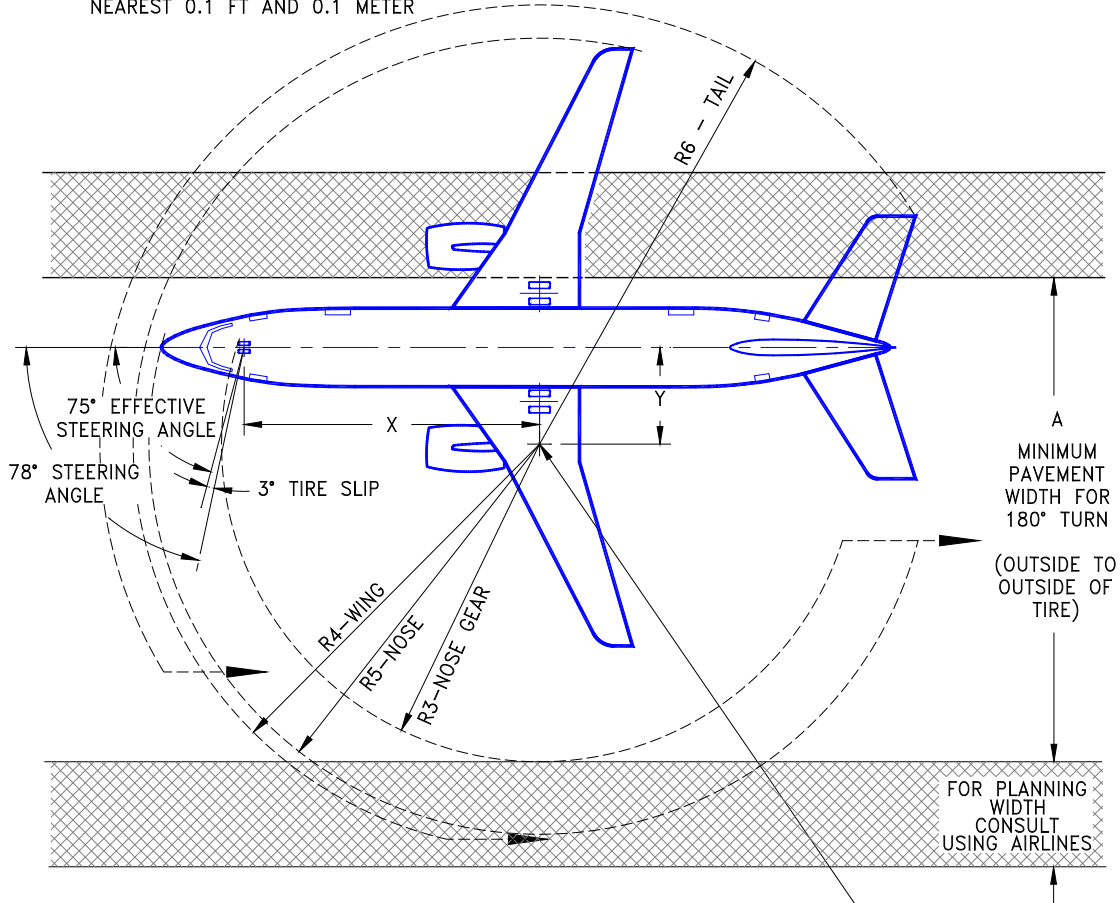

THEORETICAL CENTER OF TURN FOR MINIMUM TURNING RADIUS.
SLOW CONTINUOUS TURNING AT MINIMUM THRUST ON ALL ENGINES.
NO DIFFERENTIAL BRAKING.

AIRPLANE MODEL	EFFECTIVE TURNING ANGLE (DEG)	X		Y		A		R3		R4		R5		R6	
		FT	M	FT	M	FT	M	FT	M	FT	M	FT	M	FT	M
737-300	75	40.8	12.4	10.9	3.3	64.6	19.7	43.2	13.2	60.2	18.4	55.1	16.8	64.0	19.5
737-300 WITH WINGLET	75	40.8	12.4	10.9	3.3	64.6	19.7	43.2	13.2	65.4	19.9	55.1	16.8	64.0	19.5
737-400	75	46.8	14.3	12.5	3.8	72.4	22.1	49.4	15.1	61.8	18.8	61.3	18.7	68.3	20.8
737-500	75	36.3	11.1	9.7	3.0	58.7	17.9	38.5	11.7	59.1	18.0	50.4	15.4	60.6	18.5

4.4 VISIBILITY FROM COCKPIT IN STATIC POSITION: MODEL 737, ALL MODELS

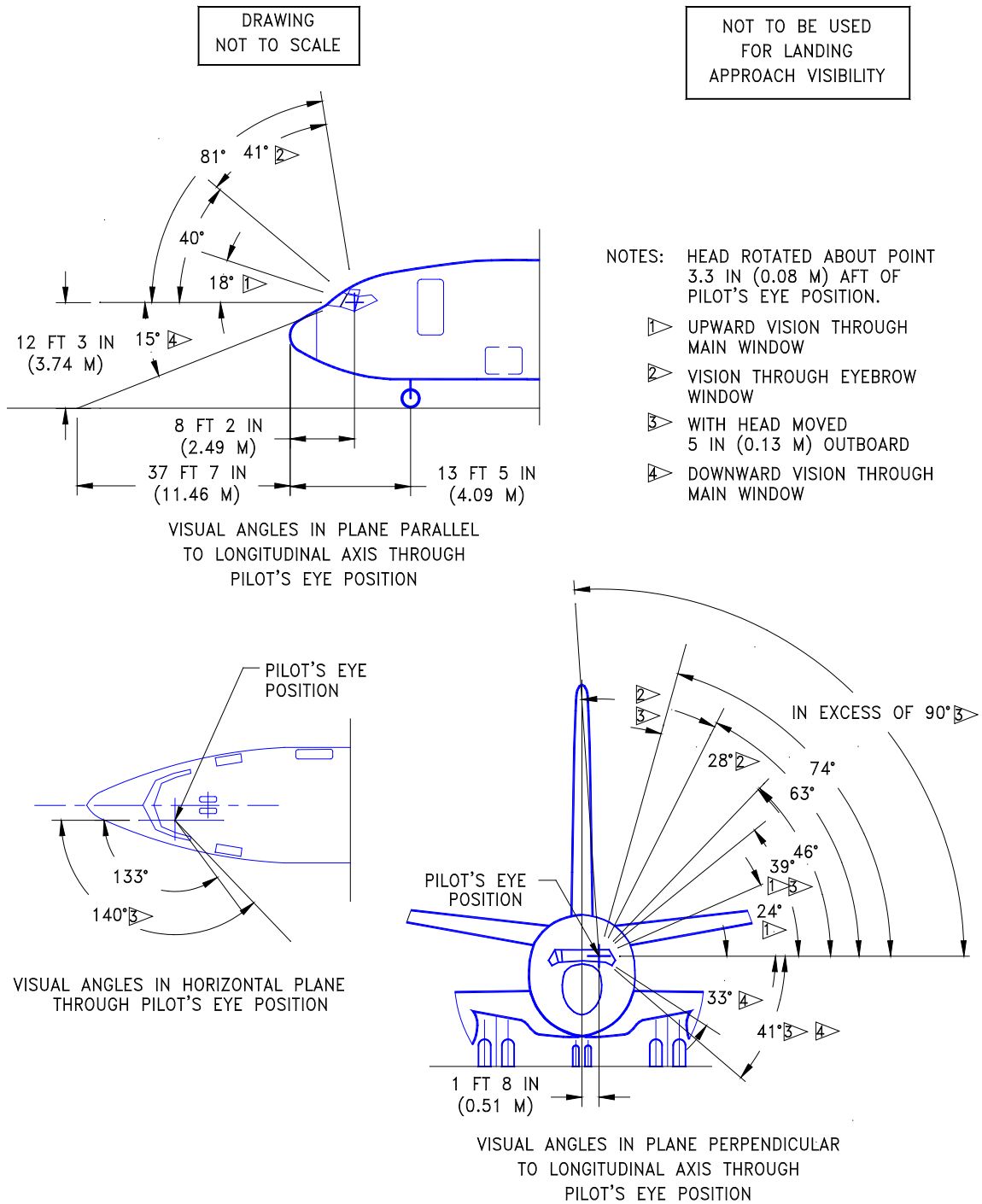

4.5 RUNWAY AND TAXIWAY TURN PATHS

4.5.1 Runway and Taxiway Turn Paths - Runway-to-Taxiway, More Than 90 Degrees, Nose Gear Tracks Centerline: Model 737, All Models

NOTE:
BEFORE DETERMINING THE SIZE OF THE INTERSECTION FILLET, CHECK WITH THE AIRLINES REGARDING THE OPERATING PROCEDURES THAT THEY USE AND THE TYPES OF AIRCRAFT THAT ARE EXPECTED TO SERVE THE AIRPORT.

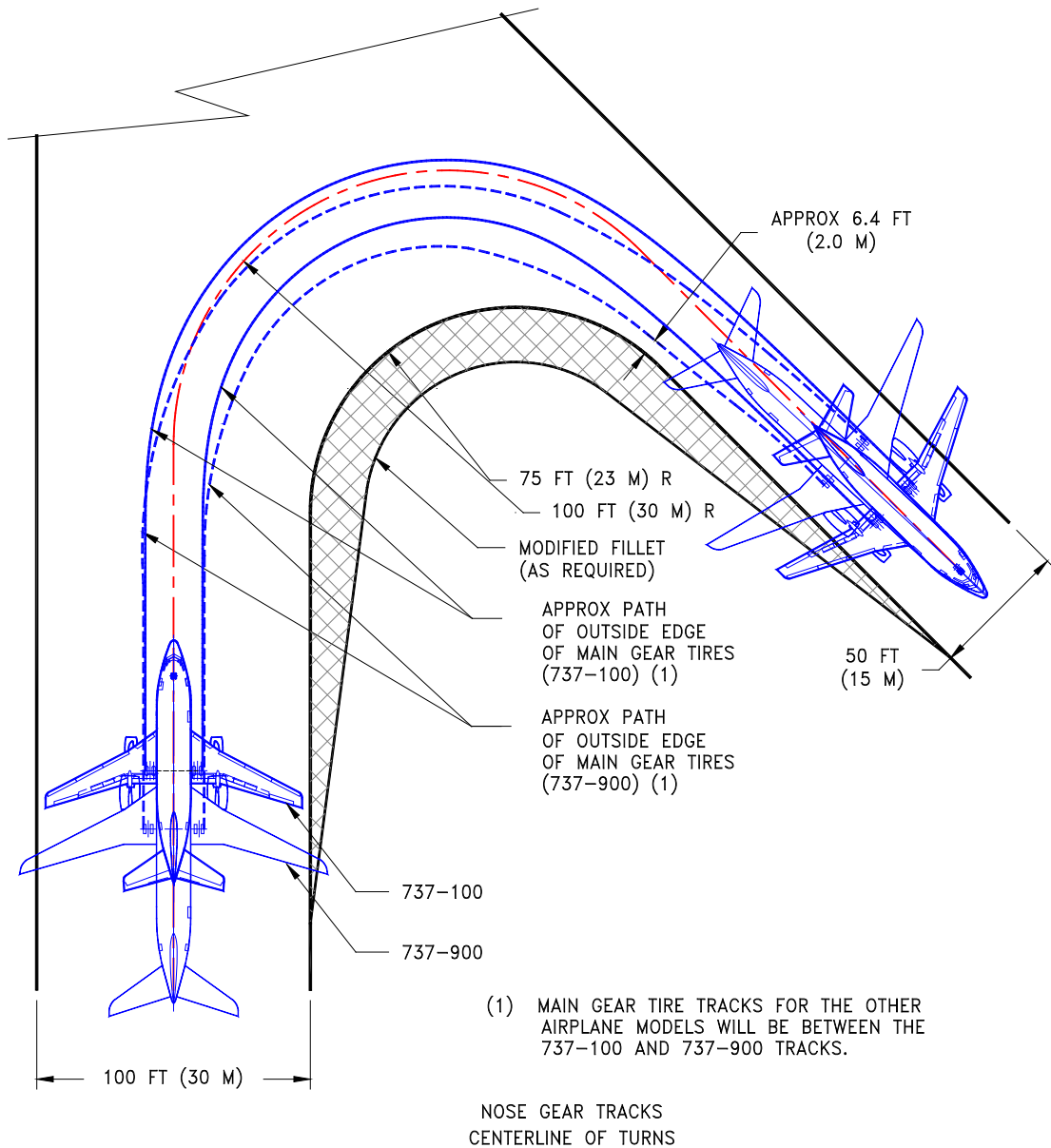

D6-58325-6

REV D

March 2023

4-11

4.5.2 Runway and Taxiway Turn Paths - Runway-to-Taxiway, 90 Degrees, Nose Gear Tracks Centerline: Model 737, All Models

NOTE:
BEFORE DETERMINING THE SIZE OF THE INTERSECTION FILLET, CHECK WITH THE AIRLINES REGARDING THE OPERATING PROCEDURES THAT THEY USE AND THE TYPES OF AIRCRAFT THAT ARE EXPECTED TO SERVE THE AIRPORT.

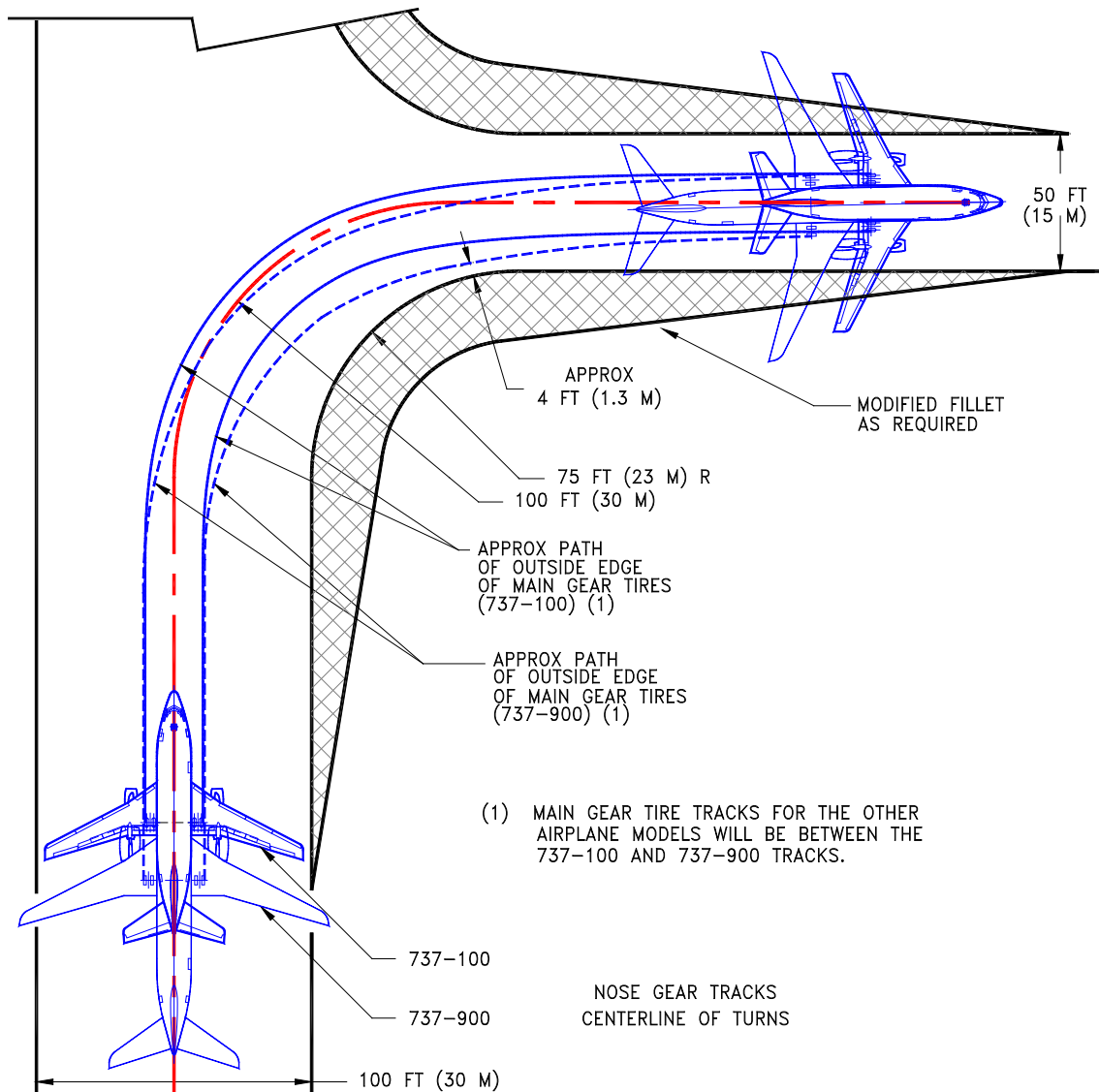

D6-58325-6

REV D

March 2023

4-12

4.5.3 Runway and Taxiway Turn Paths - Taxiway-to-Taxiway, 90 Degrees, Nose Gear Tracks Centerline: Model 737, All Models

NOTE:
BEFORE DETERMINING THE SIZE OF THE INTERSECTION FILLET, CHECK WITH THE AIRLINES REGARDING THE OPERATING PROCEDURES THAT THEY USE AND THE TYPES OF AIRCRAFT THAT ARE EXPECTED TO SERVE THE AIRPORT.

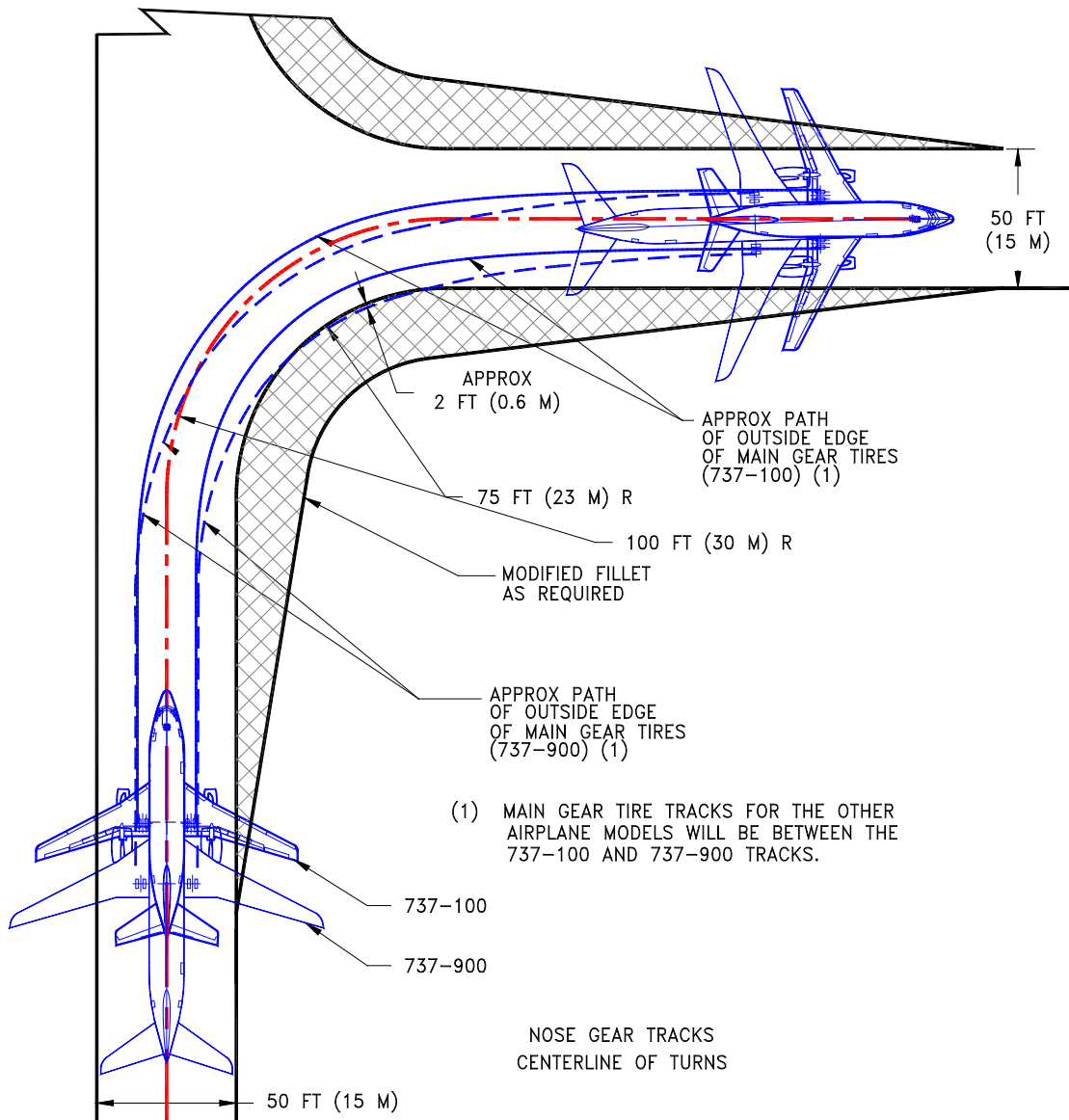

D6-58325-6

REV D

March 2023

4-13

4.5.4 Runway and Taxiway Turn Paths - Taxiway-to-Taxiway, 90 Degrees, Cockpit Tracks Centerline: Model 737, All Models

NOTE:
BEFORE DETERMINING THE SIZE OF THE INTERSECTION FILLET, CHECK WITH THE AIRLINES REGARDING THE OPERATING PROCEDURES THAT THEY USE AND THE TYPES OF AIRCRAFT THAT ARE EXPECTED TO SERVE THE AIRPORT.

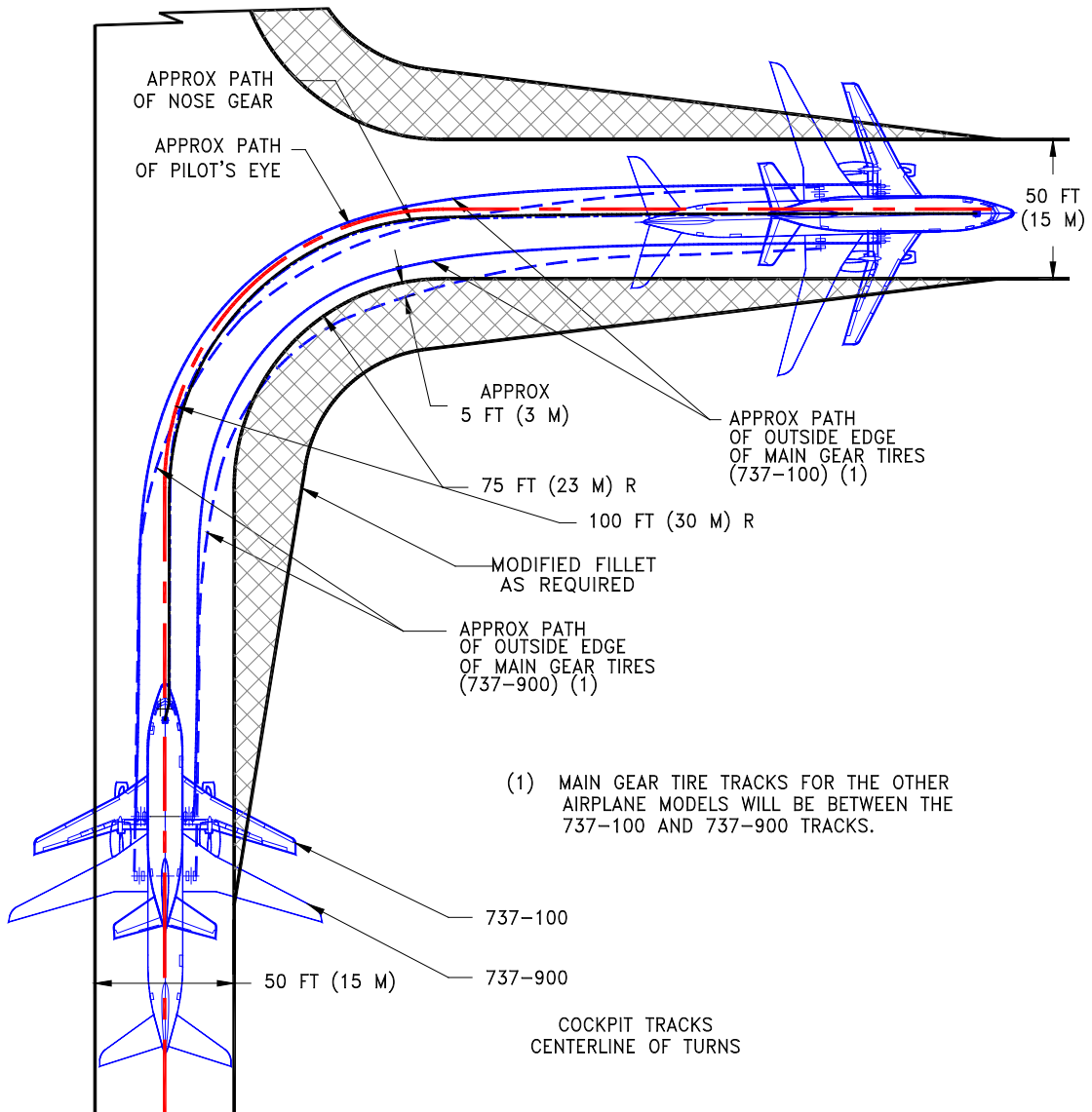

D6-58325-6

REV D

March 2023

4-14

4.6 RUNWAY HOLDING BAY: MODEL 737, ALL MODELS

NOTE:
BEFORE DETERMINING THE SIZE OF THE PAVEMENT AND SHOULDER, CHECK WITH THE AIRLINES REGARDING THE OPERATING PROCEDURES THAT THEY USE AND THE AIRCRAFT TYPES THAT ARE EXPECTED TO SERVE THE AIRPORT.

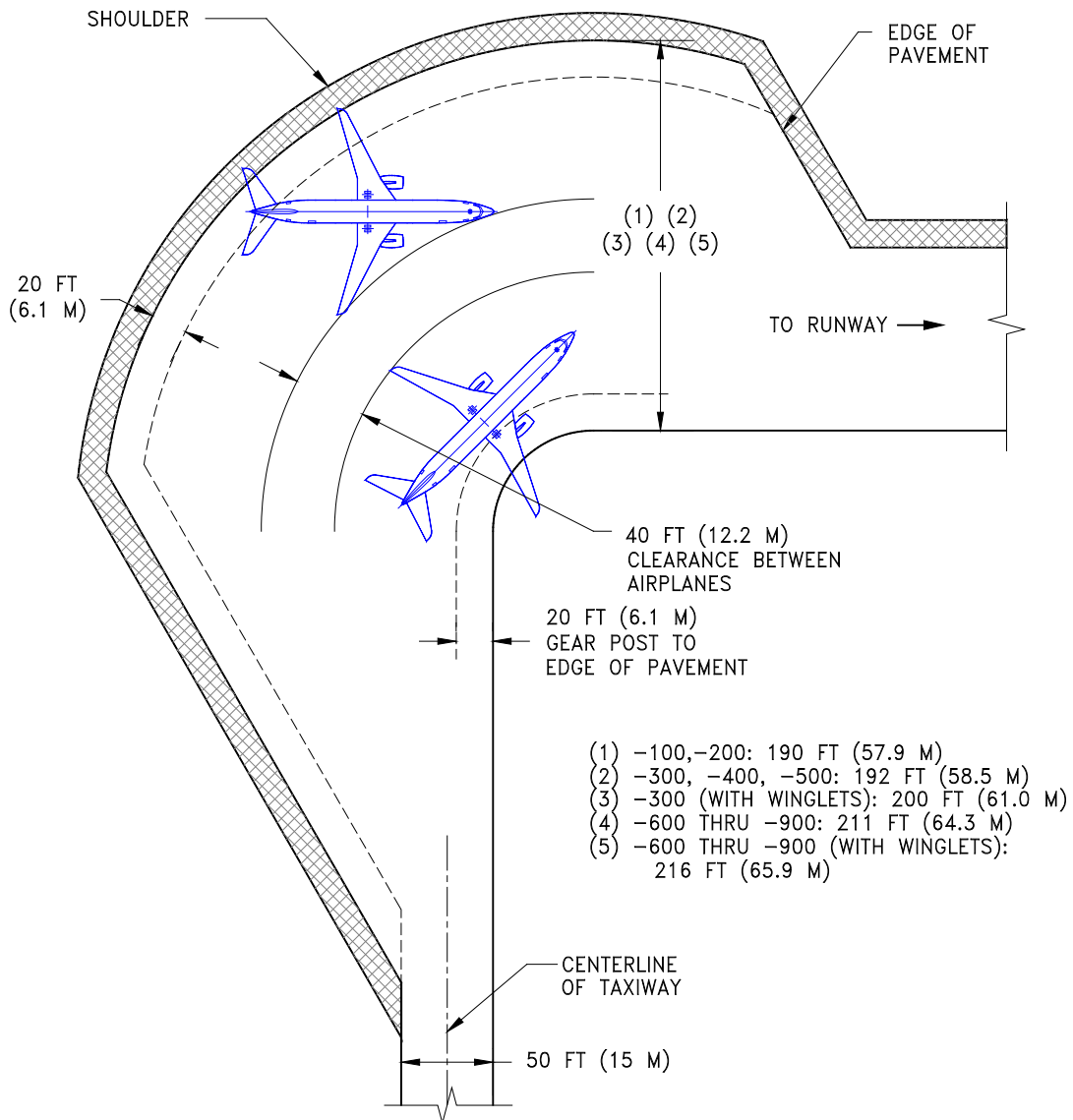

D6-58325-6

REV D

March 2023

4-15

5.0 TERMINAL SERVICING

During turnaround at the terminal, certain services must be performed on the aircraft, usually within a given time, to meet flight schedules. This section shows service vehicle arrangements, schedules, locations of service points, and typical service requirements. The data presented in this section reflect ideal conditions for a single airplane. Service requirements may vary according to airplane condition and airline procedure.

Section 5.1 shows typical arrangements of ground support equipment during turnaround. As noted, if the auxiliary power unit (APU) is used, the electrical, air start, and air-conditioning service vehicles would not be required. Passenger loading bridges or portable passenger stairs could be used to load or unload passengers.

Sections 5.2 and 5.3 show typical service times at the terminal. These charts give typical schedules for performing service on the airplane within a given time. Service times could be rearranged to suit availability of personnel, airplane configuration, and degree of service required.

Section 5.4 shows the locations of ground service connections in graphic and in tabular forms. Typical capacities and service requirements are shown in the tables. Services with requirements that vary with conditions are described in subsequent sections.

Section 5.5 shows typical sea level air pressure and flow requirements for starting different engines. The curves are based on an engine start time of 90 seconds.

Section 5.6 shows pneumatic requirements for heating and cooling (air conditioning) using high pressure air to run the air cycle machine. The curves show airflow requirements to heat or cool the airplane within a given time and ambient conditions. Maximum allowable pressure and temperature for air cycle machine operation are 60 psia and 450°F, respectively.

Section 5.7 shows pneumatic requirements for heating and cooling the airplane, using low pressure conditioned air. This conditioned air is supplied through an 8-in ground air connection (GAC) directly to the passenger cabin, bypassing the air cycle machines.

Section 5.8 shows ground towing requirements for various ground surface conditions.

5.1 AIRPLANE SERVICING ARRANGEMENT - TYPICAL TURNAROUND

5.1.1 Airplane Servicing Arrangement - Typical Turnaround: Model 737-100

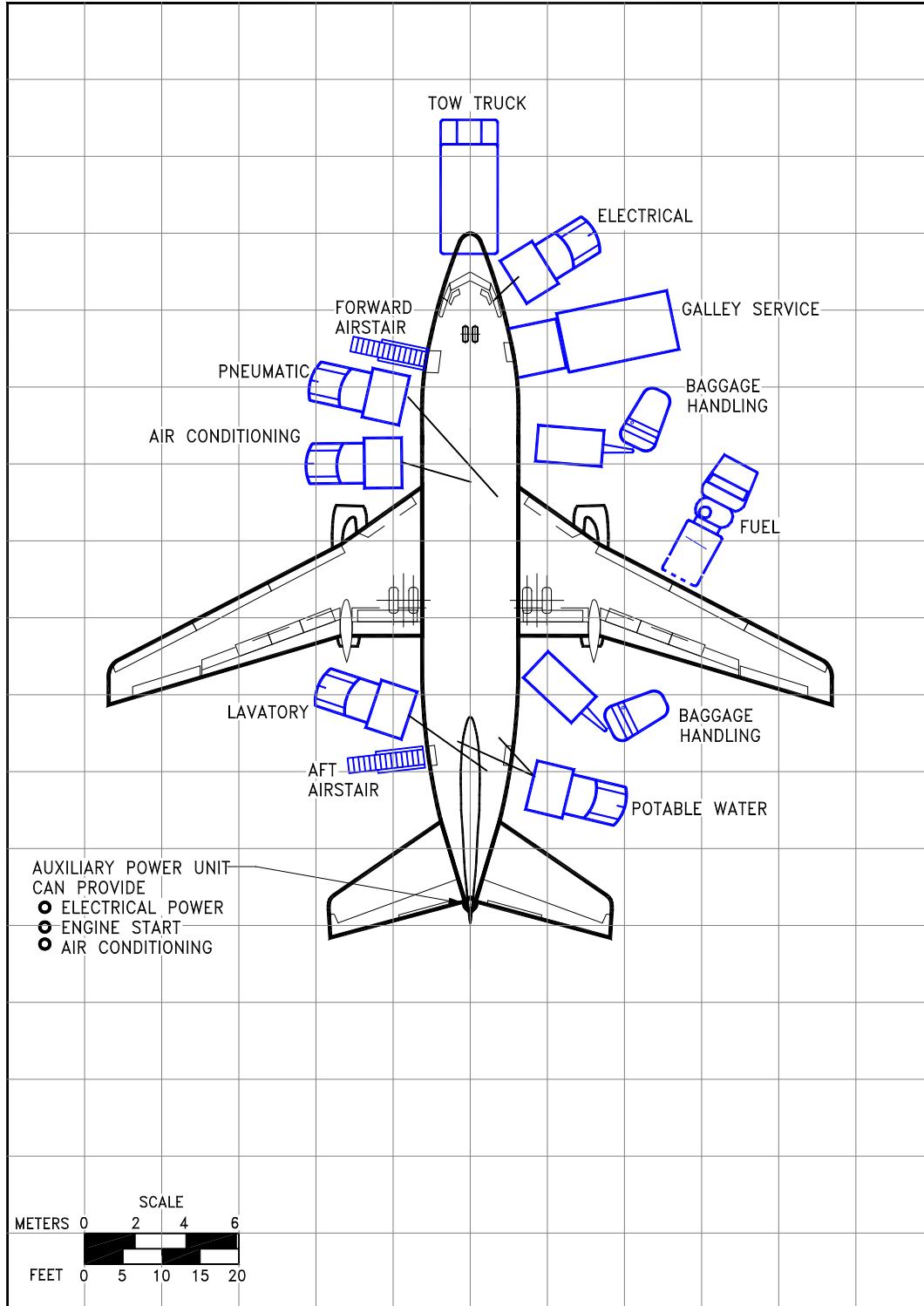

D6-58325-6

REV D

March 2023

5-2

5.1.2 Airplane Servicing Arrangement - Typical Turnaround: Model 737-200

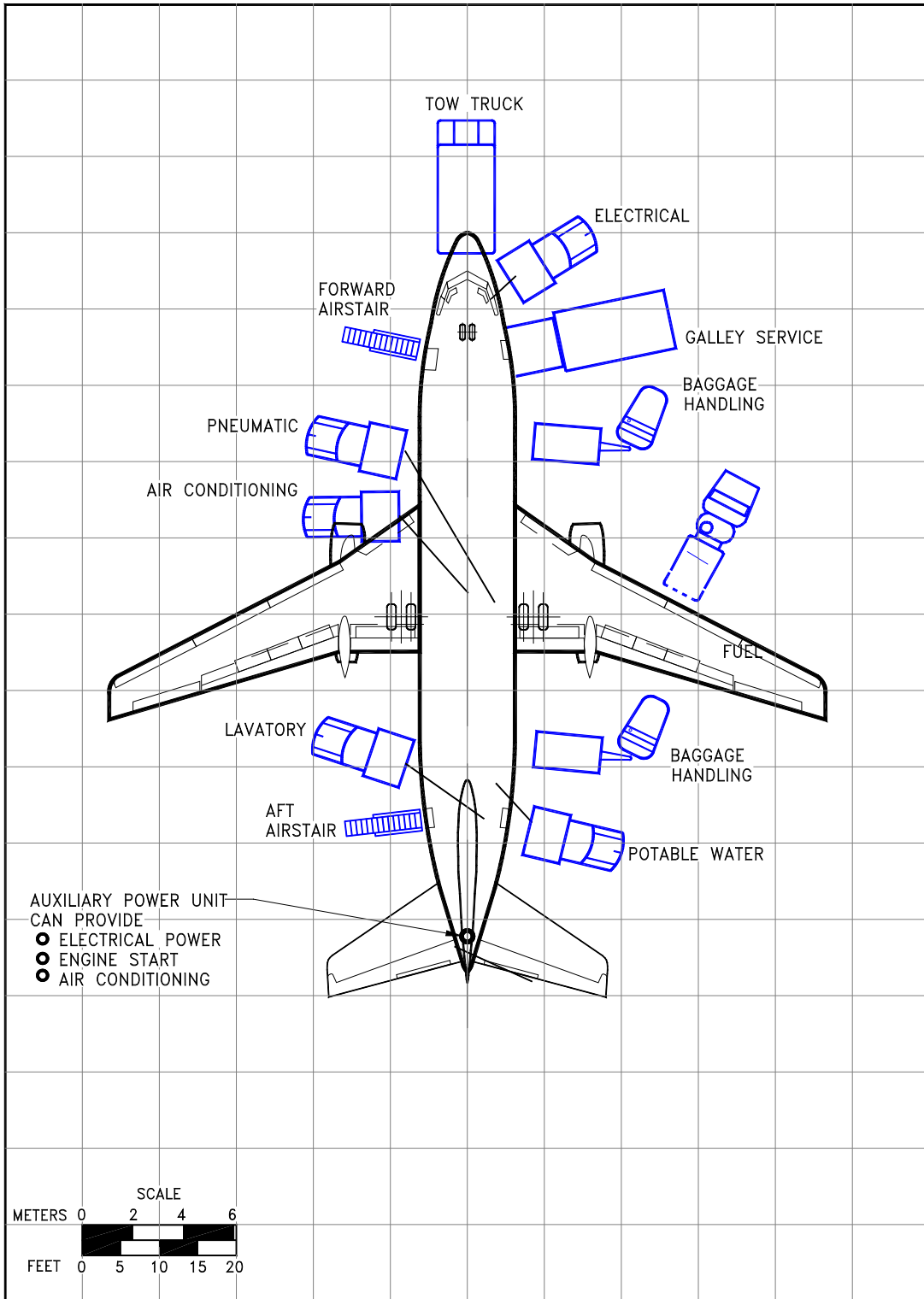

D6-58325-6

REV D

March 2023

5-3

5.1.3 Airplane Servicing Arrangement - Typical Turnaround: Model 737-300

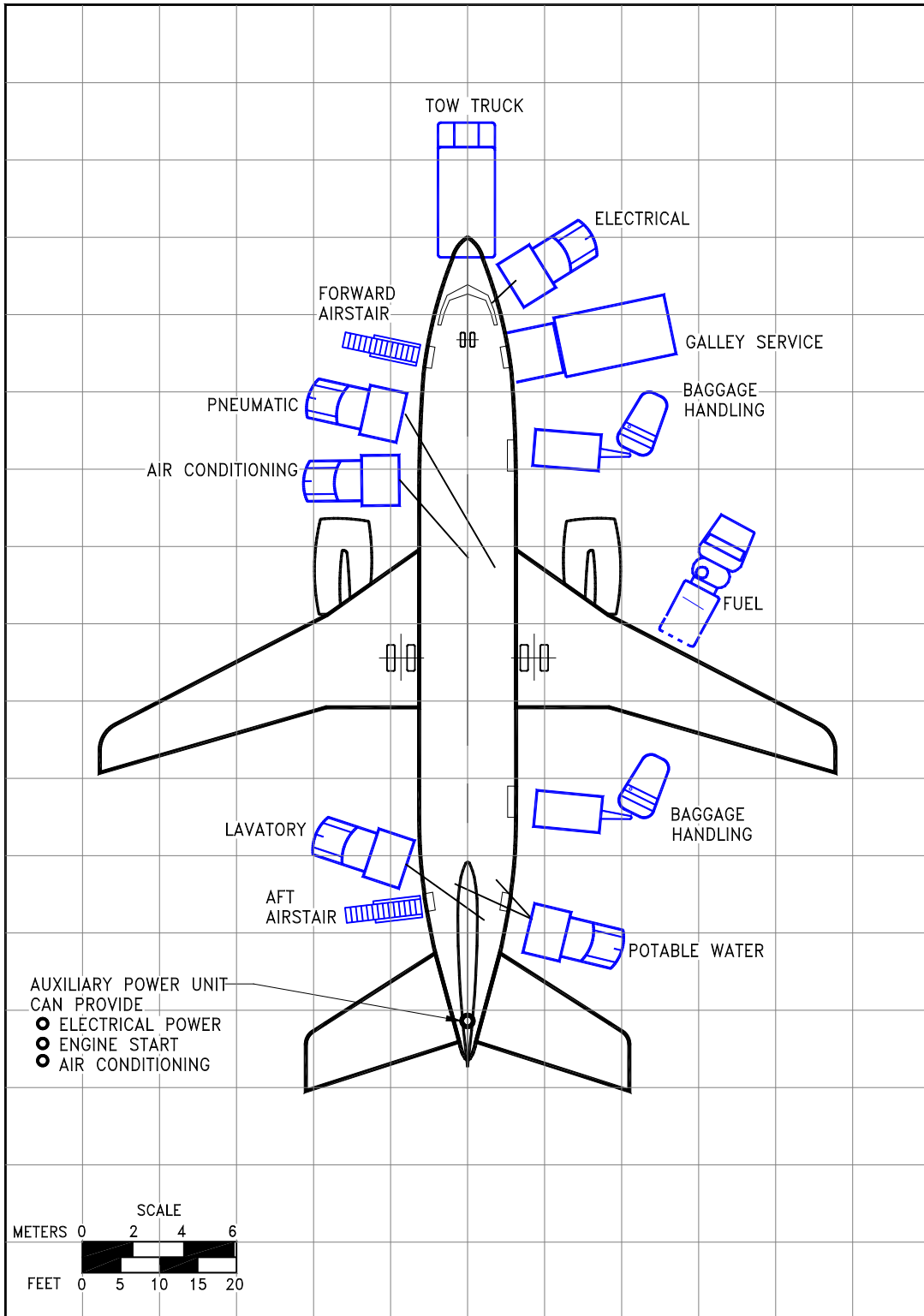

D6-58325-6

5.1.4 Airplane Servicing Arrangement - Typical Turnaround: Model 737-400

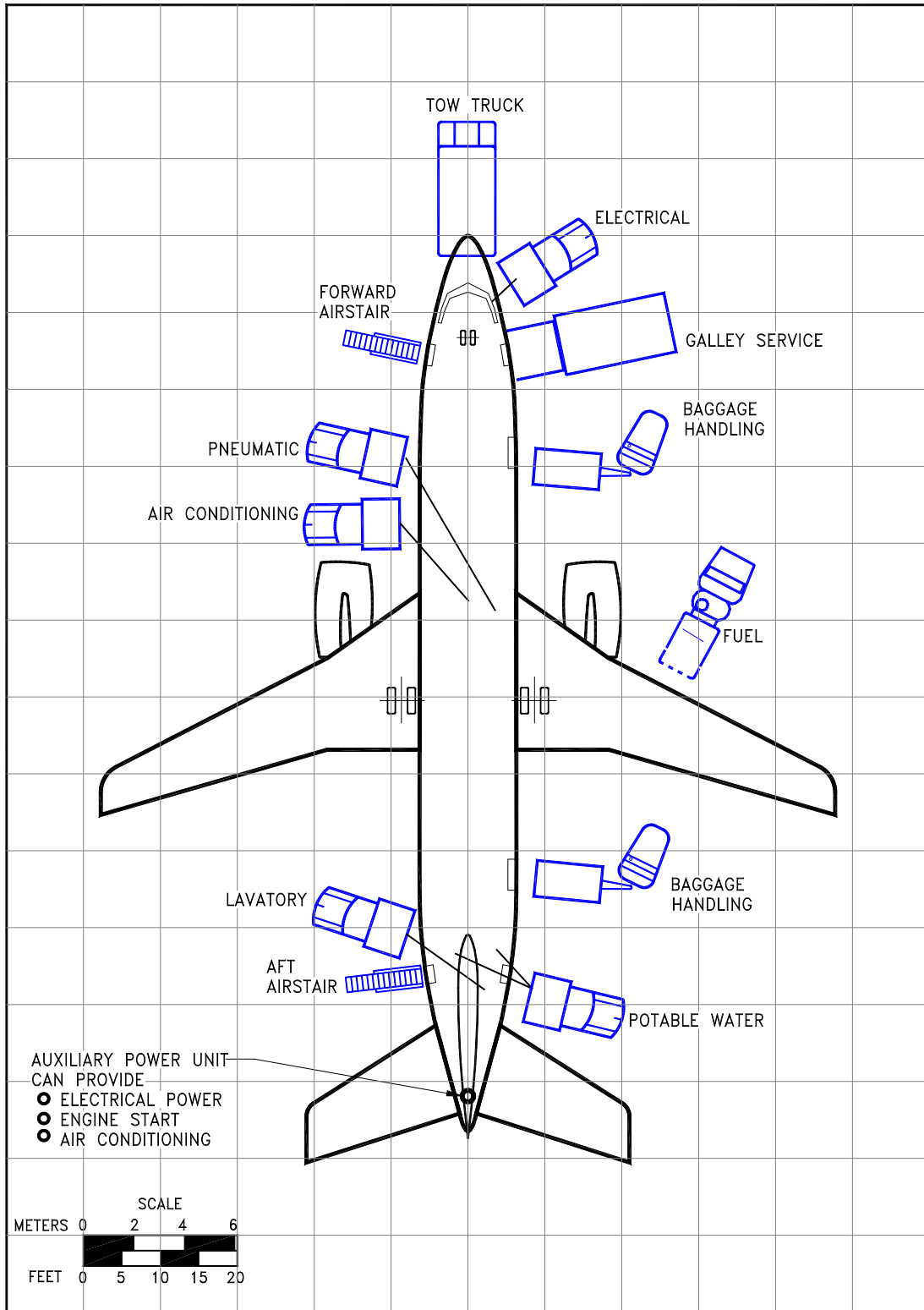

D6-58325-6

5.1.5 Airplane Servicing Arrangement - Typical Turnaround: Model 737-500

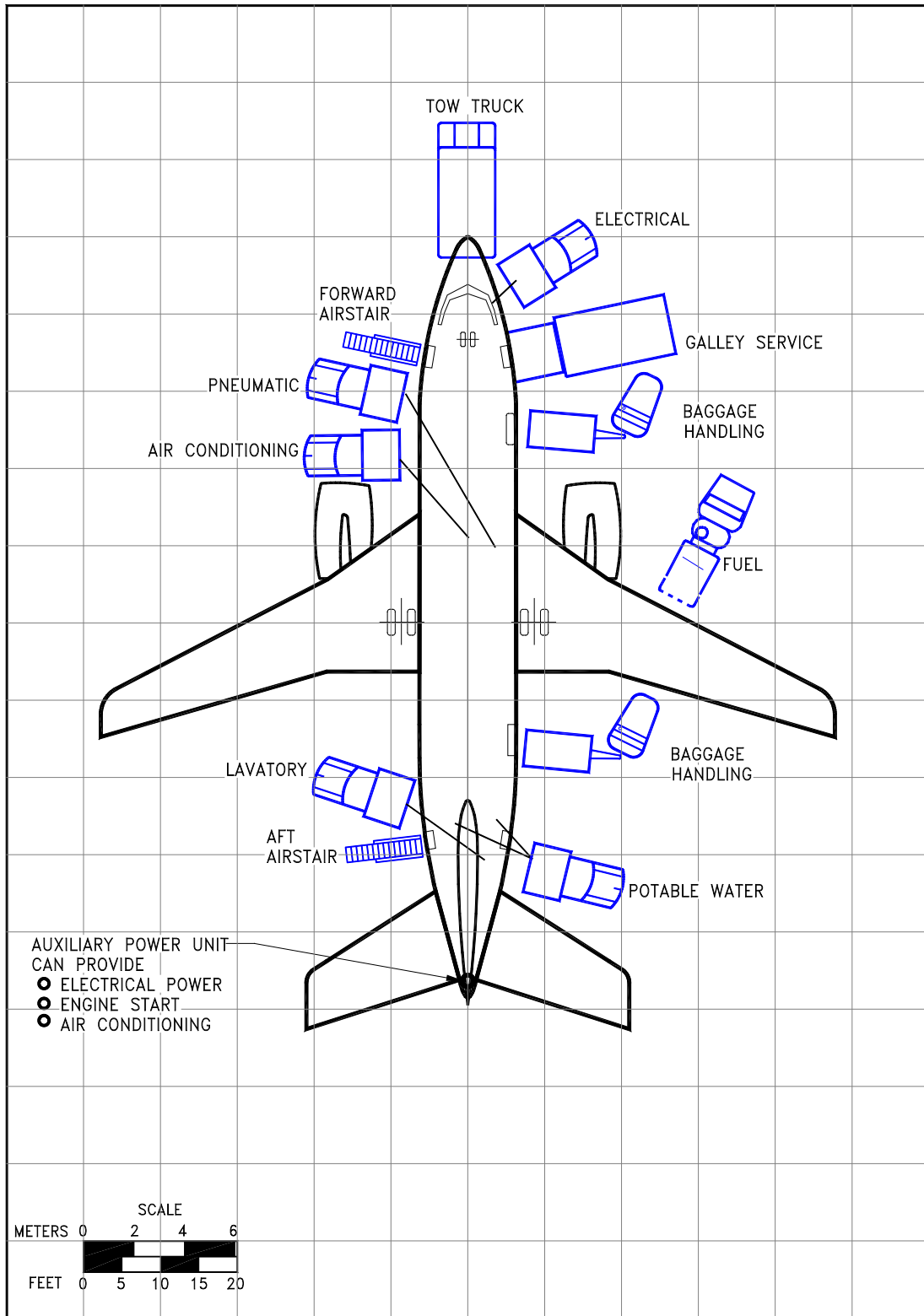

D6-58325-6

5.2 TERMINAL OPERATIONS - TURNAROUND STATION

5.2.1 Terminal Operations - Turnaround Station: Model 737-100, -200

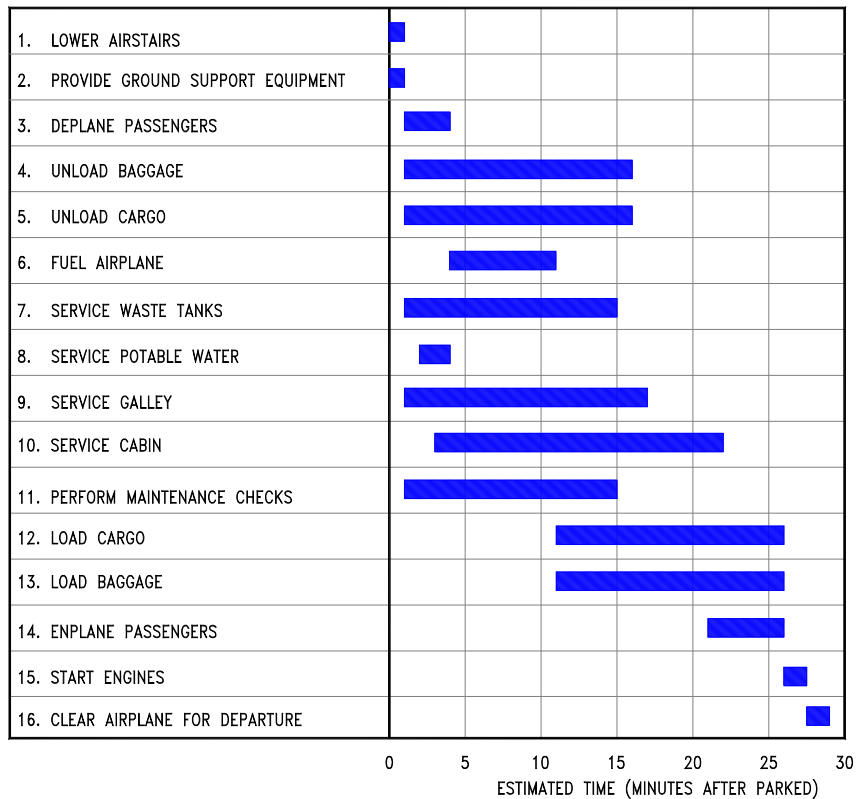

NOTES:

1. ESTIMATES BASED ON MIXED-CLASS CONFIGURATION, 65% LOAD FACTOR
2. IT IS ASSUMED THAT ALL EQUIPMENT FUNCTION PROPERLY AND THAT NO ABNORMAL WEATHER CONDITIONS EXIST.
3. TOTAL TIME ON THE RAMP IS 30 MINUTES
4. BOTH FORWARD AND AFT DOORS ARE USED
5. 100% PASSENGER EXCHANGE
6. THIS DATA IS PROVIDED TO ILLUSTRATE THE GENERAL SCOPE AND TYPES OF TASKS INVOLVED IN TERMINAL OPERATIONS. VARYING AIRLINE PRACTICES AND OPERATING CIRCUMSTANCES THROUGHOUT THE WORLD WILL RESULT IN DIFFERENT SEQUENCES AND TIME INTERVALS TO ACCOMPLISH THE TASKS SHOWN.
7. GROUND OPERATIONS REQUIREMENTS SHOULD BE COORDINATED WITH USING AIRLINES PRIOR TO RAMP PLANNING

5.2.2 Terminal Operations - Turnaround Station – Passenger/Cargo: Model 737-200C

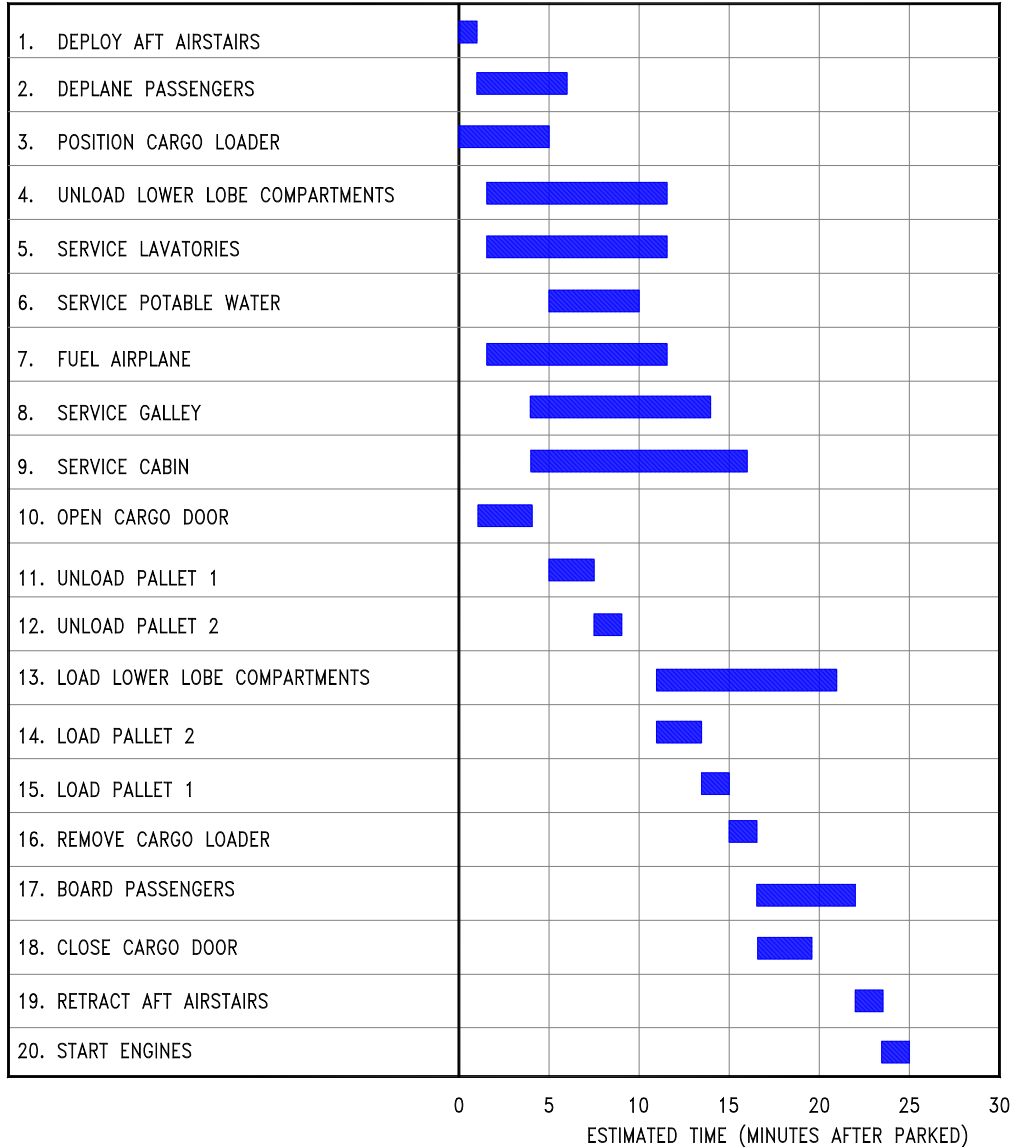

NOTES:

- ESTIMATES BASED ON 76-PASSENGER/TWO MAIN DECK PALLET CONFIGURATION
100% LOAD FACTOR AND FULL PASSENGER/BAGGAGE EXCHANGE
- IT IS ASSUMED THAT ALL EQUIPMENT FUNCTION PROPERLY AND THAT NO ABNORMAL WEATHER CONDITIONS EXIST.
- TOTAL TIME ON THE RAMP IS 25 MINUTES
- THIS DATA IS PROVIDED TO ILLUSTRATE THE GENERAL SCOPE AND TYPES OF TASKS INVOLVED IN TERMINAL OPERATIONS. VARYING AIRLINE PRACTICES AND OPERATING CIRCUMSTANCES THROUGHOUT THE WORLD WILL RESULT IN DIFFERENT SEQUENCES AND TIME INTERVALS TO ACCOMPLISH THE TASKS SHOWN.
- GROUND OPERATIONS REQUIREMENTS SHOULD BE COORDINATED WITH USING AIRLINES PRIOR TO RAMP PLANNING

5.2.3 Terminal Operations - Turnaround Station – All Cargo: Model 737-200C

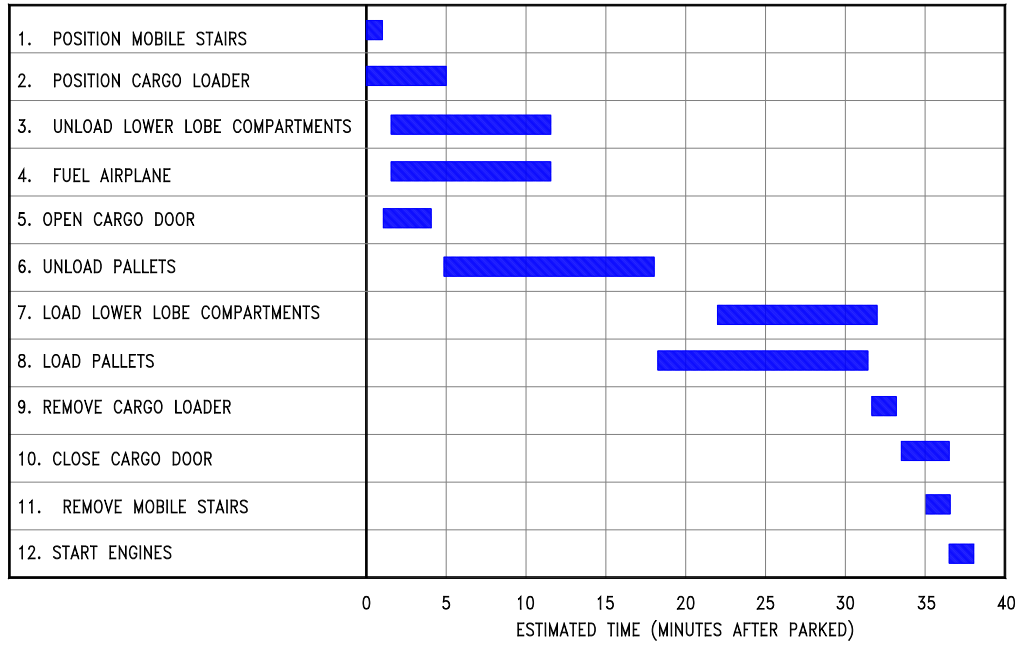

NOTES:

1. IT IS ASSUMED THAT ALL EQUIPMENT FUNCTION PROPERLY AND THAT NO ABNORMAL WEATHER CONDITIONS EXIST.
2. THIS DATA IS PROVIDED TO ILLUSTRATE THE GENERAL SCOPE AND TYPES OF TASKS INVOLVED IN TERMINAL OPERATIONS. VARYING AIRLINE PRACTICES AND OPERATING CIRCUMSTANCES THROUGHOUT THE WORLD WILL RESULT IN DIFFERENT SEQUENCES AND TIME INTERVALS TO ACCOMPLISH THE TASKS SHOWN.
3. GROUND OPERATIONS REQUIREMENTS SHOULD BE COORDINATED WITH USING AIRLINES PRIOR TO RAMP PLANNING

5.2.4 Terminal Operations – Turnaround Station: Model 737-300, -400, -500

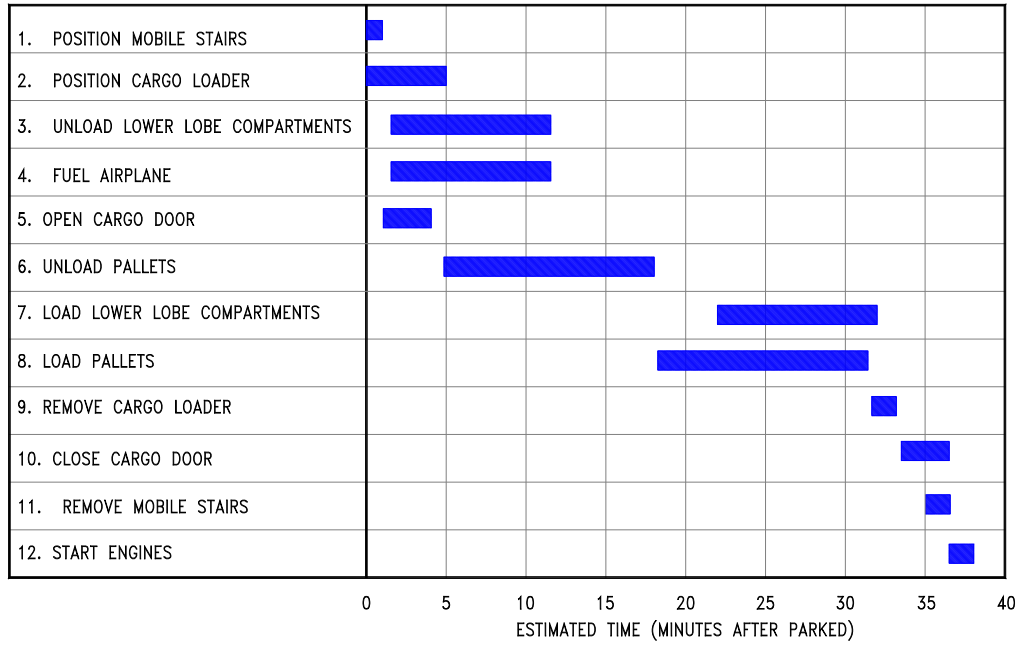

NOTES:

1. IT IS ASSUMED THAT ALL EQUIPMENT FUNCTION PROPERLY AND THAT NO ABNORMAL WEATHER CONDITIONS EXIST.
2. THIS DATA IS PROVIDED TO ILLUSTRATE THE GENERAL SCOPE AND TYPES OF TASKS INVOLVED IN TERMINAL OPERATIONS. VARYING AIRLINE PRACTICES AND OPERATING CIRCUMSTANCES THROUGHOUT THE WORLD WILL RESULT IN DIFFERENT SEQUENCES AND TIME INTERVALS TO ACCOMPLISH THE TASKS SHOWN.
3. GROUND OPERATIONS REQUIREMENTS SHOULD BE COORDINATED WITH USING AIRLINES PRIOR TO RAMP PLANNING

5.3 TERMINAL OPERATIONS - EN ROUTE STATION

5.3.1 Terminal Operations - En Route Station: Model 737-100, -200, -300, -400, -500

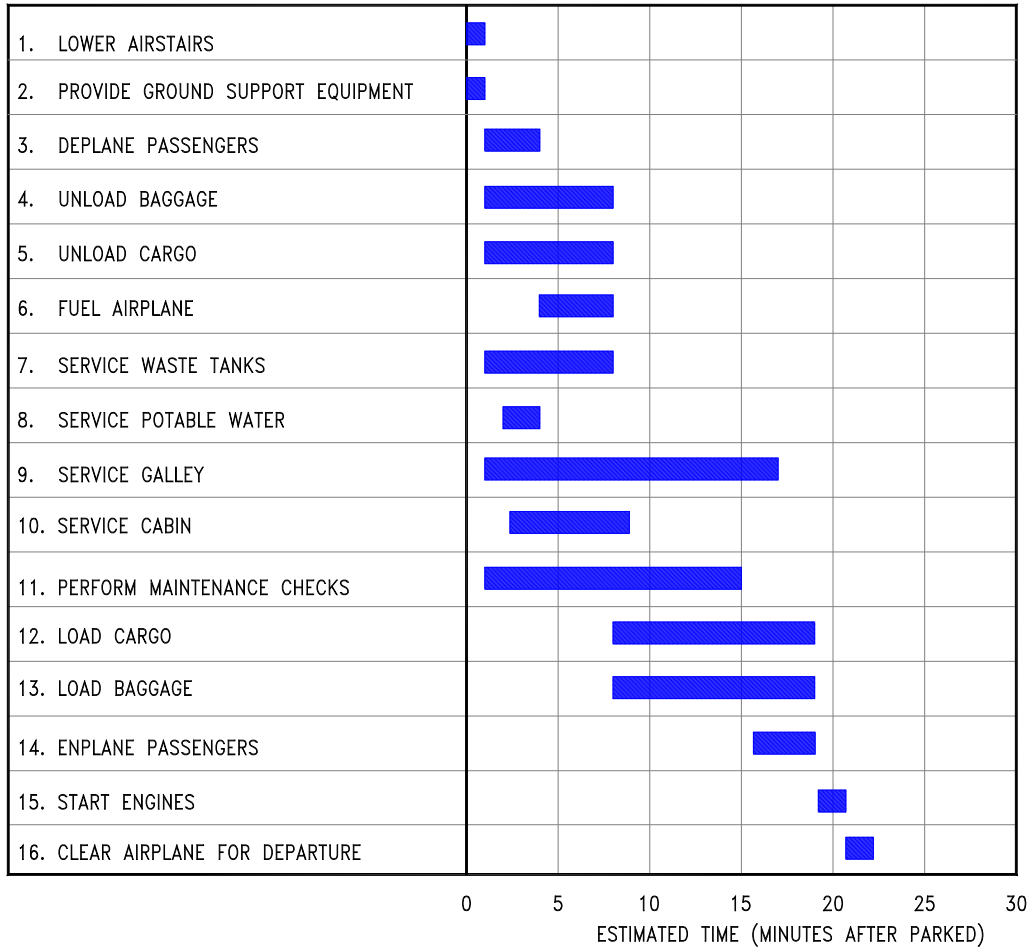

NOTES:

1. ESTIMATES BASED ON MIXED-CLASS CONFIGURATION, 65% LOAD FACTOR
2. IT IS ASSUMED THAT ALL EQUIPMENT FUNCTION PROPERLY AND THAT NO ABNORMAL WEATHER CONDITIONS EXIST.
3. TOTAL TIME ON THE RAMP IS 25 MINUTES
4. BOTH FORWARD AND AFT DOORS ARE USED
5. 75% PASSENGER EXCHANGE
6. THIS DATA IS PROVIDED TO ILLUSTRATE THE GENERAL SCOPE AND TYPES OF TASKS INVOLVED IN TERMINAL OPERATIONS. VARYING AIRLINE PRACTICES AND OPERATING CIRCUMSTANCES THROUGHOUT THE WORLD WILL RESULT IN DIFFERENT SEQUENCES AND TIME INTERVALS TO ACCOMPLISH THE TASKS SHOWN.
7. GROUND OPERATIONS REQUIREMENTS SHOULD BE COORDINATED WITH USING AIRLINES PRIOR TO RAMP PLANNING

5.4 GROUND SERVICING CONNECTIONS

5.4.1 Ground Service Connections: Model 737-100

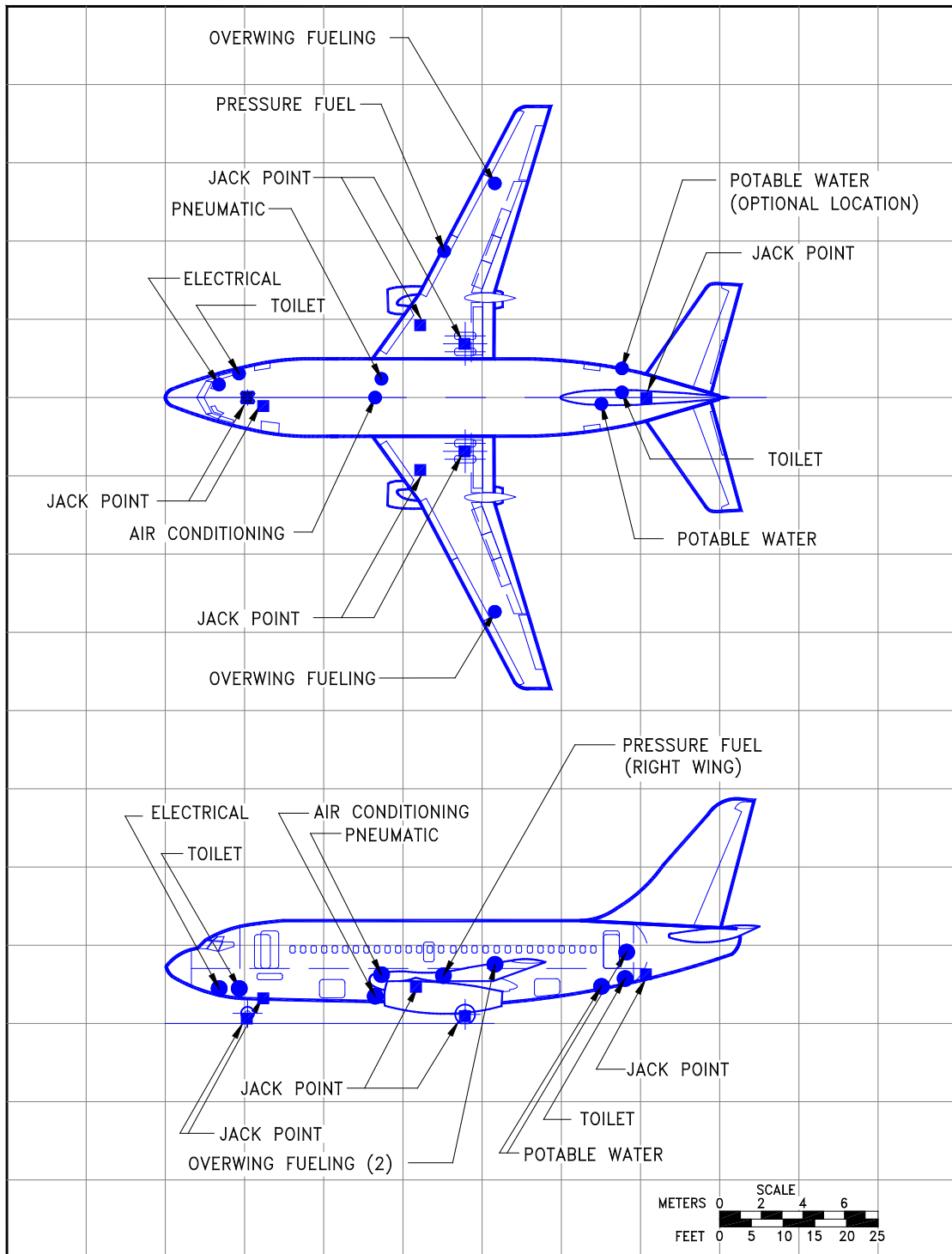

D6-58325-6

REV D

March 2023

5-12

5.4.2 Ground Service Connections: Model 737-200

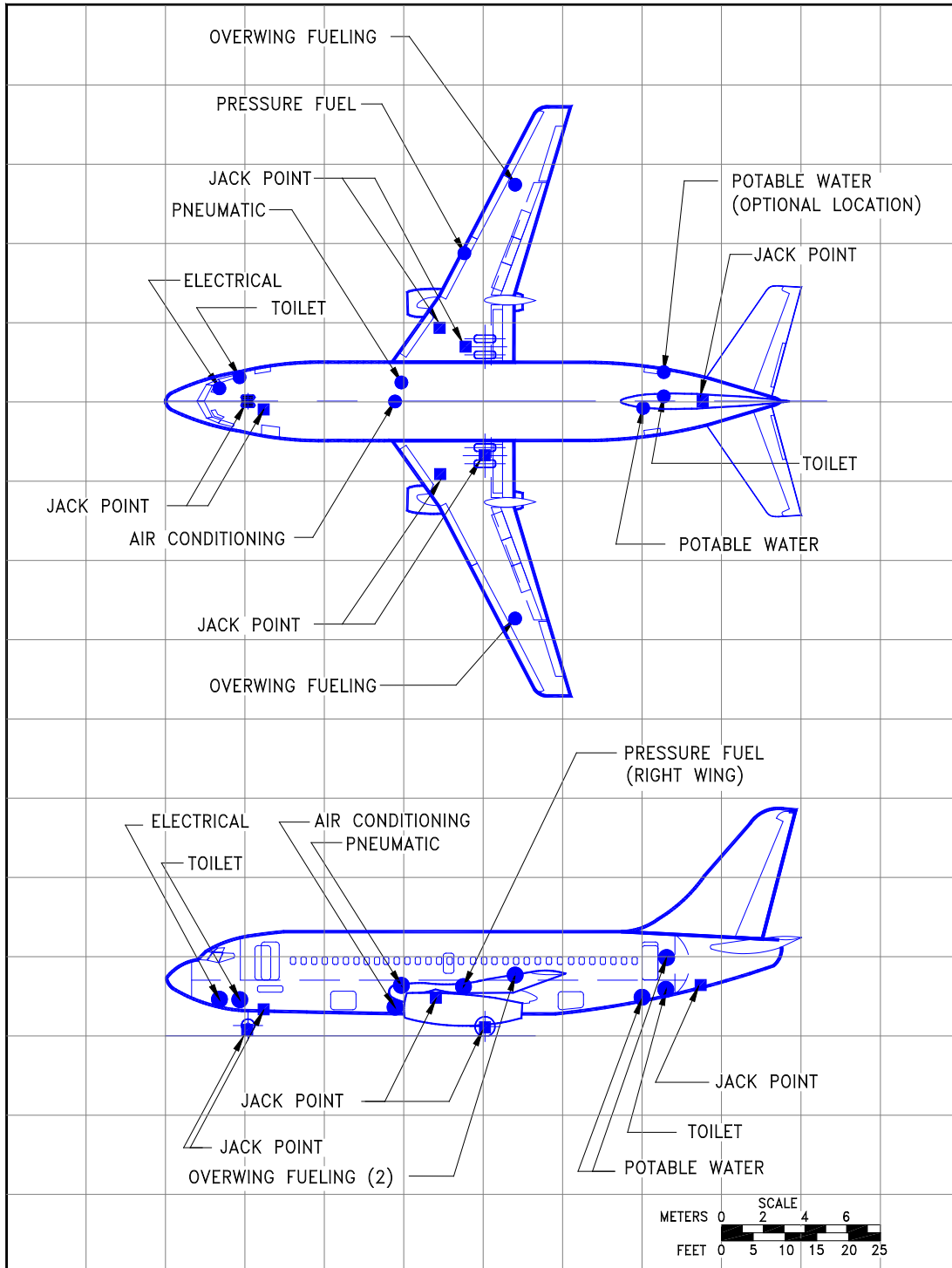

D6-58325-6

REV D

March 2023

5-13

5.4.3 Ground Service Connections: Model 737-300

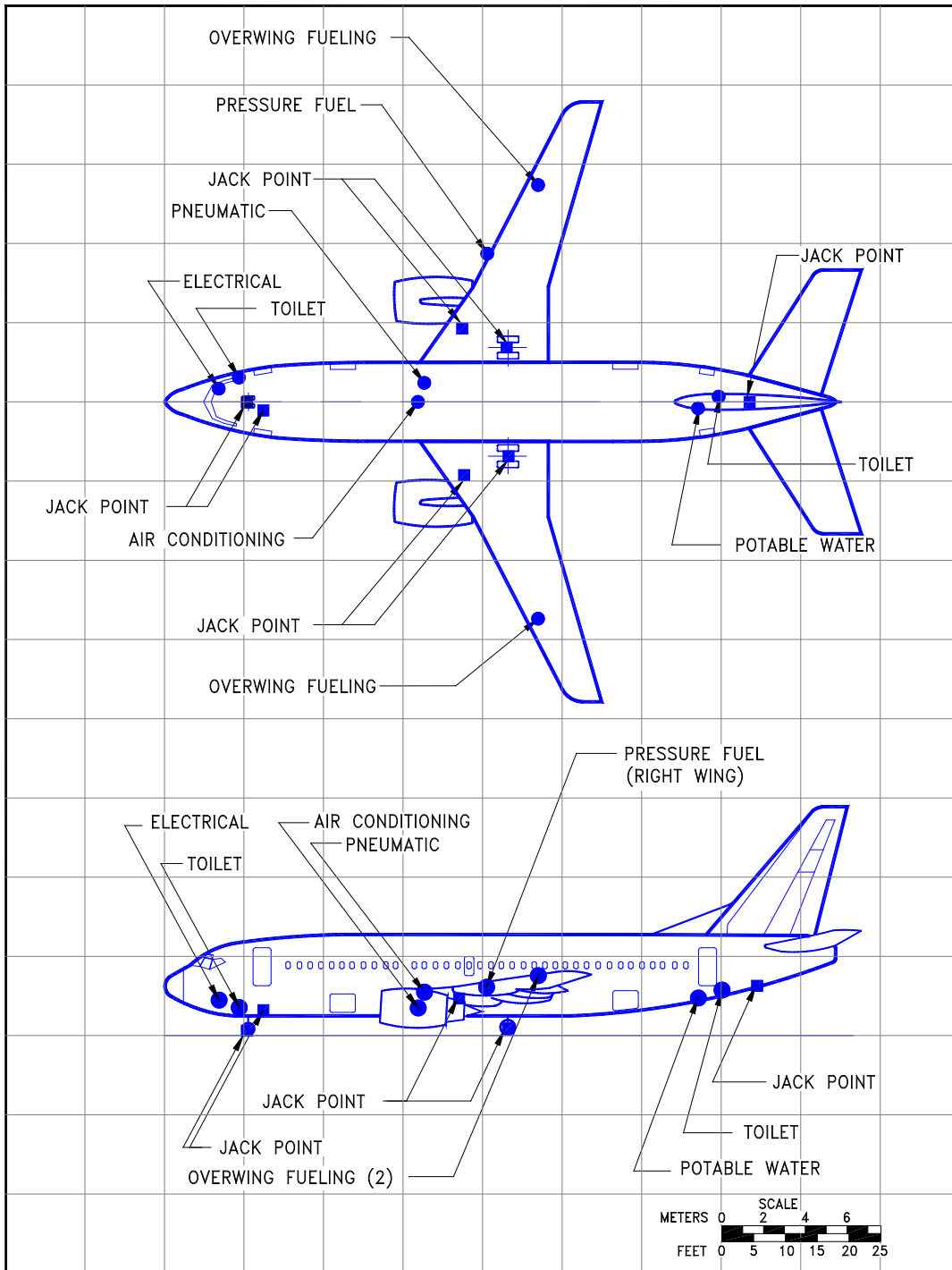

D6-58325-6

5.4.4 Ground Service Connections: Model 737-400

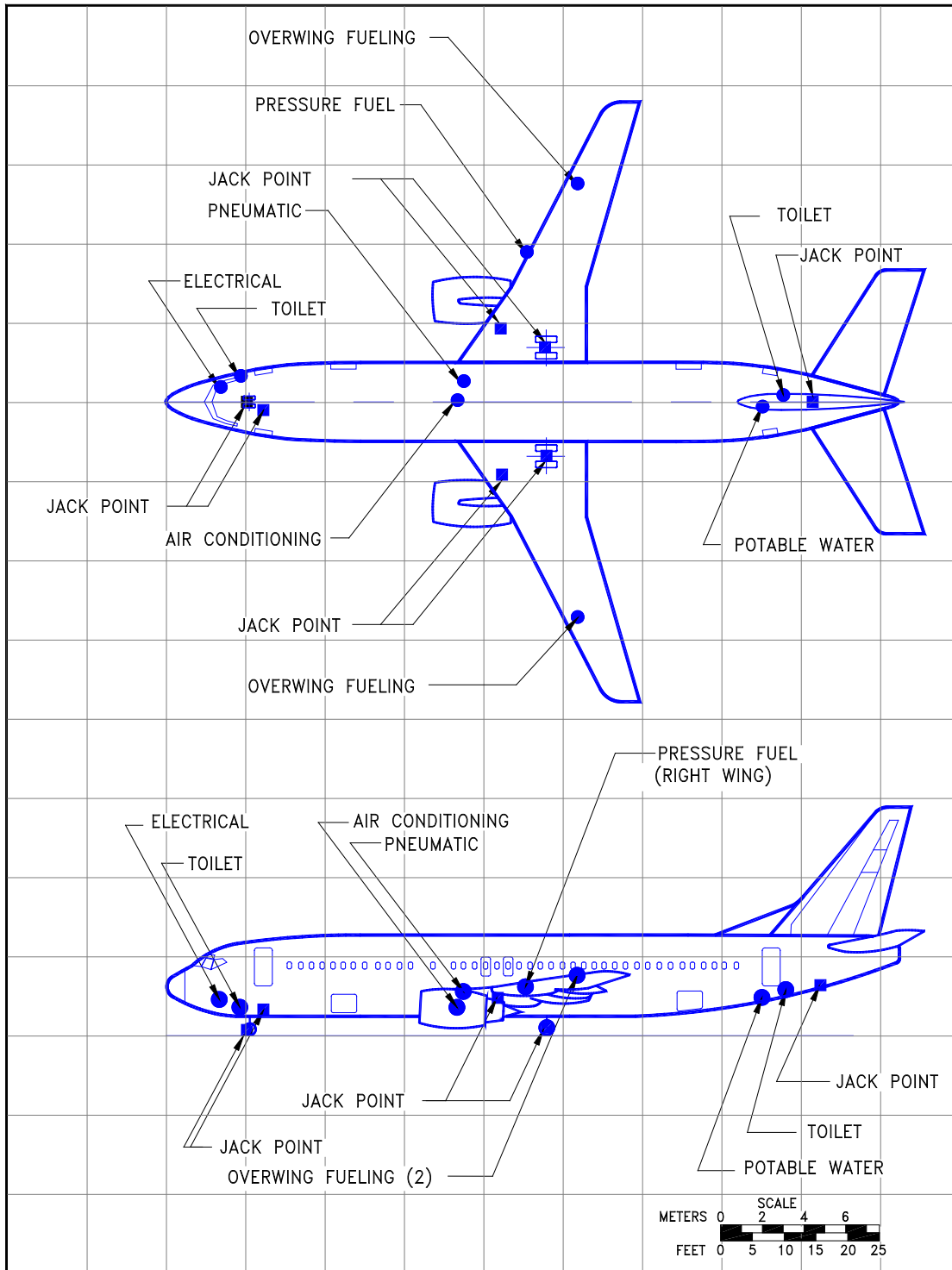

D6-58325-6

5.4.5 Ground Service Connections: Model 737-500

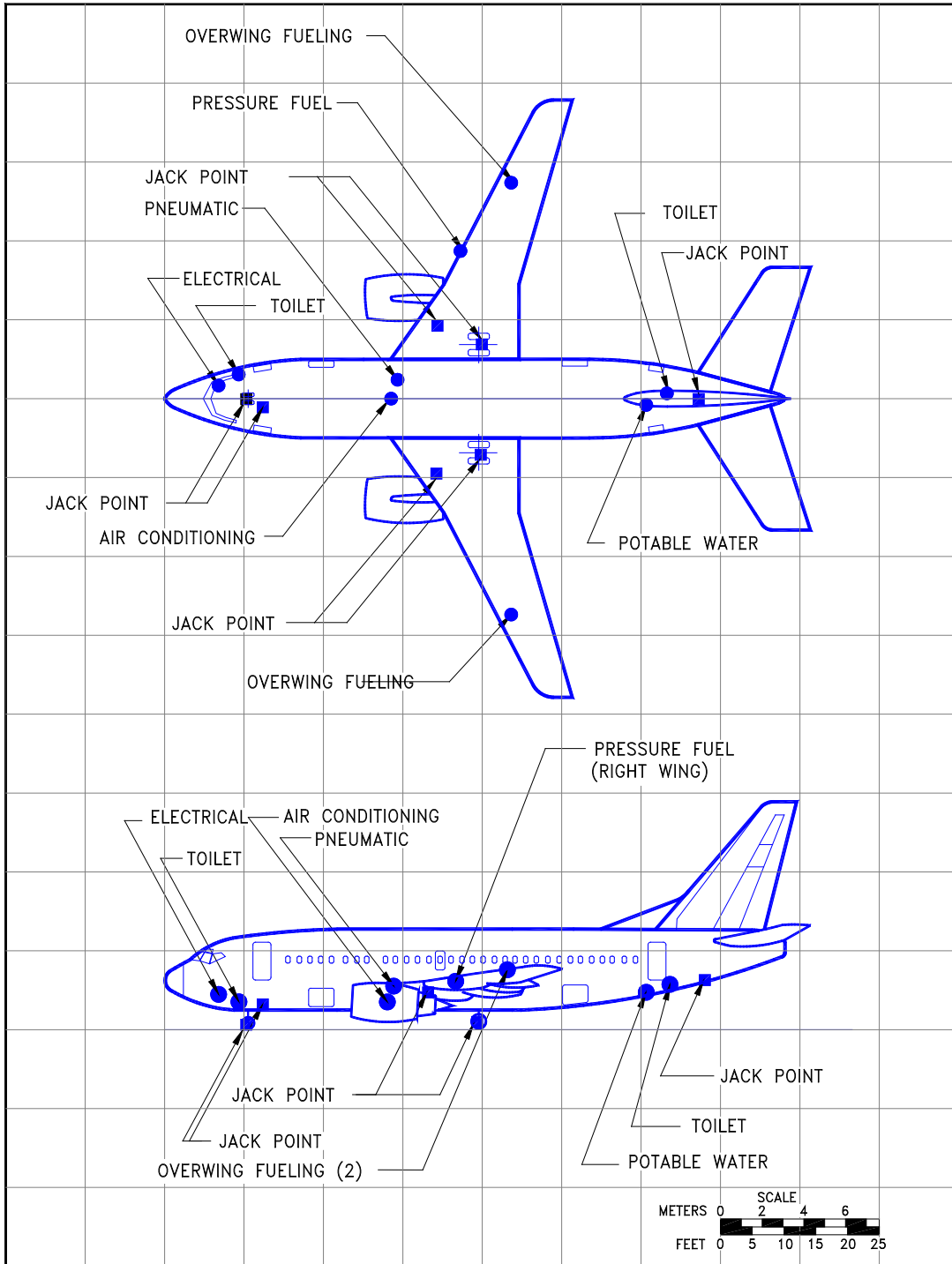

D6-58325-6

5.4.6 Ground Servicing Connections and Capacities: Model 737, All Models

SYSTEM	MODEL	DISTANCE AFT OF NOSE		DISTANCE FROM AIRPLANE CENTERLINE				MAX HEIGHT ABOVE GROUND	
		FT-IN	M	LH SIDE		RH SIDE		FT-IN	M
				FT-IN	M	FT-IN	M		
CONDITIONED AIR ONE 8-IN (20.3 CM) PORT	737-100	33 - 2	10.1	0	0	0	0	3-3	1.0
	737-200	36 - 2	11.0	0	0	0	0	3-3	1.0
	737-300	39 - 10	12.1	0	0	0	0	3-3	1.0
	737-400	45 - 10	14.0	0	0	0	0	3-3	1.0
	737-500	36 - 2	11.0	0	0	0	0	3-3	1.0
ELECTRICAL ONE CONNECTION - 60 KVA, 200/115 V AC 400 HZ, 3- PHASE EACH	737-100 THRU 737-500	8 - 6	2.6	-	-	2 - 11	0.9	5 - 4	1.6
FUEL ONE UNDERWING- PRESSURE CONNECTOR ON RIGHT WING (SEE SEC 2.1 FOR CAPACITY)	737-100	44 - 1	13.4	-	-	23 - 6	7.2	8 - 0	2.4
	737-200	47 - 1	14.4	-	-	23 - 6	7.2	8 - 0	2.4
	737-300	50 - 9	15.5	-	-	23 - 6	7.2	8 - 0	2.4
	737-400	56 - 9	17.3	-	-	23 - 6	7.2	8 - 0	2.4
	737-500	47 - 1	14.4	-	-	23 - 6	7.2	8 - 0	2.4
FUEL TWO OVERWING FUEL PORTS	737-100	52 - 1	15.8	34 - 3	10.4	34 - 3	10.4	9 - 4	2.8
	737-200	55 - 1	16.8	34 - 3	10.4	34 - 3	10.4	9 - 4	2.8
	737-300	58 - 9	17.9	34 - 3	10.4	34 - 3	10.4	9 - 4	2.8
	737-400	64 - 9	19.7	34 - 3	10.4	34 - 3	10.4	9 - 4	2.8
	737-500	55 - 1	16.8	34 - 3	10.4	34 - 3	10.4	9 - 4	2.8
LAVATORY ONE PRESSURE CONNECTION FOR DRAINING, FLUSHING, AND CHEMICAL FILLING - 17 GAL (64.3 L) CAPACITY 10-GPM (37.9 LPM) 20-PSIG (1.4 KG/SQ CM) SERVICE REQUIRED	737-100	11 - 8	3.6	-	-	3 - 10	1.2	5 - 10	1.8
		72 - 2	22.0	-	-	0 - 10	0.3	7 - 10	2.4
	737-200	11 - 8	3.6	-	-	3 - 10	1.2	5 - 10	1.8
		78 - 6	23.9	-	-	0 - 10	0.3	7 - 10	2.4
	737-300	11 - 8	3.6	-	-	3 - 10	1.2	5 - 10	1.8
		88 - 0	26.8	-	-	0 - 10	0.3	7 - 10	2.4
	737-400	11 - 8	3.6	-	-	3 - 10	1.2	5 - 10	1.8
		98 - 0	29.9	-	-	0 - 10	0.3	7 - 10	2.4
	737-500	11 - 8	3.6	-	-	3 - 10	1.2	5 - 10	1.8
	78 - 6	23.9	-	-	0 - 10	0.3	7 - 10	2.4	
OXYGEN ONE SERVICE CONNECTION FOR OXYGEN FILL - 153 CU FT (4.3 CU M) AT 3,000 PSIG (211 KG/SQ CM) OR 190 CU FT (5.4 CU M) WITH SECOND OBSERVER SEAT.	737-100	21 - 8	6.6	-	-	5 - 0	1.5	6 - 3	1.9
	737-200	21 - 8	6.6	-	-	5 - 0	1.5	6 - 3	1.9
OXYGEN INDIVIDUAL CANISTERS IN EACH PASSENGER SERVICE UNIT	737-300 THRU 737-500	21 - 8	6.6	-	-	3 - 0	0.91	6 - 5	1.96

D6-58325-6

SYSTEM	MODEL	DISTANCE AFT OF NOSE		DISTANCE FROM AIRPLANE CENTERLINE				MAX HEIGHT ABOVE GROUND	
		FT-IN	M	LH SIDE		RH SIDE		FT-IN	M
				FT-IN	M	FT-IN	M		
PNEUMATIC ONE 3-IN (7.6-CM) PORT FOR ENGINE START AND AIRCONDITIONING PACKS	737-100	34 - 2	10.4	-	-	3 - 0	0.9	3 - 8	1.2
	737-200	37 - 3	11.3	-	-	3 - 0	0.9	3 - 8	1.2
	737-300	40 - 10	12.5	-	-	3 - 0	0.9	3 - 8	1.2
	737-400	46 - 10	14.3	-	-	3 - 0	0.9	3 - 8	1.2
	737-500	37 - 2	11.3	-	-	3 - 0	0.9	3 - 8	1.2
POTABLE WATER TWO SERVICE CONNECTIONS 0.75-IN (1.9 CM) AFT LOCATION OPTIONAL	737-100	68 - 11	21.0	1 - 0	0.3	-	-	6 - 4	1.9
		72 - 1	22.0	-	-	4 - 8	1.4	10 - 4	3.2
	737-200	75 - 3	22.9	1 - 0	0.3	-	-	6 - 4	1.9
		78 - 6	23.9	-	-	4 - 8	1.4	10 - 4	3.2
POTABLE WATER ONE SERVICE CONNECTION 0.75-IN (1.9 CM)	737-300	84 - 9	25.8	1 - 0	0.3	4 - 8	1.4	10 - 4	3.2
	737-400	94 - 9	28.9	1 - 0	0.3	4 - 8	1.4	10 - 4	3.2
	737-500	75 - 3	22.9	1 - 0	0.3	4 - 8	1.4	10 - 6	3.2

NOTES:

- DISTANCES ROUNDED TO THE NEAREST INCH AND 0.1 METER.
- AIRPLANE MODEL DESIGNATIONS ALSO INCLUDE ALL DERIVATIVES.

5.5 ENGINE STARTING PNEUMATIC REQUIREMENTS

5.5.1 Engine Start Pneumatic Requirements - Sea Level: Model 737-100, -200

NOTES:

- * JT8D ENGINES
- * MINIMUM STARTING REQUIREMENTS
- * SEA LEVEL
- * COORDINATE WITH USING AIRLINE FOR SPECIFIC PLANNED OPERATING PROCEDURES

EXAMPLE:

AMBIENT TEMPERATURE = 59°F (15°C)
 GROUND CONNECTION TEMPERATURE = 250°F (121°C)
 REQUIRED PRESSURE AT GROUND CONNECTION = 47 PSIA (3.30 KG/SQ CM ABS)
 REQUIRED AIRFLOW AT GROUND CONNECTION = 77 LB/MIN (34.9 KGM/MIN)

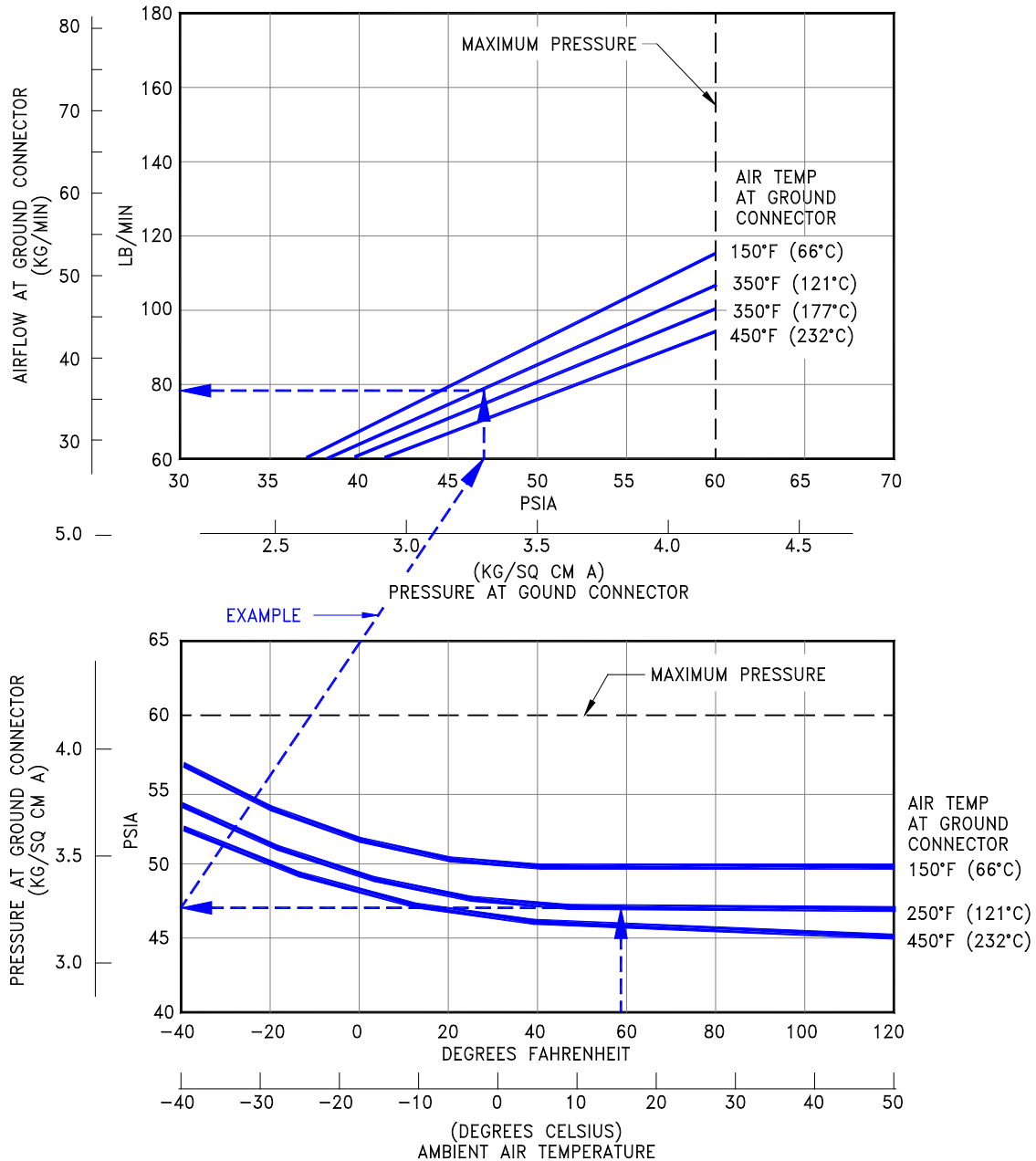

D6-58325-6

5.5.2 Engine Start Pneumatic Requirements - Sea Level: Model 737-300, -400, -500

NOTES:

- * CFM56-3 ENGINES
- * MINIMUM STARTING REQUIREMENTS
- * SEA LEVEL
- * COORDINATE WITH USING AIRLINE FOR SPECIFIC PLANNED OPERATING PROCEDURES

EXAMPLE:

AMBIENT TEMPERATURE = 59°F (15°C)
 GROUND CONNECTION TEMPERATURE = 200°F (93°C)
 REQUIRED PRESSURE AT GROUND CONNECTION = 52.5 PSIA (3.69 KG/SQ CM ABS)
 REQUIRED AIRFLOW AT GROUND CONNECTION = 120 LB/MIN 54.4 KGM/MIN)

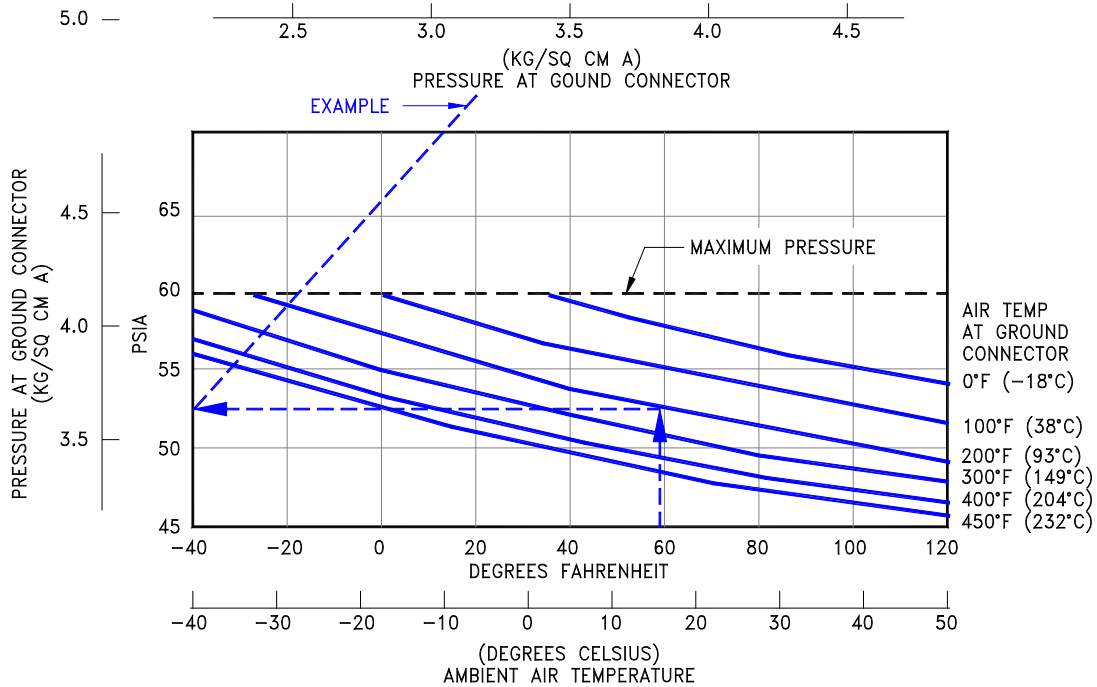
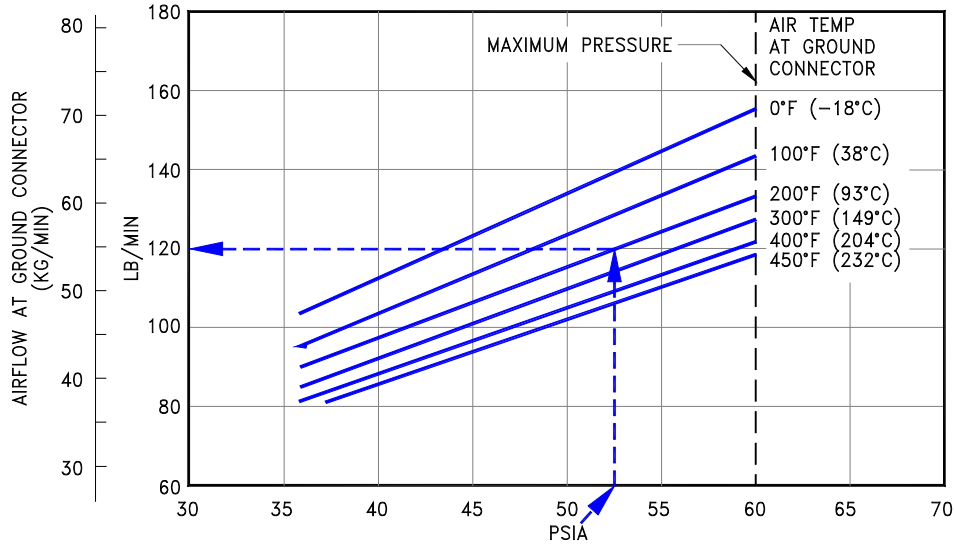

5.6 GROUND PNEUMATIC POWER REQUIREMENTS

5.6.1 Ground Pneumatic Power Requirements - Heating/Cooling: Model 737-100, -200

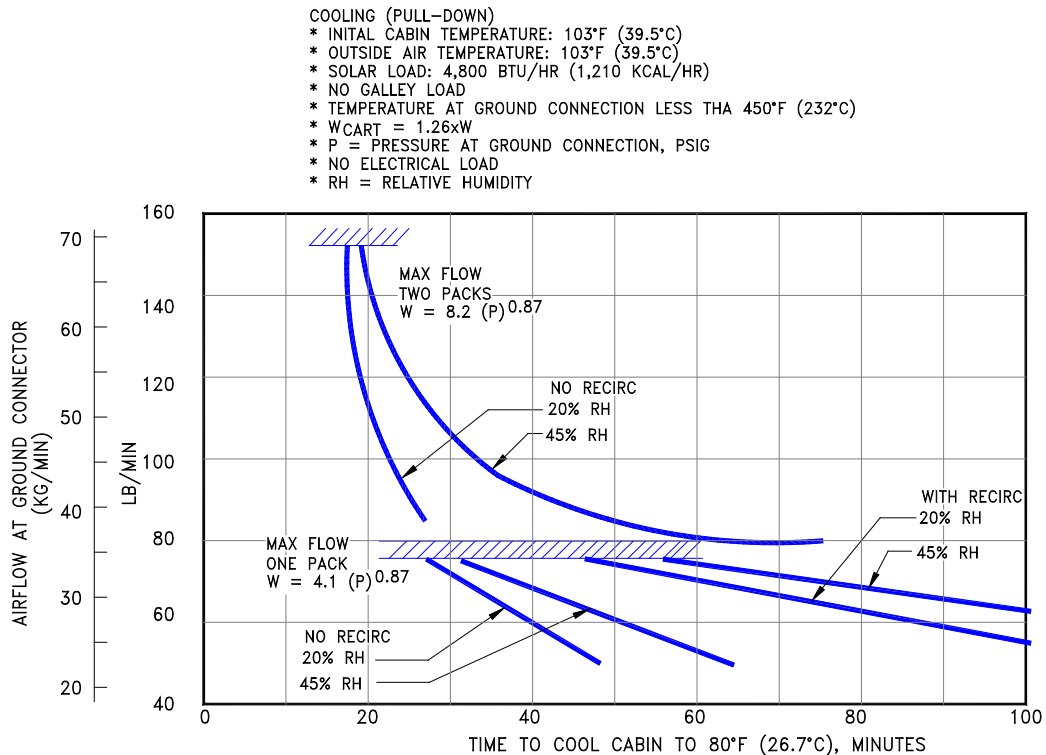
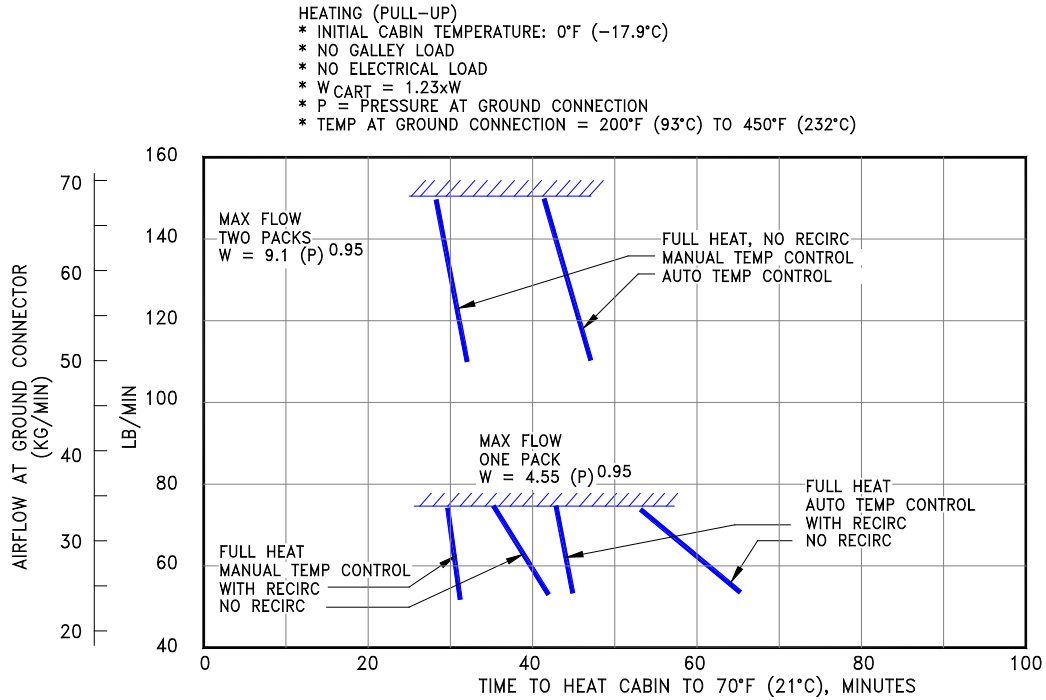

D6-58325-6

5.6.2 Ground Pneumatic Power Requirements - Heating/Cooling: Model 737-300, -500

HEATING (PULL-UP)

- INITIAL CABIN TEMPERATURE - 0°F (-18°C)
- NO GALLEY LOAD
- NO ELECTRICAL LOAD
- $W_{CART} = 1.23 \times W$
- P = PRESSURE AT GROUND CONNECTION
- TEMP AT GROUND CONNECTION 200°F (66°C) TO 450°F (323°C)

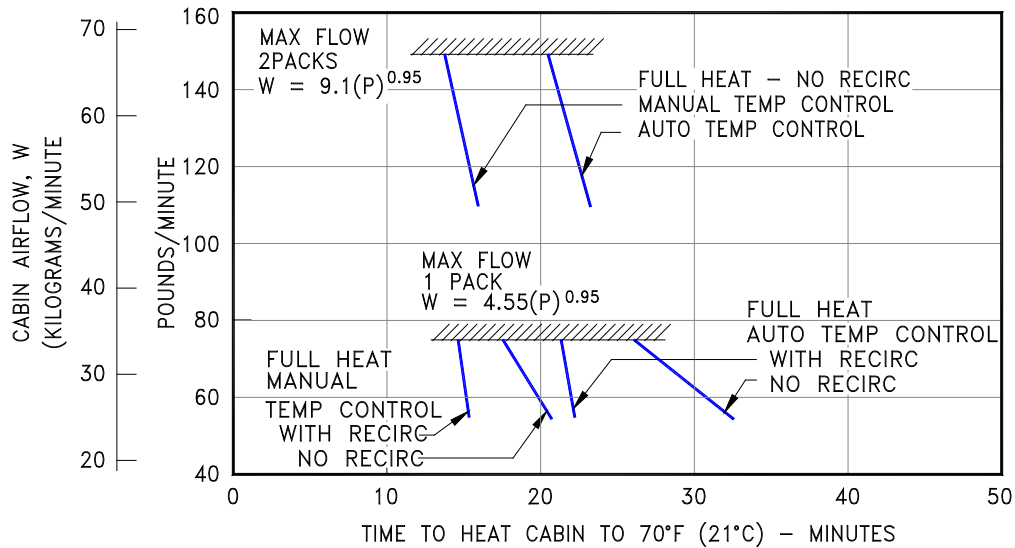

COOLING (PULLDOWN)

- INITIAL CABIN TEMPERATURE - 103°F (39°C)
- OUTSIDE AIR TEMPERATURE - 103°F (39°C)
- SOLAR LOAD - 4,800 BTU/HR (1,210 KCAL/HR)
- NO GALLEY LOAD
- TEMP AT GROUND CONNECTION - LESS THAN 450°F (232°C)
- $W_{CART} = 1.26 \times W$
- P = PRESSURE AT GROUND CONNECTION, PSIG
- NO ELECTRICAL LOAD
- RH = RELATIVE HUMIDITY

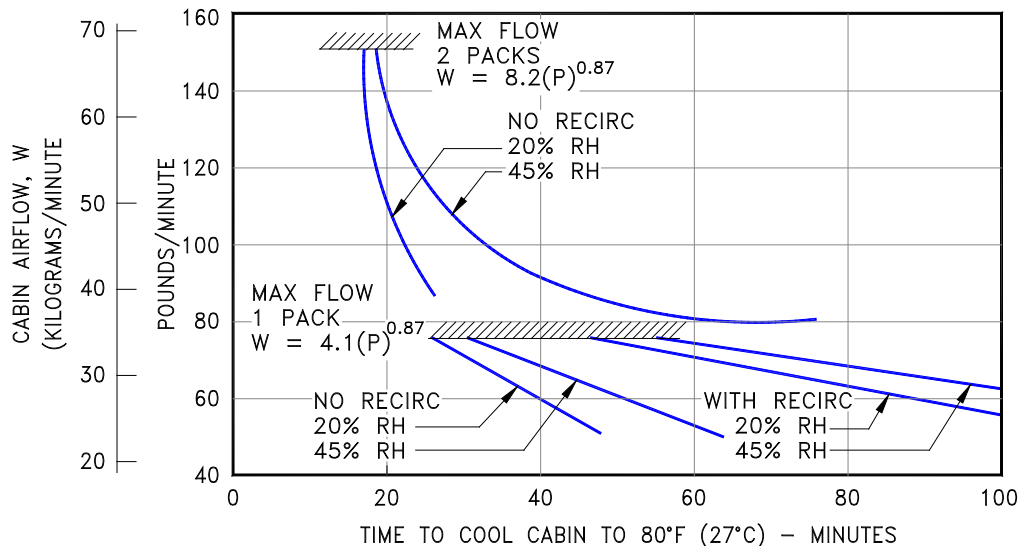

D6-58325-6

5.6.3 Ground Pneumatic Power Requirements - Heating/Cooling: Model 737-400

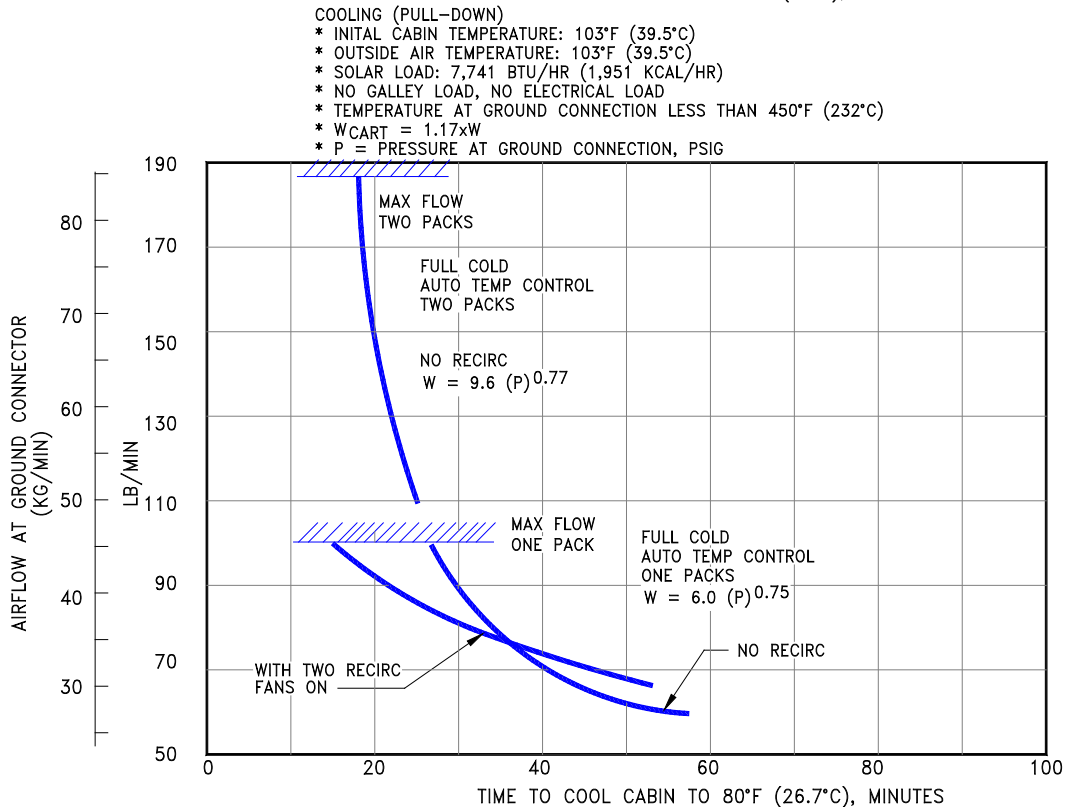
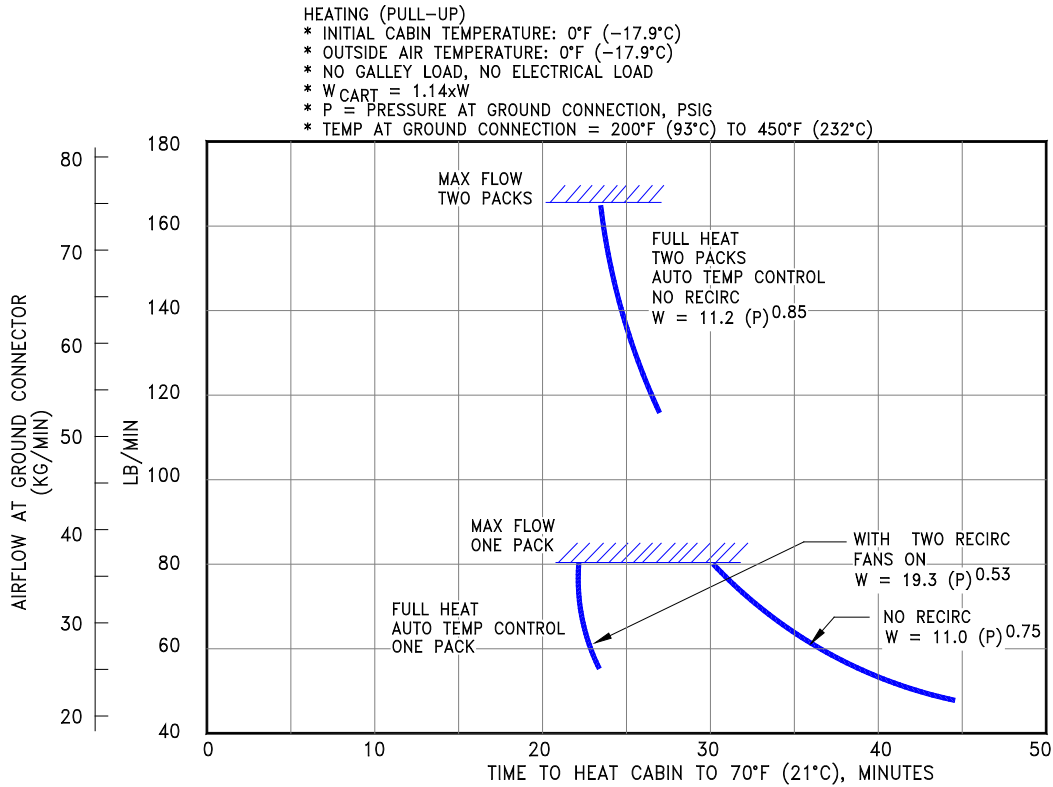

D6-58325-6

5.7 CONDITIONED AIR REQUIREMENTS

5.7.1 Conditioned Air Flow Requirements: Model 737-100, -200

COOLING:

- ① CABIN AT 75° F (24° C); 90 PASSENGERS AND CREW; NO GALLEY LOAD; SOLAR LOAD 5,570 BTU/HR; ELECTRICAL LOAD 6,340 BTU/HR.
- ② CABIN AT 80° F (27° C); OTHERWISE SAME AS IN ①.
- ③ CABIN AT 70° F (21° C); 3 CREW MEMBERS; GALLEY LOAD 8,200 BTU/HR; SOLAR LOAD 5,570 BTU/HR; ELECTRICAL LOAD 6,340 BTU/HR.
- ④ CABIN AT 80° F (27° C); 65 PASSENGERS AND CREW; NO GALLEY LOAD; SOLAR LOAD 5,570 BTU/HR; ELECTRICAL LOAD 6,340 BTU/HR. PRECONDITIONED AIRPLANE.

HEATING:

- ⑤ CABIN AT 75° F (24° C); NO CREW OR PASSENGERS; NO OTHER HEAT LOADS.
- ⑥ CABIN AT 75° F (24° C); NO CREW OR PASSENGERS; NO OTHER HEAT LOADS.
- ⑦ CABIN AT 75° F (24° C); NO CREW OR PASSENGERS; NO OTHER HEAT LOADS.
- ⑧ CABIN AT 75° F (24° C); 65 PASSENGERS AND CREW; NO GALLEY LOAD; NO SOLAR LOAD; ELECTRICAL LOAD 6,430 BTU/HR; PRECONDITIONED AIRPLANE.

ΔP_S = GAGE STATIC PRESSURE IN INCHES OF WATER AT GROUND CONNECTION.

1 BTU/HR = 0.252 KG-CAL/HR

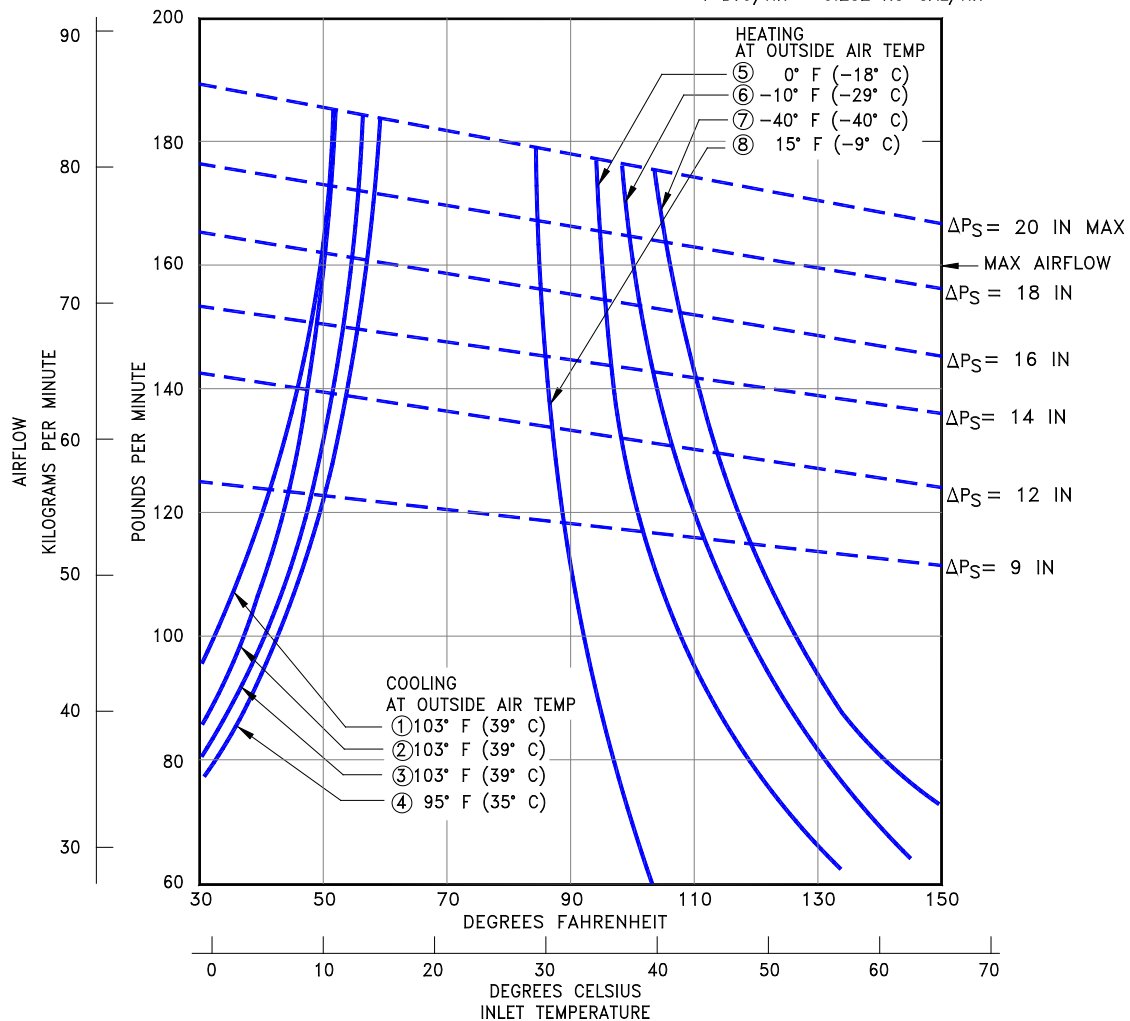

NOTES:

- * AIRFLOW REQUIREMENTS ARE SHOWN FOR THE 737-200 AIRPLANE AND ARE APPROXIMATELY 5 TO 10 LB/MIN GREATER THAN FOR THE 737-100, DEPENDING ON CONDITIONS AND LOADING
- * MAXIMUM RECOMMENDED AIRFLOW = 160 LB/MIN (72 KG/MIN TO AVOID OPENING OF THE DISTRIBUTION RELIEF VALVE)

D6-58325-6

REV D

March 2023

5-24

5.7.2 Conditioned Air Flow Requirements: Model 737-300, -500

COOLING:

- ① CABIN AT 75° F (24° C); 138 PASSENGERS AND CREW; NO GALLEY LOAD; SOLAR LOAD 4,800 BTU/HR; ELECTRICAL LOAD 6,984 BTU/HR.
- ② CABIN AT 80° F (27° C); OTHERWISE SAME AS IN ①.
- ③ CABIN AT 70° F (21° C); 2 CREW MEMBERS; GALLEY LOAD 8,200 BTU/HR; SOLAR LOAD 4,800 BTU/HR; ELECTRICAL LOAD 6,984 BTU/HR.
- ④ CABIN AT 80° F (27° C); 98 PASSENGERS AND CREW; NO GALLEY LOAD; SOLAR LOAD 4,800 BTU/HR; ELECTRICAL LOAD 6,984 BTU/HR. PRECONDITIONED AIRPLANE.

HEATING:

- ⑤ CABIN AT 75° F (24° C); NO CREW OR PASSENGERS; NO OTHER HEAT LOADS.
- ⑥ CABIN AT 75° F (24° C); NO CREW OR PASSENGERS; NO OTHER HEAT LOADS.
- ⑦ CABIN AT 75° F (24° C); NO CREW OR PASSENGERS; NO OTHER HEAT LOADS.
- ⑧ CABIN AT 75° F (24° C); 98 PASSENGERS AND CREW; NO GALLEY LOAD; NO SOLAR LOAD; ELECTRICAL LOAD 6,984 BTU/HR; PRECONDITIONED AIRPLANE.

ΔP_S = GAGE STATIC PRESSURE IN INCHES OF WATER AT GROUND CONNECTION.

1 BTU/HR = 0.252 KG-CAL/HR

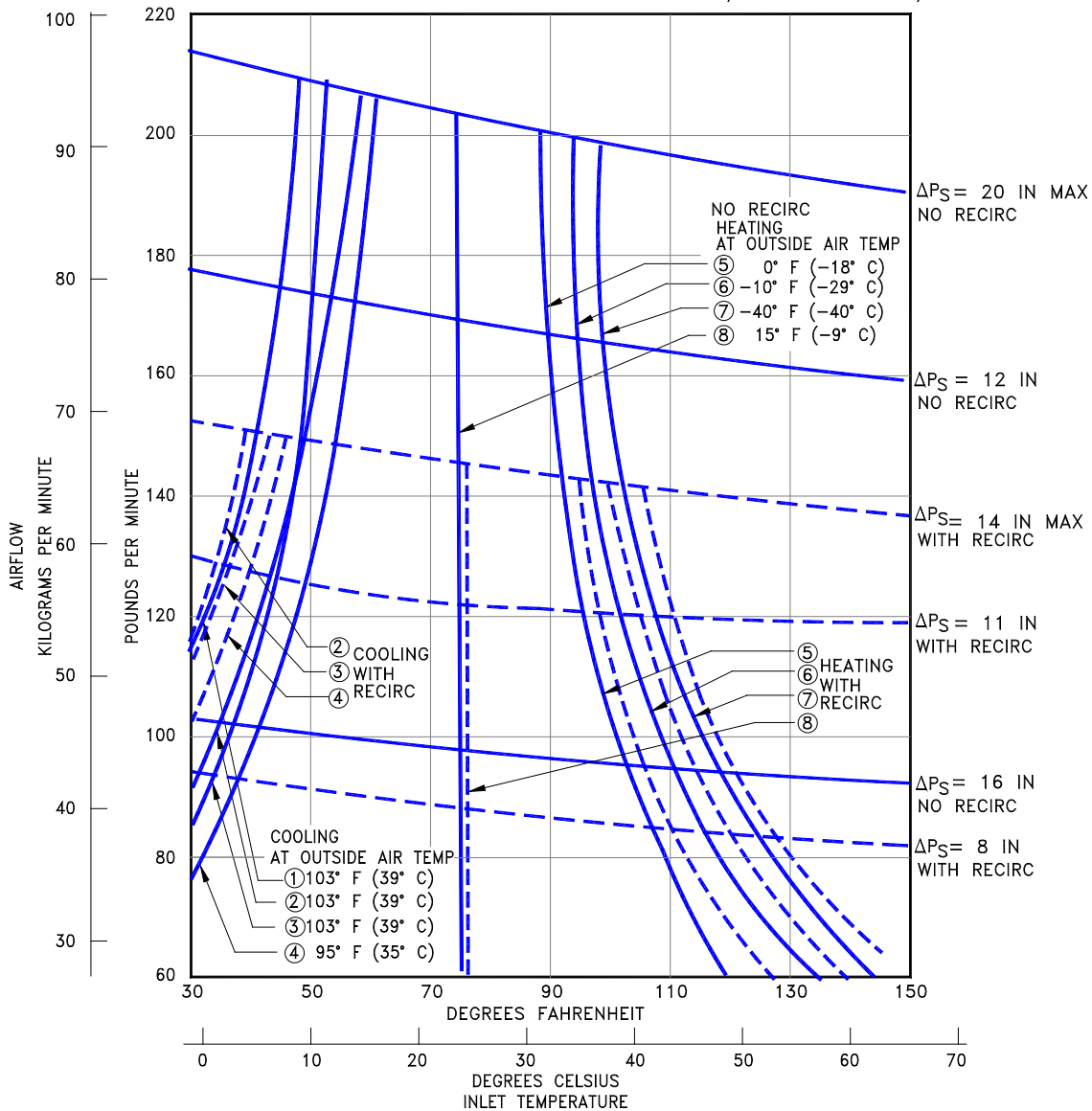

D6-58325-6

REV D

March 2023

5-25

5.7.3 Conditioned Air Flow Requirements: Model 737-400

COOLING:

- ① CABIN AT 75° F (24° C); 165 PASSENGERS AND CREW; NO GALLEY LOAD; SOLAR LOAD 7,741 BTU/HR; ELECTRICAL LOAD 10,955 BTU/HR.
- ② CABIN AT 80° F (27° C); OTHERWISE SAME AS IN ①.
- ③ CABIN AT 70° F (21° C); 2 CREW MEMBERS; GALLEY LOAD 8,200 BTU/HR; SOLAR LOAD 7,741 BTU/HR; ELECTRICAL LOAD 10,955 BTU/HR.
- ④ CABIN AT 80° F (27° C); 117 PASSENGERS AND CREW; NO GALLEY LOAD; SOLAR LOAD 7,741 BTU/HR; ELECTRICAL LOAD 10,955 BTU/HR. PRECONDITIONED AIRPLANE.

HEATING:

- ⑤ CABIN AT 75° F (24° C); NO CREW OR PASSENGERS; NO OTHER HEAT LOADS.
- ⑥ CABIN AT 75° F (24° C); NO CREW OR PASSENGERS; NO OTHER HEAT LOADS.
- ⑦ CABIN AT 75° F (24° C); NO CREW OR PASSENGERS; NO OTHER HEAT LOADS.
- ⑧ CABIN AT 75° F (24° C); 117 PASSENGERS AND CREW; NO GALLEY LOAD; NO SOLAR LOAD; ELECTRICAL LOAD 10,955 BTU/HR; PRECONDITIONED AIRPLANE.

ΔP_S = GAGE STATIC PRESSURE IN INCHES OF WATER AT GROUND CONNECTION.

1 BTU/HR = 0.252 KG-CAL/HR

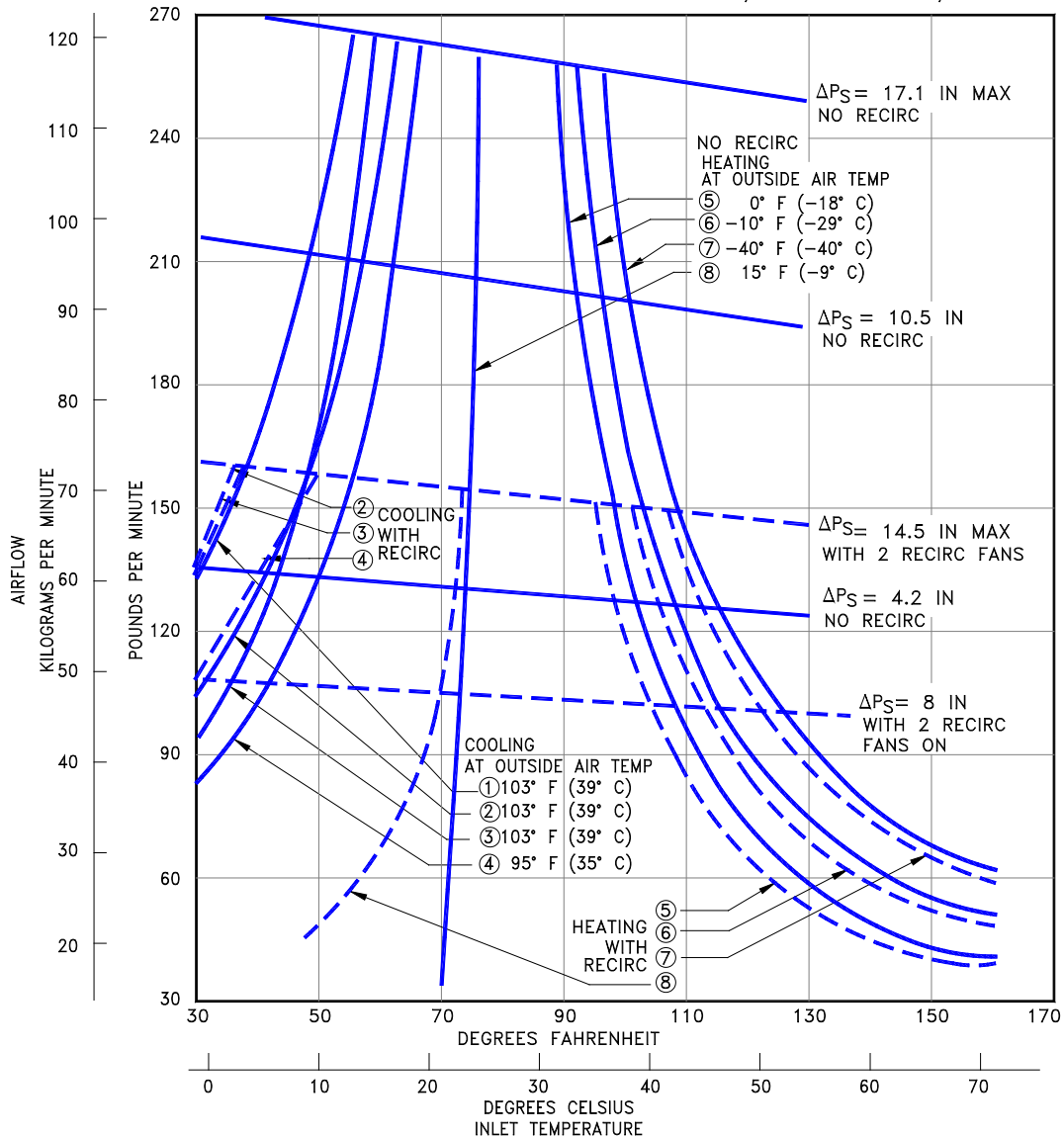

D6-58325-6

5.8 GROUND TOWING REQUIREMENTS

5.8.1 Ground Towing Requirements - English Units: Model 737, All Models

NOTES:

- UNUSUAL BREAKAWAY CONDITIONS NOT REFLECTED
- ESTIMATED FOR RUBBER-TIRED TOW VEHICLES
- COEFFICIENT OF FRICTION (μ) APPROXIMATE

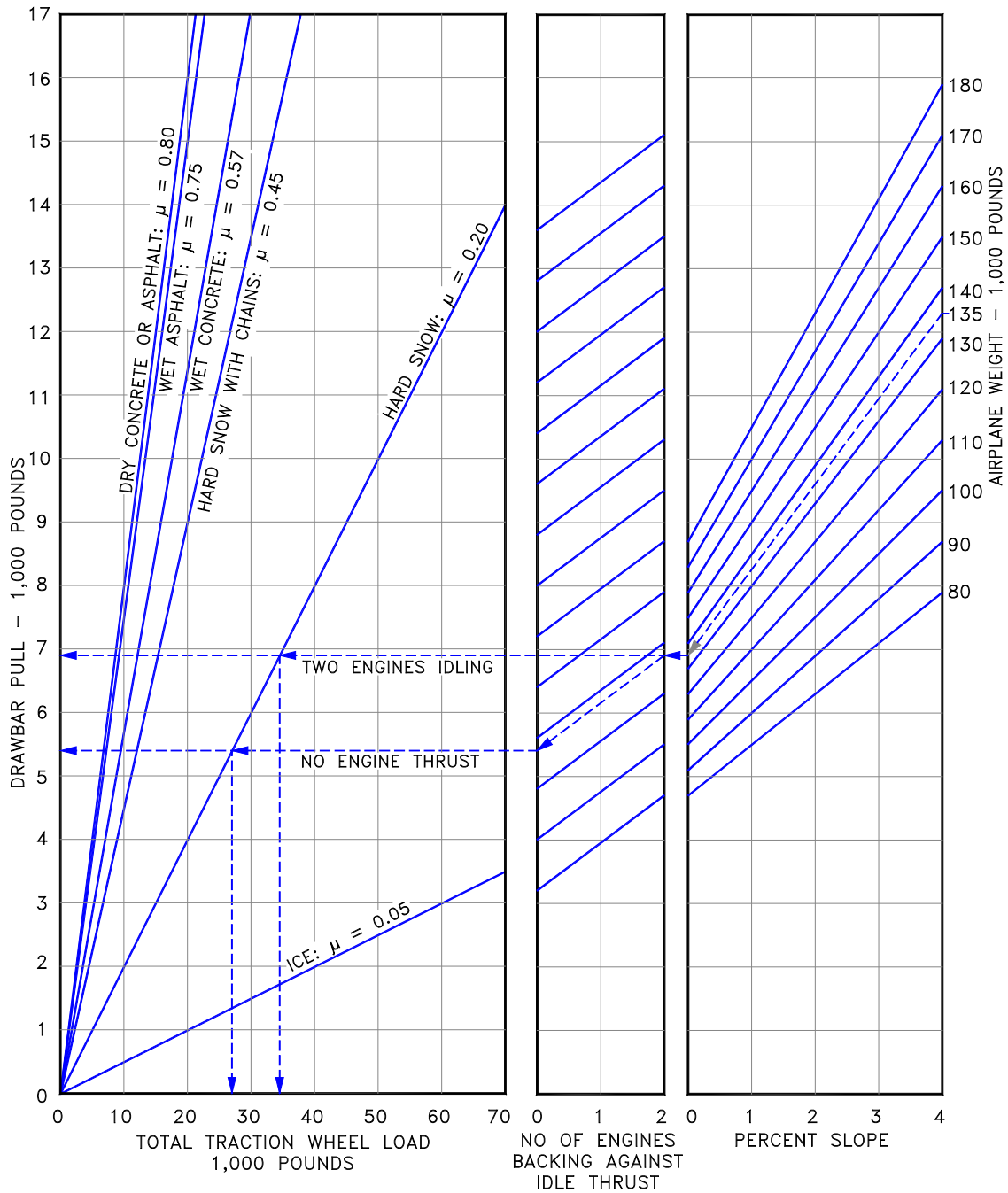

D6-58325-6

5.8.2 Ground Towing Requirements - Metric Units: Model 737, All Models

NOTES:

- UNUSUAL BREAKAWAY CONDITIONS NOT REFLECTED
- ESTIMATED FOR RUBBER-TIRED TOW VEHICLES
- COEFFICIENT OF FRICTION (μ) APPROXIMATE

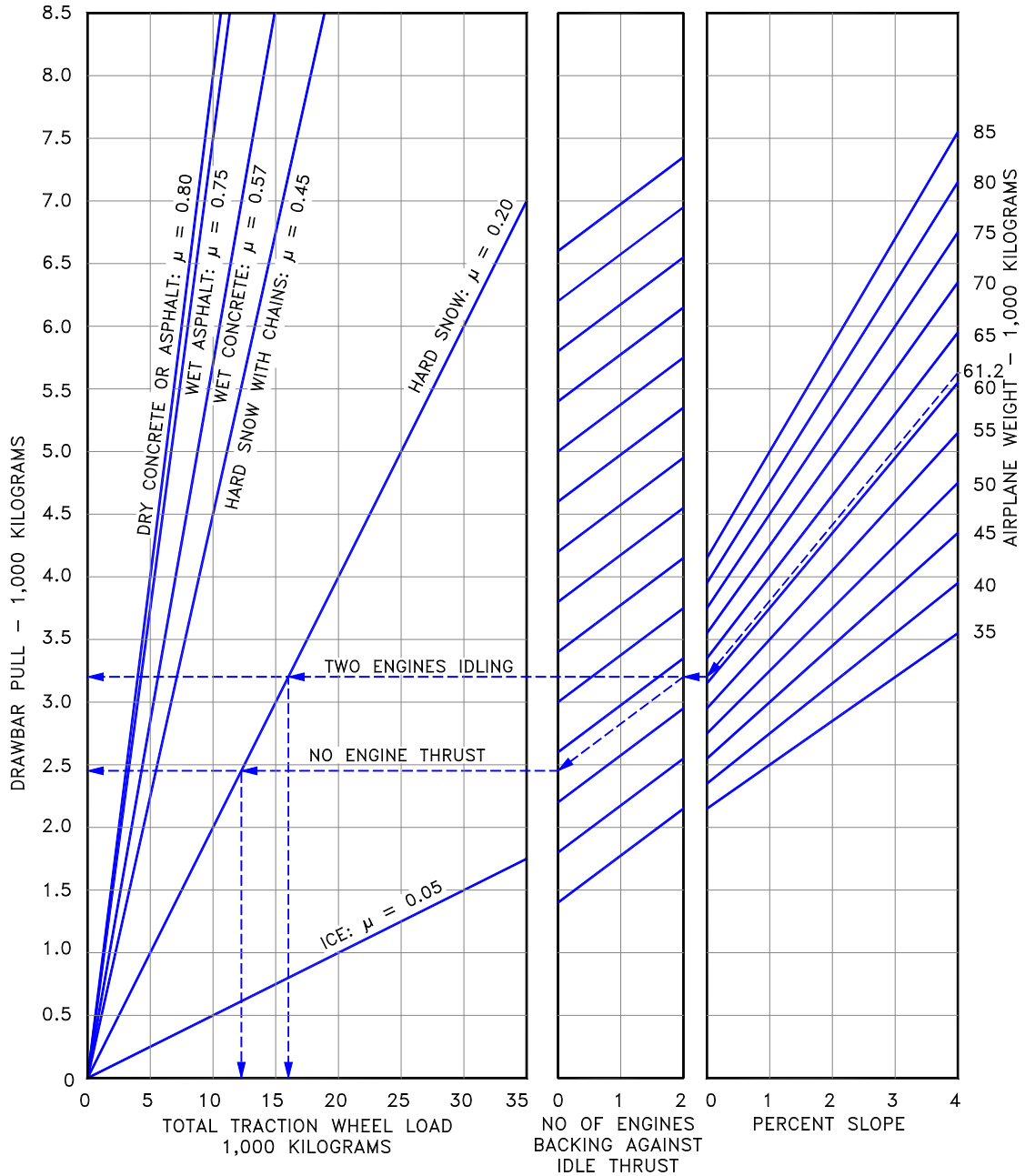

D6-58325-6

6.0 JET ENGINE WAKE AND NOISE DATA

6.1 JET ENGINE EXHAUST VELOCITIES AND TEMPERATURES

This section shows jet engine exhaust velocity and temperature contours aft of the 737 Series of airplanes. The contours were calculated from a standard computer analysis using three-dimensional viscous flow equations with mixing of primary, fan, and free-stream flow. The presence of the ground plane is included in the calculations as well as engine tilt and toe-in. Mixing of flows from the engines is also calculated. The analysis does not include thermal buoyancy effects which tend to elevate the jet wake above the ground plane. The buoyancy effects are considered to be small relative to the exhaust velocity and therefore are not included.

The graphs show jet wake velocity and temperature contours for representative engines. The results are valid for sea level, static, standard day conditions. The effect of wind on jet wakes is not included. There is evidence to show that a downwind or an upwind component does not simply add or subtract from the jet wake velocity, but rather carries the whole envelope in the direction of the wind. Crosswinds may carry the jet wake contour far to the side at large distances behind the airplane.

It should be understood, these exhaust velocity contours reflect steady-state, at maximum taxi weight, and not transient-state exhaust velocities. A steady-state is achieved with the aircraft in a fixed location, engine running at a given thrust level and measured when the contours stop expanding and stabilize in size, which could take several seconds. The steady-state condition, therefore, is conservative. Contours shown also do not account for performance variables such as ambient temperature or field elevation. For the terminal area environment, the transient-state is a more accurate representation of the actual exhaust contours when the aircraft is in motion and encountering static air with forward or turning movement, but it is very difficult to model on a consistent basis due to aircraft weight, weather conditions, the high degree of variability in terminal and apron configurations, and intensive numerical calculations. If the contours presented here are overly restrictive for terminal operations, The Boeing Company recommends conducting an analysis of the actual exhaust contours experienced by the using aircraft at the airport.

6.1.1 Jet Engine Exhaust Velocity Contours – Idle Thrust: Model 737-100, -200

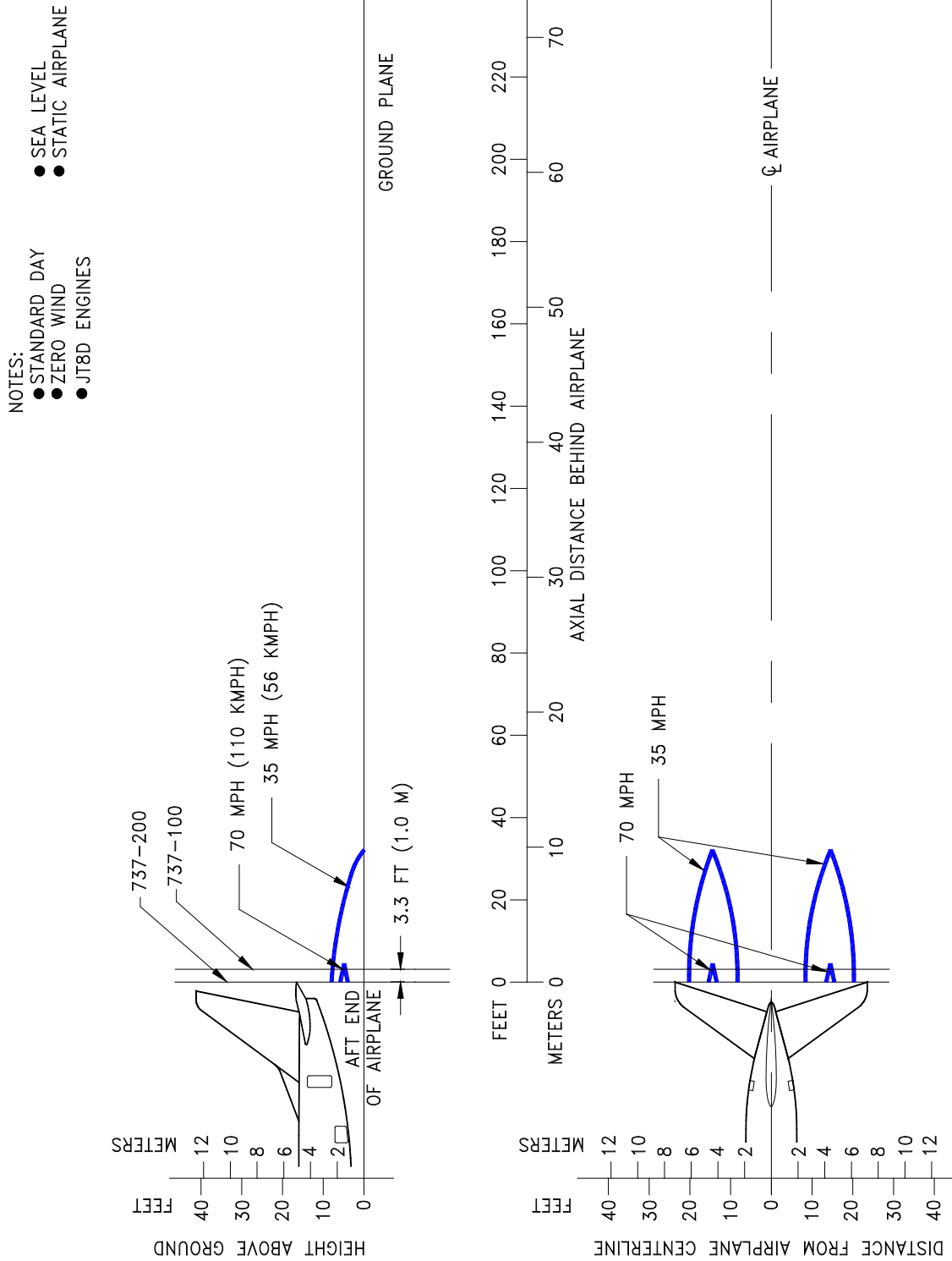

D6-58325-6

REV D

March 2023

6-2

6.1.2 Jet Engine Exhaust Velocity Contours – Idle Thrust: Model 737-300, -400, -500

- NOTES:
- STANDARD DAY
 - ZERO WIND
 - SEA LEVEL
 - STATIC AIRPLANE

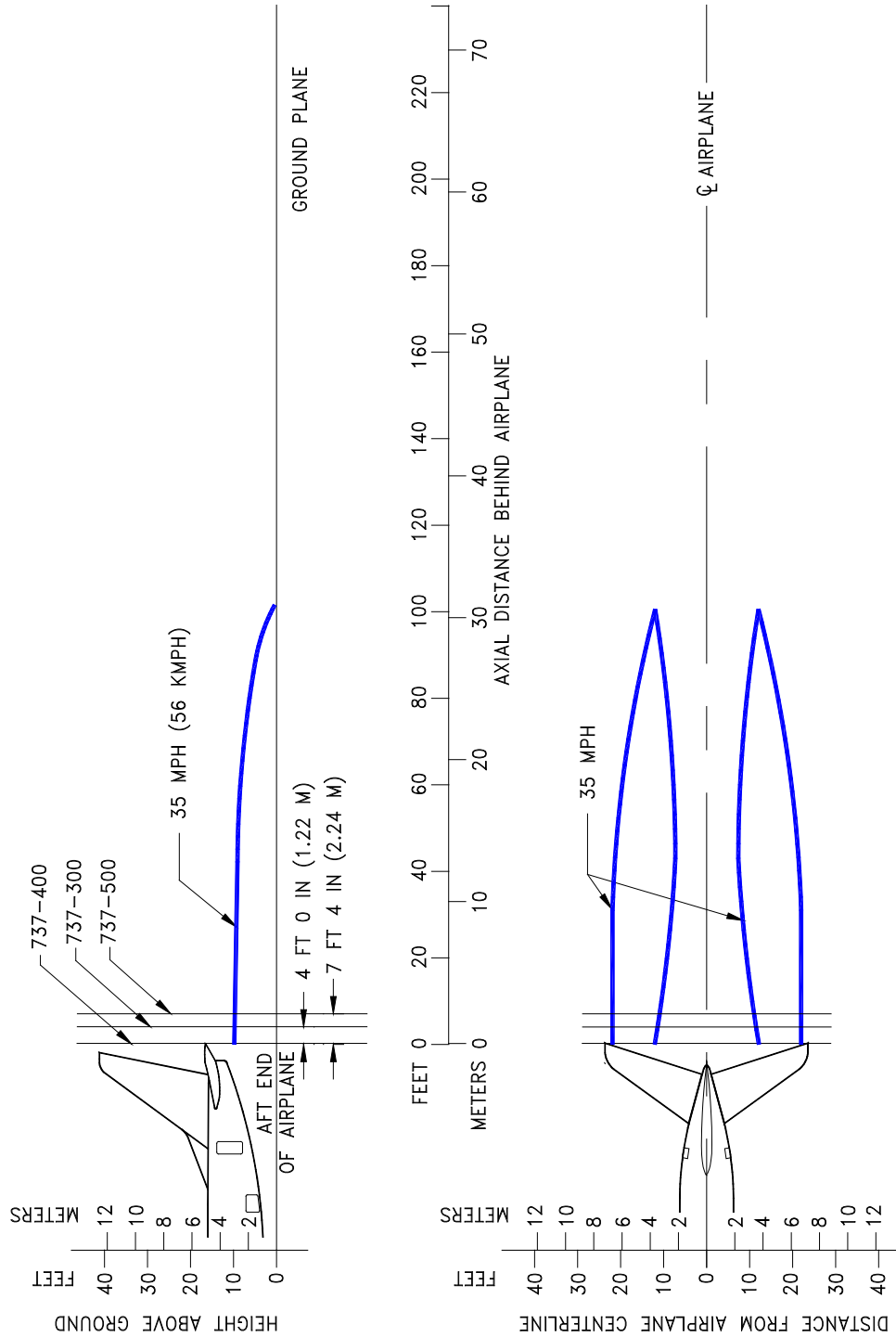

D6-58325-6

REV D

March 2023

6-3

6.1.3 Jet Engine Exhaust Velocity Contours - Breakaway Thrust: Model 737-100, -200

- NOTES:
- STANDARD DAY
 - SEA LEVEL
 - ZERO WIND
 - JT8D ENGINES
 - STATIC AIRPLANE

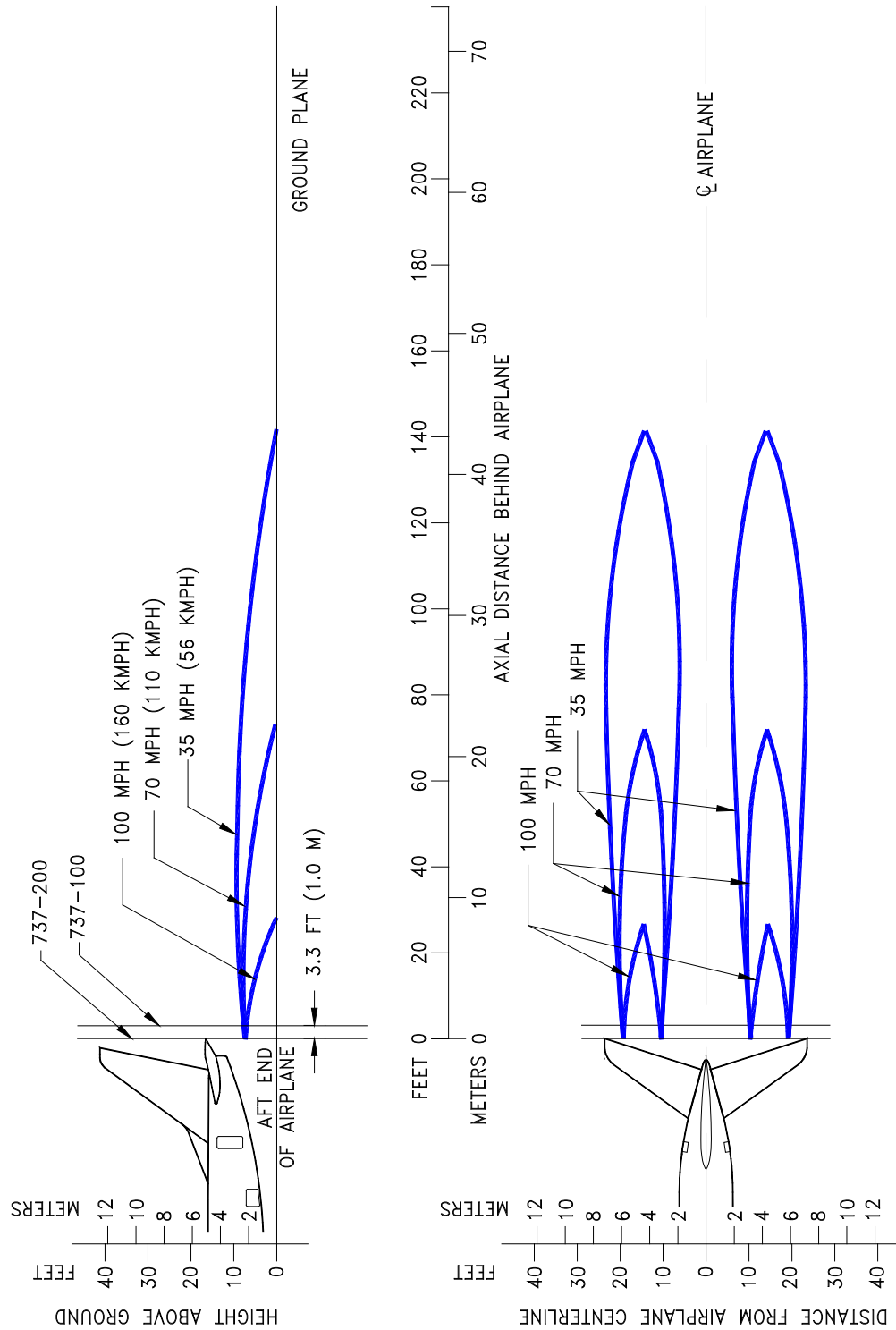

D6-58325-6

6.1.4 Jet Engine Exhaust Velocity Contours - Breakaway Thrust: Model 737-300, -400, -500

- NOTES:
- SEA LEVEL
 - STANDARD DAY
 - ZERO WIND
 - STATIC AIRPLANE

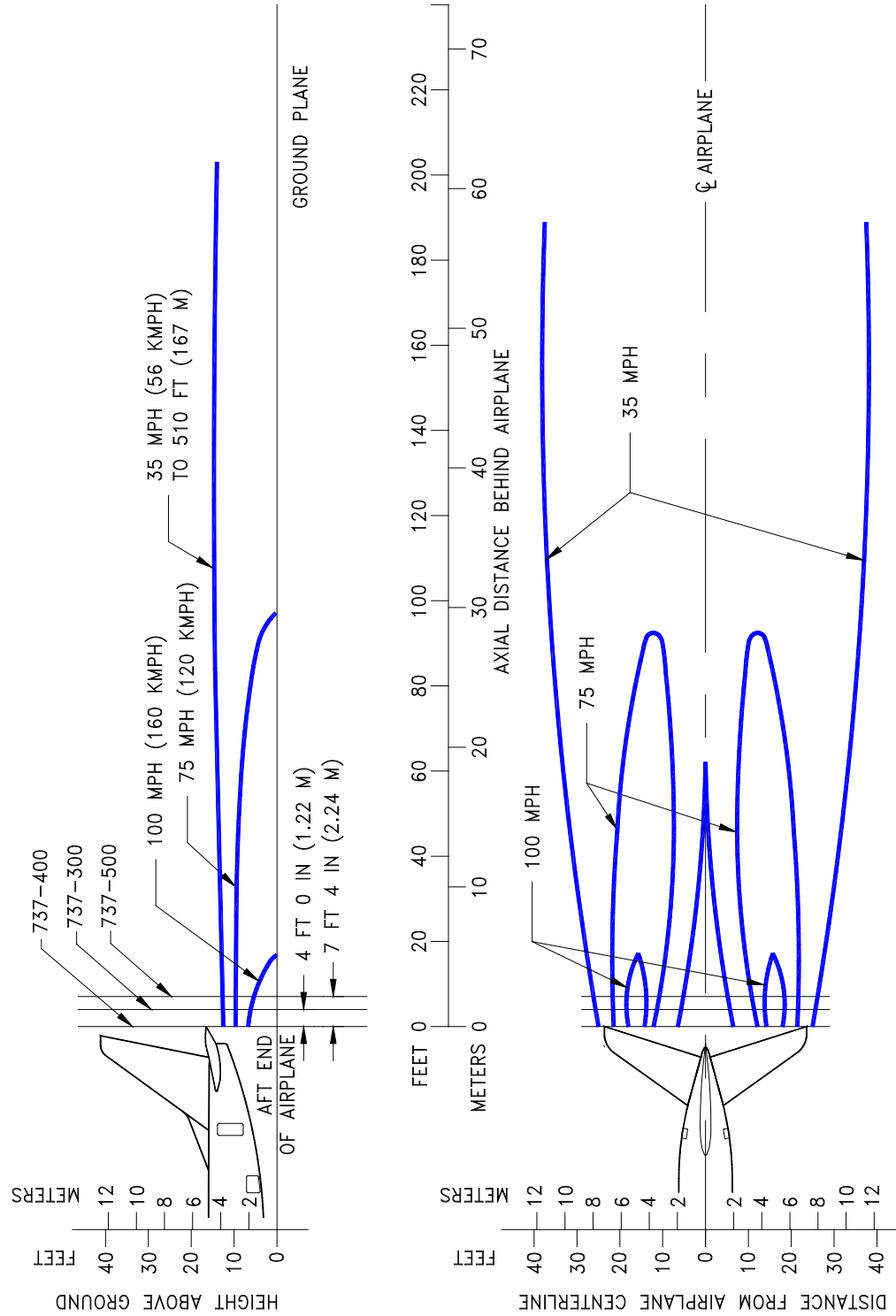

D6-58325-6

6.1.5 Jet Engine Exhaust Velocity Contours - Takeoff Thrust: Model 737-100, -200

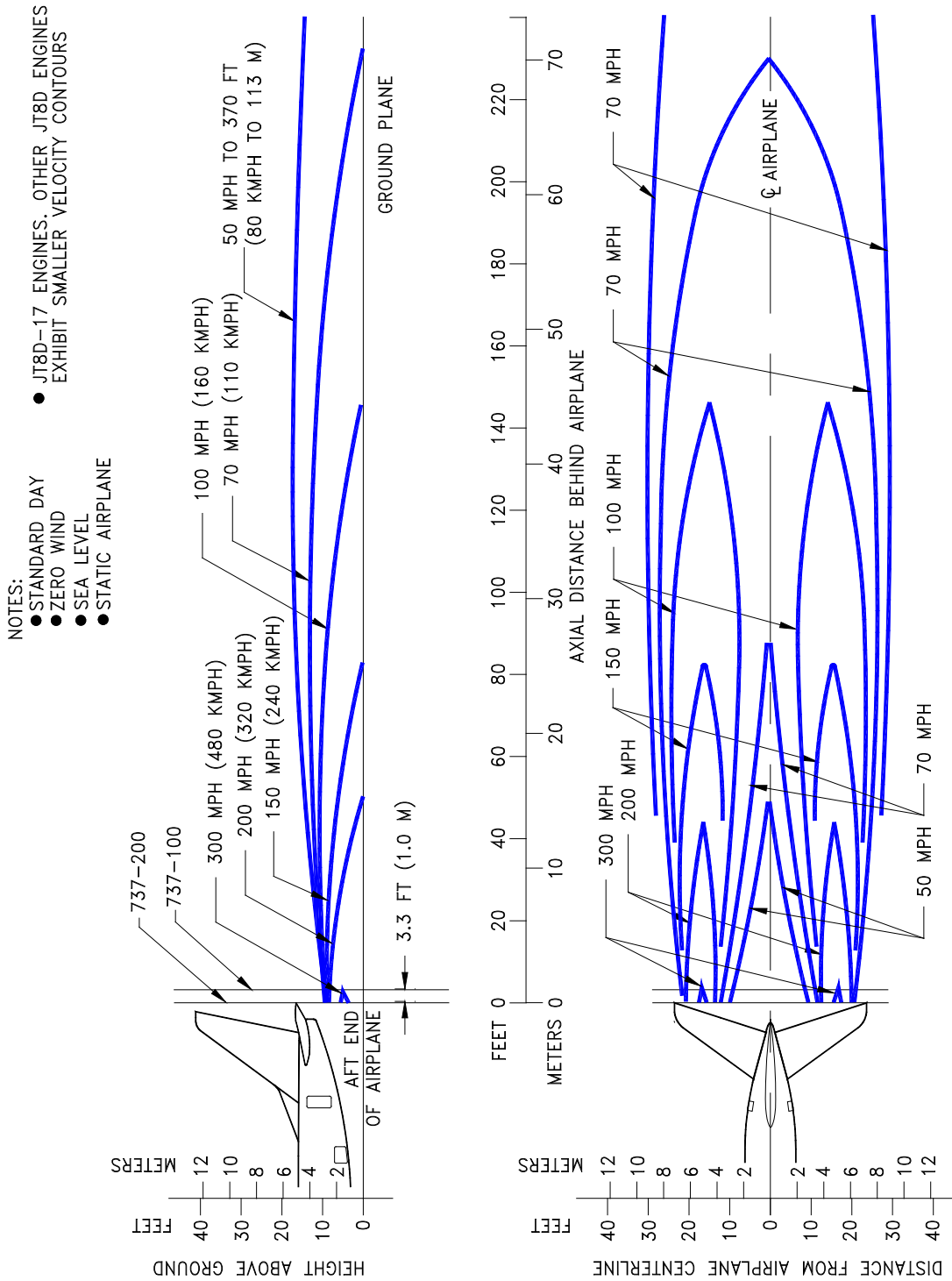

D6-58325-6

REV D

March 2023

6-6

6.1.6 Jet Engine Exhaust Velocity Contours - Takeoff Thrust: Model 737-300, -400, -500

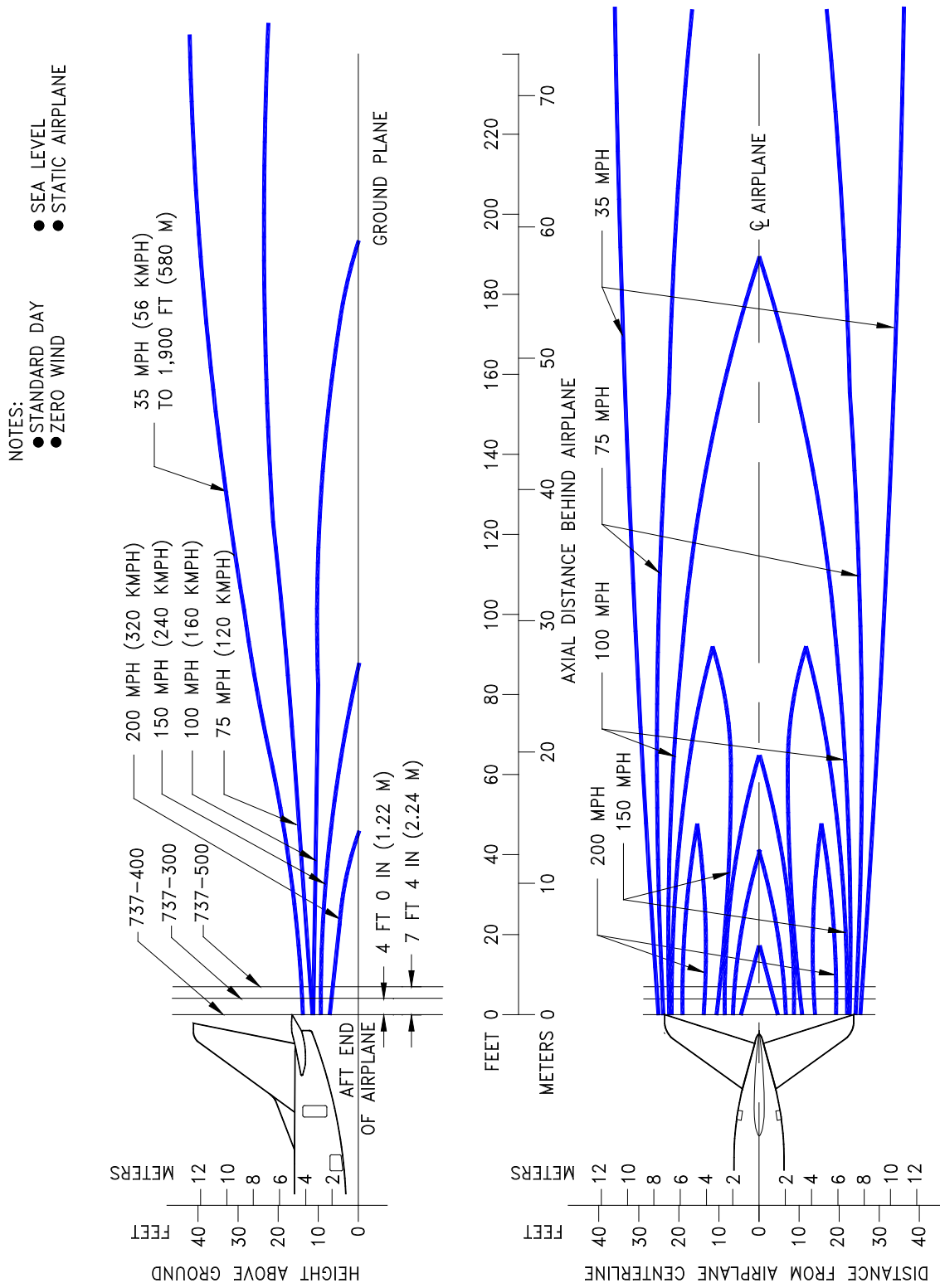

D6-58325-6

6.1.7 Jet Engine Exhaust Temperature Contours - Idle Thrust: Model 737-100, -200

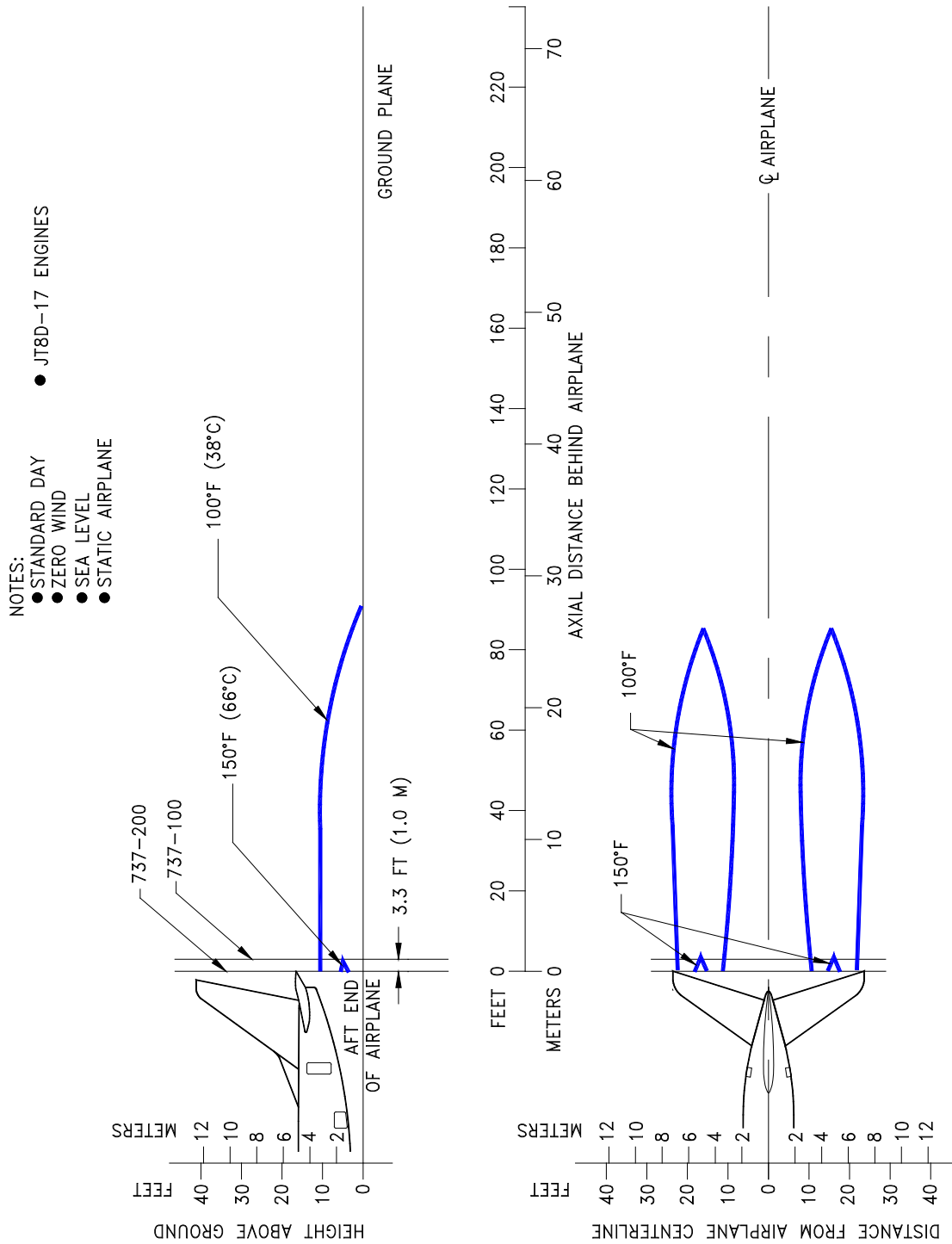

D6-58325-6

REV D

March 2023

6-8

6.1.8 Jet Engine Exhaust Temperature Contours - Idle Thrust: Model 737-300, -400, -500

Temperature contours for idle power conditions are not shown as the maximum temperature aft of the 737-300, -400, -500 is predicated to be less than 100° F (38° C) for standard day conditions of 59° F (15° C).

6.1.9 Jet Engine Exhaust Temperature Contours – Breakaway Thrust: Model 737-100, -200

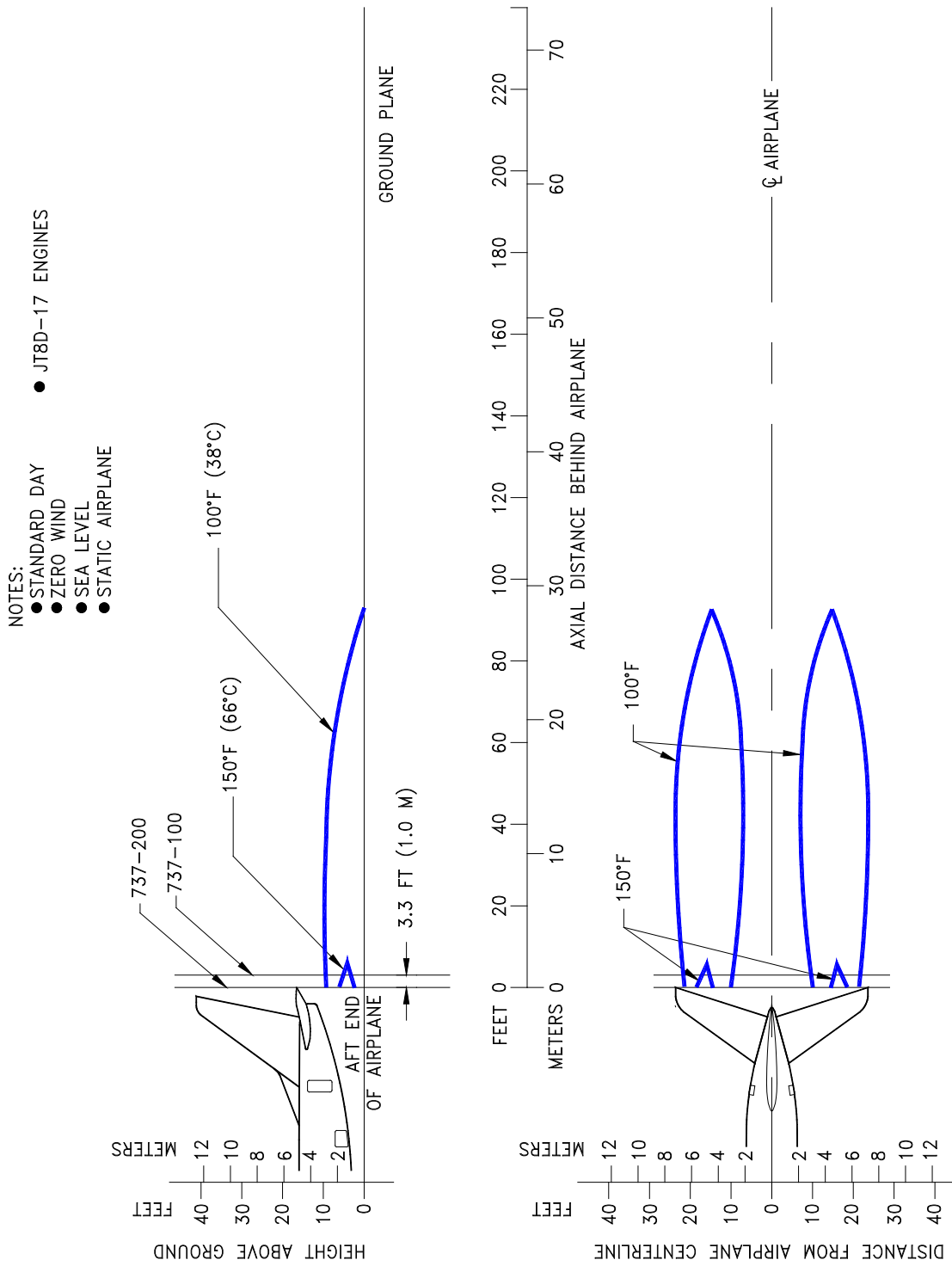

D6-58325-6

6.1.10 Jet Engine Exhaust Temperature Contours – Breakaway Thrust: Model 737-300, -400, -500

Temperature contours for breakaway power conditions are not shown as the maximum temperature aft of the 737-300, -400, -500 is predicated to be less than 100° F (38° C) for standard day conditions of 59° F (15° C).

6.1.11 Jet Engine Exhaust Temperature Contours – Takeoff Thrust: Model 737-100, -200

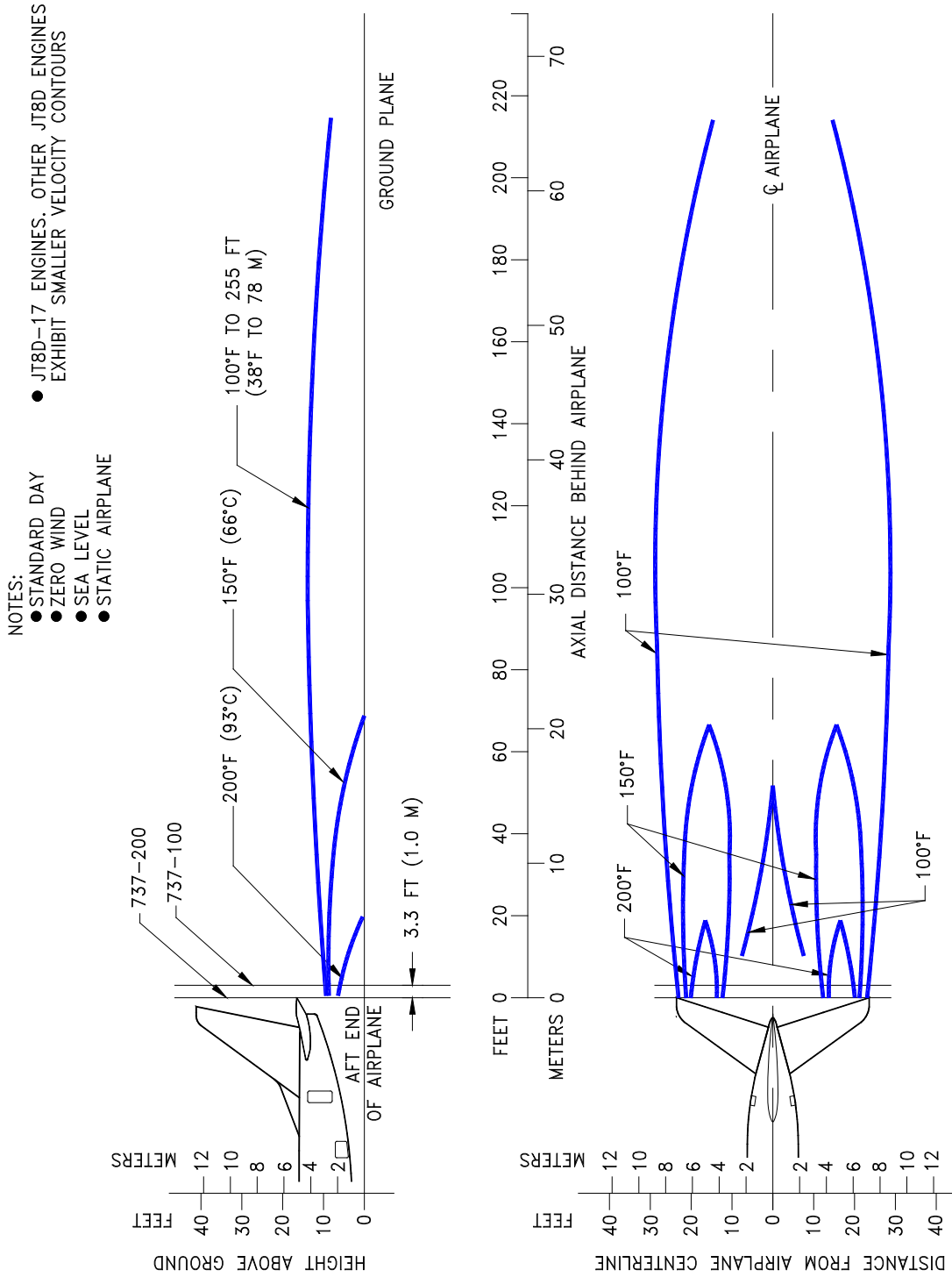

D6-58325-6

REV D

March 2023

6-12

6.1.12 Jet Engine Exhaust Temperature Contours – Takeoff Thrust: Model 737-300, -400, -500

- NOTES:
- STANDARD DAY
 - ZERO WIND
 - SEA LEVEL
 - STATIC AIRPLANE

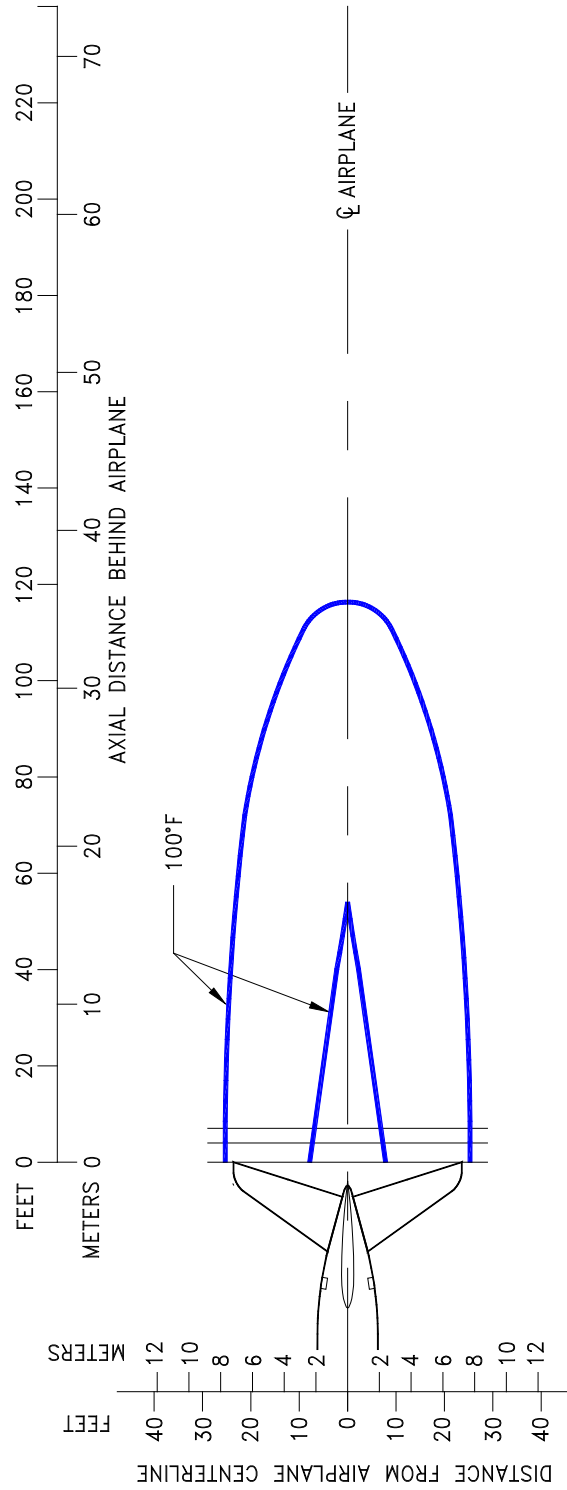
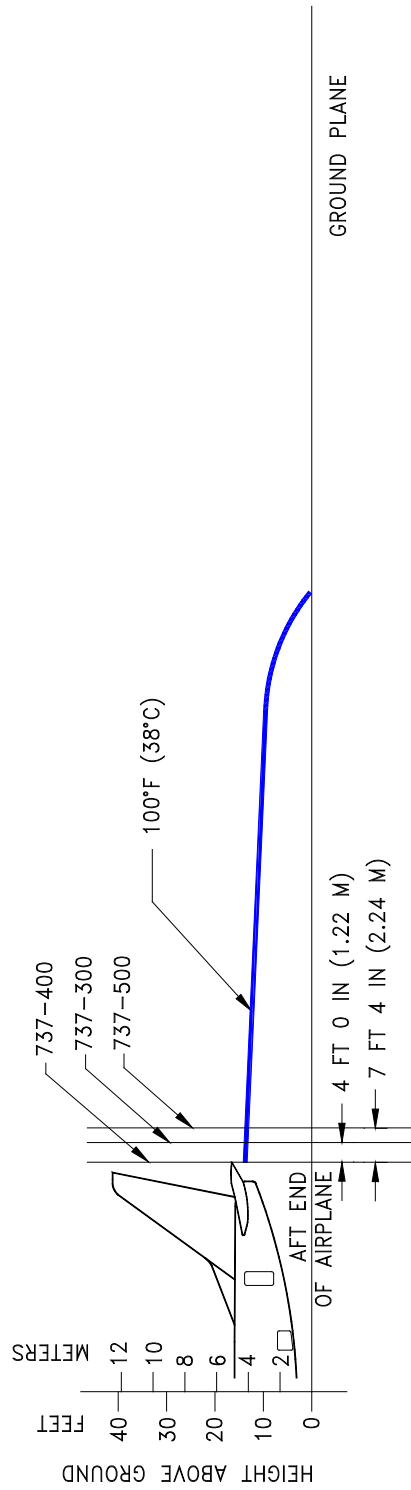

D6-58325-6

6.2 AIRPORT AND COMMUNITY NOISE

Airport noise is of major concern to the airport and community planner. The airport is a major element in the community's transportation system and, as such, is vital to its growth. However, the airport must also be a good neighbor, and this can be accomplished only with proper planning. Since aircraft noise extends beyond the boundaries of the airport, it is vital to consider the impact on surrounding communities. Many means have been devised to provide the planner with a tool to estimate the impact of airport operations. Too often they oversimplify noise to the point where the results become erroneous. Noise is not a simple subject; therefore, there are no simple answers.

The cumulative noise contour is an effective tool. However, care must be exercised to ensure that the contours, used correctly, estimate the noise resulting from aircraft operations conducted at an airport.

The size and shape of the single-event contours, which are inputs into the cumulative noise contours, are dependent upon numerous factors. They include the following:

1. Operational Factors
 - a. Aircraft Weight-Aircraft weight is dependent on distance to be traveled, enroute winds, payload, and anticipated aircraft delay upon reaching the destination.
 - b. Engine Power Settings-The rates of ascent and descent and the noise levels emitted at the source are influenced by the power setting used.
 - c. Airport Altitude-Higher airport altitude will affect engine performance and thus can influence noise.
2. Atmospheric Conditions-Sound Propagation
 - a. Wind-With stronger headwinds, the aircraft can take off and climb more rapidly relative to the ground. Also, winds can influence the distribution of noise in surrounding communities.
 - b. Temperature and Relative Humidity-The absorption of noise in the atmosphere along the transmission path between the aircraft and the ground observer varies with both temperature and relative humidity.
3. Surface Condition-Shielding, Extra Ground Attenuation (EGA)
 - a. Terrain-If the ground slopes down after takeoff or before landing, noise will be reduced since the aircraft will be at a higher altitude above ground. Additionally, hills, shrubs, trees, and large buildings can act as sound buffers.

All these factors can alter the shape and size of the contours appreciably. To demonstrate the effect of some of these factors, estimated noise level contours for two different

operating conditions are shown below. These contours reflect a given noise level upon a ground level plane at runway elevation.

Condition 1

Landing	Takeoff
Maximum Structural Landing Weight	Maximum Gross Takeoff Weight
10-knot Headwind	Zero Wind
3° Approach	84 °F
84 °F	Humidity 15%
Humidity 15%	

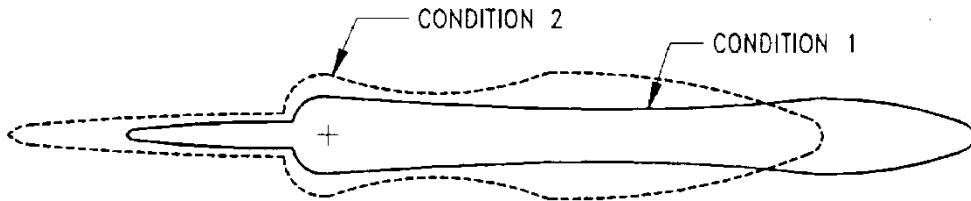

Condition 2

Landing	Takeoff
85% of Maximum Structural Landing Weight	80% of Maximum Gross Takeoff Weight
10-knot Headwind	10-knot Headwind
3° Approach	59 °F (15 °C)
59 °F (15 °C)	Humidity 70%
Humidity 70%	

As indicated from the data, the contour size varies substantially with operating and atmospheric conditions. Most aircraft operations are, of course, conducted at less than maximum gross weights because average flight distances are much shorter than maximum aircraft range capability and average load factors are less than 100%. Therefore, in developing cumulative contours for planning purposes, it is recommended that the airlines serving a particular city be contacted to provide operational information.

In addition, there are no universally accepted methods for developing aircraft noise contours or for relating the acceptability of specific zones to specific land uses. It is

therefore expected that noise contour data for particular aircraft and the impact assessment methodology will be changing. To ensure that the best currently available information of this type is used in any planning study, it is recommended that it be obtained directly from the Office of Environmental Quality in the Federal Aviation Administration in Washington, D.C.

It should be noted that the contours shown herein are only for illustrating the impact of operating and atmospheric conditions and do not represent the single-event contour of the family of aircraft described in this document. It is expected that the cumulative contours will be developed as required by planners using the data and methodology applicable to their specific study.

7.0 PAVEMENT DATA

7.1 GENERAL INFORMATION

A brief description of the pavement charts that follow will help in their use for airport planning. Each airplane configuration is depicted with a minimum range of five loads imposed on the main landing gear to aid in interpolation between the discrete values shown. All curves for any single chart represent data based on rated loads and tire pressures considered normal and acceptable by current aircraft tire manufacturer's standards. Tire pressures, where specifically designated on tables and charts, are at values obtained under loaded conditions as certificated for commercial use.

Section 7.2 presents basic data on the landing gear footprint configuration, maximum design taxi loads, and tire sizes and pressures.

Maximum pavement loads for certain critical conditions at the tire-to-ground interface are shown in Section 7.3, with the tires having equal loads on the struts.

Pavement requirements for commercial airplanes are customarily derived from the static analysis of loads imposed on the main landing gear struts. The charts in Section 7.4 are provided in order to determine these loads throughout the stability limits of the airplane at rest on the pavement. These main landing gear loads are used as the point of entry to the pavement design charts, interpolating load values where necessary.

The flexible pavement design curves based on the US Army Corp of Engineers Method and the rigid pavement curves based on the Portland Cement Association Design Method are no longer provided in Sections 7.5 and 7.7. Refer to the State's design standards for pavement design requirements. For US airports, refer to FAA Advisory Circular (AC) 150/5320-6, "Pavement Design" and pavement design program FAARFIELD for flexible and rigid pavement design requirements.

The Load Classification Number (LCN) curves are no longer provided in section 7.6 and 7.8 since the LCN system for reporting pavement strength is obsolete, being replaced by the ICAO recommended ACN/PCN system in 1983. For questions regarding the LCN system contact Boeing Airport Operations Engineering:

AirportCompatibility@boeing.com

The ACN/PCN system (Section 7.10) as referenced in ICAO Annex 14, "Aerodromes," 8th Edition, July 2018, provides a standardized international airplane/pavement rating system replacing the various S, T, TT, LCN, AUW, ISWL, etc., rating systems used throughout the world. ACN is the Aircraft Classification Number and PCN is the Pavement Classification Number. An aircraft having an ACN equal to or less than the PCN can operate on the pavement subject to any limitation on the tire pressure. Numerically, the ACN is two times the derived single-wheel load expressed in thousands of kilograms, where the derived single wheel load is defined as the load on a single tire inflated to 181 psi (1.25 MPa) that would have the same pavement requirements as the

aircraft. Computationally, the ACN/PCN system uses the PCA program PDILB for rigid pavements and S-77-1 for flexible pavements to calculate ACN values.

The method of pavement evaluation is left up to the airport with the results of their evaluation presented as follows:

PCN	PAVEMENT TYPE	SUBGRADE CATEGORY	TIRE PRESSURE CATEGORY	EVALUATION METHOD
	R = Rigid	A = High	W = No Limit	T = Technical
	F = Flexible	B = Medium	X = To 254 psi (1.75 MPa)	U = Using Aircraft
		C = Low	Y = To 181 psi (1.25 MPa)	
		D = Ultra Low	Z = To 73 psi (0.5 MPa)	

ACN values for flexible pavements are calculated for the following four subgrade categories:

Code A - High Strength - CBR 15

Code B - Medium Strength - CBR 10

Code C - Low Strength - CBR 6

Code D - Ultra Low Strength - CBR 3

ACN values for rigid pavements are calculated for the following four subgrade categories:

Code A - High Strength, $k = 552.6 \text{ pci (150 MN/m}^3\text{)}$

Code B - Medium Strength, $k = 294.7 \text{ pci (80 MN/m}^3\text{)}$

Code C - Low Strength, $k = 147.4 \text{ pci (40 MN/m}^3\text{)}$

Code D - Ultra Low Strength, $k = 73.7 \text{ pci (20 MN/m}^3\text{)}$

7.2 LANDING GEAR FOOTPRINT

7.2.1 Landing Gear Footprint: Model 737-100

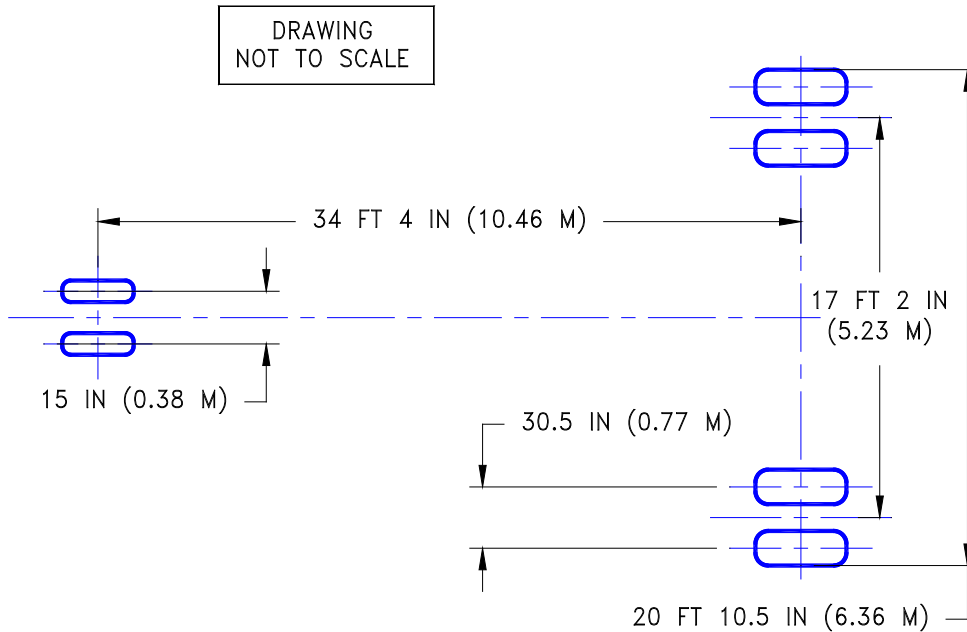

	UNITS	MODEL 737-100		
MAXIMUM DESIGN TAXI WEIGHT	LB	97,800	104,000	111,000
	KG	44,361	47,174	50,349
PERCENT OF WEIGHT ON MAIN GEAR	SEE SECTION 7.4			
NOSE GEAR TIRE SIZE	IN	24 x 7.7 – 10 14 PR		24 x 7.7 – 10 16 PR
NOSE GEAR TIRE PRESSURE	PSI	135	135	145
	MPa	0.93	0.93	1.00
MAIN GEAR TIRE SIZE	IN	40 x 14 – 16 22 PR	40 x 14 – 16 22 PR	40 x 14 – 16 24 PR
MAIN GEAR TIRE PRESSURE	PSI	138	146	157
	MPa	0.95	1.01	1.08

D6-58325-6

REV D

March 2023

7-3

7.2.2 Landing Gear Footprint: Model 737-200

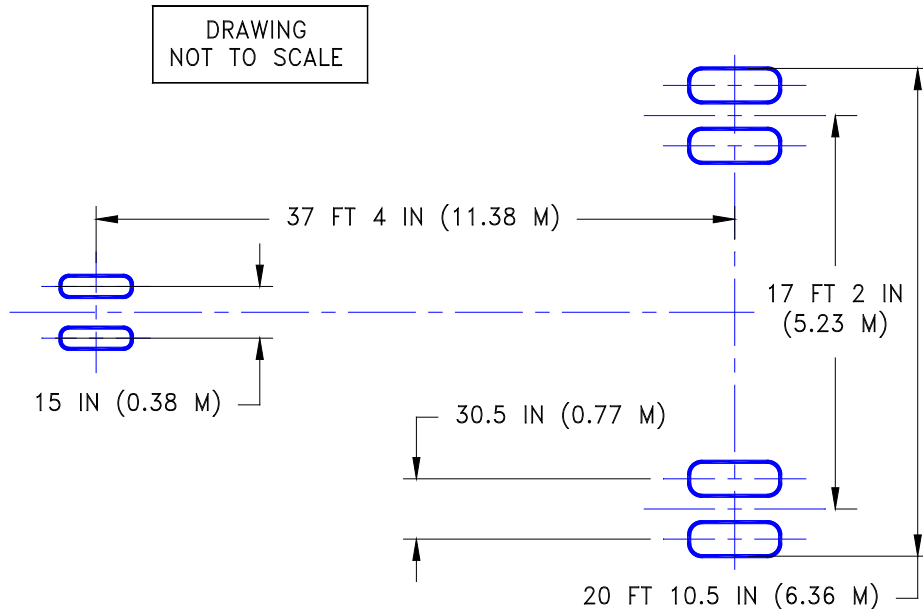

	UNITS	MODEL 737-200				
MAXIMUM DESIGN TAXI WEIGHT	LB	100,800	104,000	110,000	111,000	116,000
	KG	45,722	47,174	49,895	50,349	52,617
PERCENT OF WEIGHT ON MAIN GEAR	SEE SECTION 7.4					

STANDARD TIRES AND BRAKES

NOSE GEAR TIRE SIZE	IN	24 x 7.7 – 10 14 PR			24 x 7.7 – 10 16 PR	
NOSE GEAR TIRE PRESSURE	PSI	135	135	145	145	145
	MPa	0.93	0.93	1.00	1.00	1.00
MAIN GEAR TIRE SIZE	IN	40 x 14 – 16 22 PR			40 x 14 – 16 24 PR	
MAIN GEAR TIRE PRESSURE	PSI	141	146	156	157	158
	MPa	0.97	1.01	1.08	1.08	1.09

HEAVY-DUTY TIRES AND BRAKES

NOSE GEAR TIRE SIZE	IN	24 x 7.7 – 10 16 PR				
NOSE GEAR TIRE PRESSURE	PSI	145	145	145	145	145
	MPa	1.00	1.00	1.00	1.00	1.00
MAIN GEAR TIRE SIZE	IN	C40 X 14 – 21 22 PR			C40 X 14 – 21 24 PR	
MAIN GEAR TIRE PRESSURE	PSI	141	146	156	157	164
	MPa	0.97	1.01	1.08	1.08	1.13

D6-58325-6

REV D

March 2023

7-4

7.2.3 Landing Gear Footprint: Model Advanced 737-200

NOTE: SEE PREVIOUS PAGE FOR TIRE LAYOUT

	UNITS	MODEL 737-200				
MAXIMUM DESIGN TAXI WEIGHT	LB	116,000	117,500	120,000	125,000	128,600
	KG	52,617	53,297	54,431	56,699	58,332
PERCENT OF WEIGHT ON MAIN GEAR	SEE SECTION 7.4					

STANDARD TIRES AND BRAKES

NOSE GEAR TIRE SIZE	IN	24 x 7.7 – 10 16 PR			(NOT AVAILABLE)
NOSE GEAR TIRE PRESSURE	PSI	140			
	MPa	0.97			
MAIN GEAR TIRE SIZE	IN	40 x 14 – 16 24 PR			
MAIN GEAR TIRE PRESSURE	PSI	166	168	172	
	MPa	1.14	1.16	1.19	

HEAVY-DUTY TIRES AND BRAKES

NOSE GEAR TIRE SIZE	IN	24 x 7.7 – 10 16 PR			(NOT AVAILABLE)		
NOSE GEAR TIRE PRESSURE	PSI	140					
	MPa	0.97					
MAIN GEAR TIRE SIZE	IN	C40 X 14 – 21 24 PR		C40 X 14 – 21 26 PR OR H40 x 14.5 – 19 24 PR			
MAIN GEAR TIRE PRESSURE	PSI	164	166	170		178	182
	MPa	1.13	1.14	1.17		1.23	1.25

LOW PRESSURE TIRES

NOSE GEAR TIRE SIZE	IN	C24.5 x 18.5 – 12 12 PR	C24.5 x 18.5 – 12 12 PR	(NOT AVAILABLE)
NOSE GEAR TIRE PRESSURE	PSI	104	104	
	MPa	0.72	0.72	
MAIN GEAR TIRE SIZE	IN	C40 X 18 - 17 20 PR	C40 X 18 - 17 20 PR	
MAIN GEAR TIRE PRESSURE	PSI	95	96	
	MPa	0.66	0.66	

7.2.4 Landing Gear Footprint: Model Advanced 737-300, -400, -500

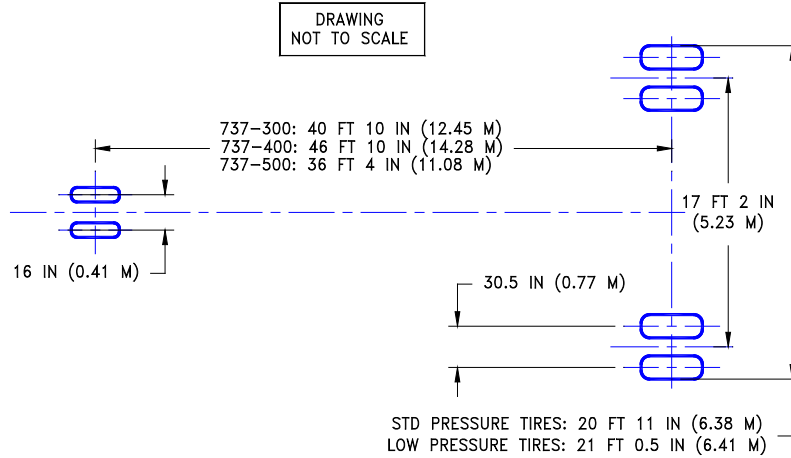

	UNITS	737-300	737-400				737-500
MAXIMUM DESIGN TAXI WEIGHT	LB	125,000 TO 140,000	139,000	143,000	144,000	150,500	116,000 TO 134,000
	KG	56,699 TO 63,503	63,049	64,864	65,317	68,266	52,617 TO 60,781
PERCENT OF WEIGHT ON MAIN GEAR	SEE SECTION 7.4						

STANDARD TIRES AND BRAKES

NOSE GEAR TIRE SIZE	IN	27 x 7.75 – 15 10 PR	27 x 7.75 – 15 12 PR				27 x 7.75 – 15 12 PR
NOSE GEAR TIRE PRESSURE	PSI	166	171	172	173	177	186
	MPa	1.14	1.18	1.19	1.19	1.22	1.28
MAIN GEAR TIRE SIZE	IN	H40 x 14.5 – 19 24 PR	H40 x 14.5 – 19 26 PR		H42 x 16 – 19 26 PR	H40 x 14.5 – 19 24 PR	
MAIN GEAR TIRE PRESSURE (1)	PSI	180 TO 201	203	209	211	185	170 TO 194
	MPa	1.24 TO 1.39	1.40	1.44	1.45	1.28	1.17 TO 1.34

LOW PRESSURE TIRES

NOSE GEAR TIRE SIZE	IN	24 x 7.75 – 15 10 PR	24 x 7.75 – 15 12 PR				24 x 7.75 – 15 12 PR
NOSE GEAR TIRE PRESSURE	PSI	166	171	172	173	(NA)	186
	MPa	1.14	1.18	1.19	1.19	(NA)	1.28
MAIN GEAR TIRE SIZE	IN	H42 X 16 – 19 24 PR	H42 X 16 – 19 24 PR			(NA)	H42 X 16 – 19 24 PR
MAIN GEAR TIRE PRESSURE (1)	PSI	152 TO 170	171	176	177	(NA)	144 TO 164
	MPa	1.05 TO 1.17	1.18	1.21	1.22	(NA)	0.99 TO 1.13

NOTE: 1. SEE SEC 7.11 - TIRE INFLATION CHART, FOR TIRE PRESSURES AT INTERMEDIATE WEIGHTS.

7.3 MAXIMUM PAVEMENT LOADS

7.3.1 Maximum Pavement Loads: Model 737-100, -200

V_{NG} = MAXIMUM VERTICAL NOSE GEAR GROUND LOAD AT MOST FORWARD CENTER OF GRAVITY

V_{MG} = MAXIMUM VERTICAL MAIN GEAR GROUND LOAD AT MOST AFT CENTER OF GRAVITY

H = MAXIMUM HORIZONTAL GROUND LOAD FROM BRAKING

NOTE: ALL LOADS CALCULATED USING AIRPLANE MAXIMUM DESIGN TAXI WEIGHT

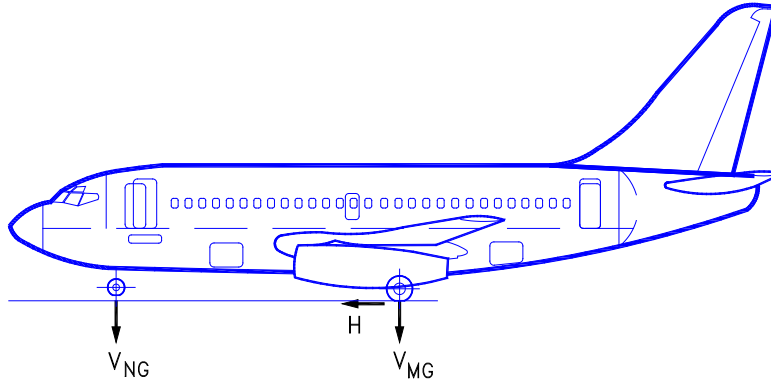

AIRPLANE MODEL	UNITS	MAX DESIGN TAXI WEIGHT	V_{NG}		V_{MG} PER STRUT AT MAX LOAD AT STATIC AFT C.G.	H PER STRUT	
			STATIC AT MOST FWD C.G.	STATIC + BRAKING 10 FT/SEC ² DECEL		STEADY BRAKING 10 FT/SEC ² DECEL	AT INSTANTANEOUS BRAKING ($\mu = 0.8$)
737-100	LB	97,800	14,000	21,500	45,200	15,100	36,200
	KG	44,362	6,350	9,752	20,503	6,849	16,420
737-100,-200	LB	104,000	18,200	24,000	48,000	16,100	38,400
	KG	47,174	8,255	10,886	21,773	7,303	17,418
737-200,200	LB	111,000	17,700	25,600	51,000	17,300	40,800
	KG	50,349	8,029	11,612	23,133	7,847	18,507
737-200, 200C	LB	116,000	16,500	25,200	52,800	18,000	42,200
	KG	52,617	7,484	11,431	23,950	8,165	19,142
737-200, 200C	LB	117,500	15,800	23,500	54,500	18,200	43,600
	KG	53,298	7,167	10,660	24,721	8,255	19,777
737-200	LB	100,800	14,700	21,400	46,800	13,800	37,500
	KG	45,723	6,668	9,707	21,228	6,260	17,010
737-200	LB	110,000	16,100	24,000	51,000	17,000	40,800
	KG	49,896	7,303	10,886	23,133	7,711	18,507
737-200, 200C	LB	120,000	16,500	24,500	55,600	16,800	44,500
	KG	54,432	7,484	11,113	25,220	7,620	20,185
737-200, 200C	LB	125,000	16,400	24,700	57,900	19,400	46,300
	KG	56,700	7,439	11,204	26,263	8,800	21,002
737-200, 200C	LB	128,600	14,200	22,800	59,100	20,000	47,300
	KG	58,333	6,441	10,342	26,808	9,072	21,455

7.3.2 Maximum Pavement Loads: Model 737-300, -400, -500

V_{NG} = MAXIMUM VERTICAL NOSE GEAR GROUND LOAD AT MOST FORWARD CENTER OF GRAVITY

V_{MG} = MAXIMUM VERTICAL MAIN GEAR GROUND LOAD AT MOST AFT CENTER OF GRAVITY

H = MAXIMUM HORIZONTAL GROUND LOAD FROM BRAKING

NOTE: ALL LOADS CALCULATED USING AIRPLANE MAXIMUM DESIGN TAXI WEIGHT

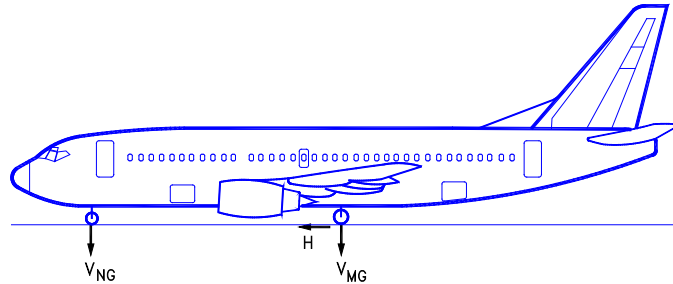

AIRPLANE MODEL	UNITS	MAX DESIGN TAXI WEIGHT	V_{NG}		V_{MG} PER STRUT AT MAX LOAD AT STATIC AFT C.G.	H PER STRUT	
			STATIC AT MOST FWD C.G.	STATIC + BRAKING 10 FT/SEC ² DECEL		STEADY BRAKING 10 FT/SEC ² DECEL	AT INSTANTANEOUS BRAKING ($\mu = 0.8$)
737-300	LB	125,000	154,000	22,700	58,300	19,400	46,600
	KG	56,700	69,854	10,297	26,445	8,800	21,138
737-300	LB	130,500	15,300	23,100	60,600	20,300	48,500
	KG	59,194	6,940	10,478	27,488	9,208	21,999
737-300	LB	135,500	15,200	23,400	62,200	21,000	49,800
	KG	61,462	6,895	10,614	28,214	9,526	22,589
737-300	LB	137,500	15,600	24,300	63,200	21,400	50,500
	KG	62,370	7,076	11,022	28,667	9,707	22,907
737-300	LB	139,000	15,600	24,400	63,600	21,600	50,900
	KG	63,050	7,076	11,068	28,849	9,798	23,088
737-300	LB	140,000	14,500	23,400	63,600	21,700	50,900
	KG	63,504	6,577	10,614	28,849	9,843	23,088
737-400	LB	139,000	15,900	23,000	64,900	21,600	51,900
	KG	63,050	7,212	10,433	29,438	9,798	23,542
737-400	LB	143,000	16,000	20,800	67,100	22,200	53,700
	KG	64,864	7,258	9,435	30,436	10,070	24,358
737-400	LB	144,000	12,200	19,700	66,900	22,400	56,500
	KG	65,318	5,534	8,936	30,346	10,161	25,628
737-400	LB	150,500	16,500	24,400	70,600	23,400	56,500
	KG	68,266	7,484	11,068	32,024	10,614	25,628
737-500	LB	116,000	17,100	25,000	53,700	18,000	42,900
	KG	52,617	7,757	11,340	24,358	8,165	19,459
737-500	LB	125,000	17,300	25,800	57,700	19,400	46,200
	KG	56,700	7,847	11,703	26,173	8,800	20,956
737-500	LB	134,000	17,300	26,400	61,800	20,800	49,400
	KG	60,781	7,847	11,975	28,032	9,435	22,407

7.4 LANDING GEAR LOADING ON PAVEMENT

7.4.1 Landing Gear Loading on Pavement: Model 737-100

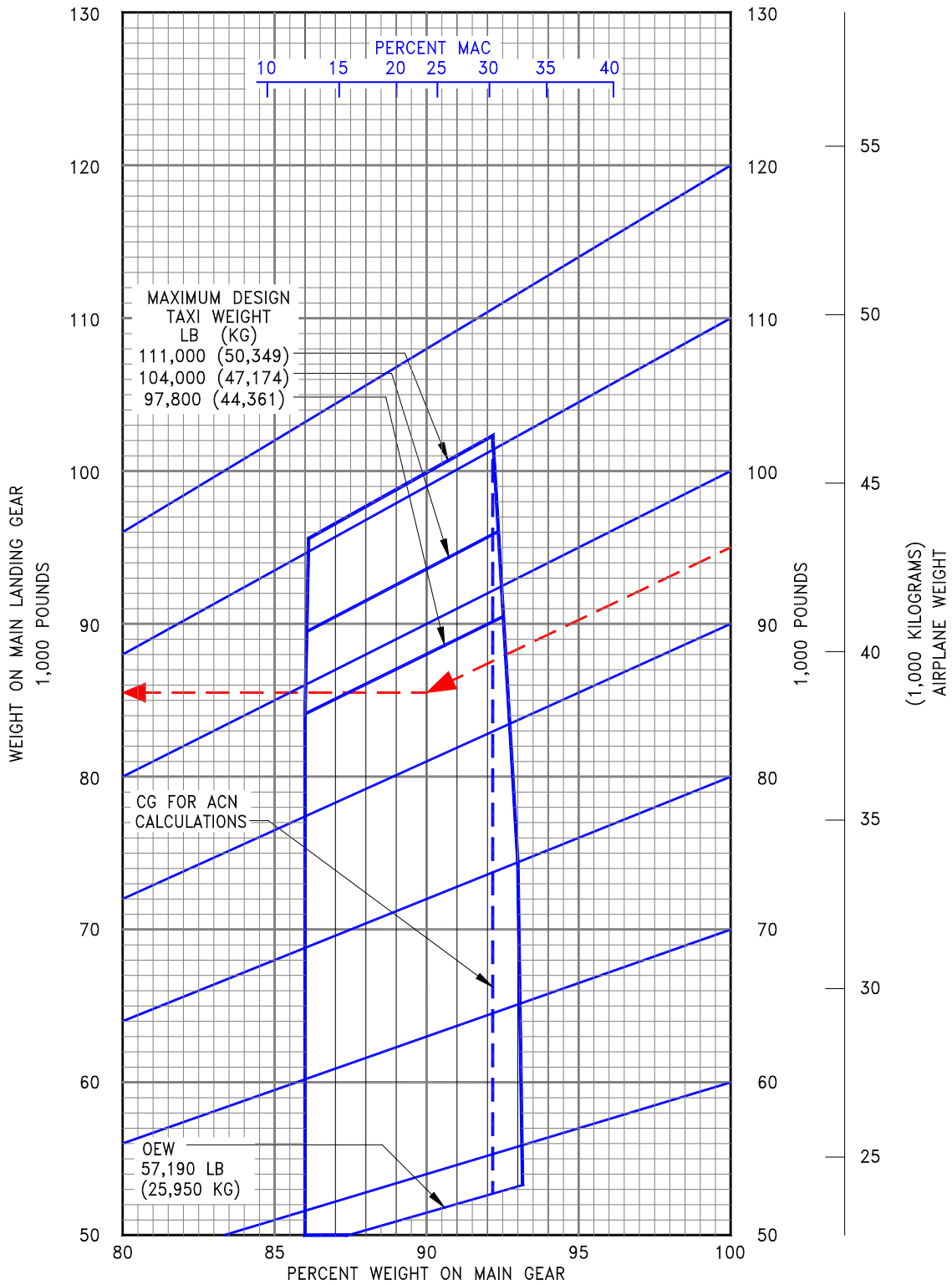

D6-58325-6

REV D

March 2023

7-9

7.4.2 Landing Gear Loading on Pavement: Model 737-200

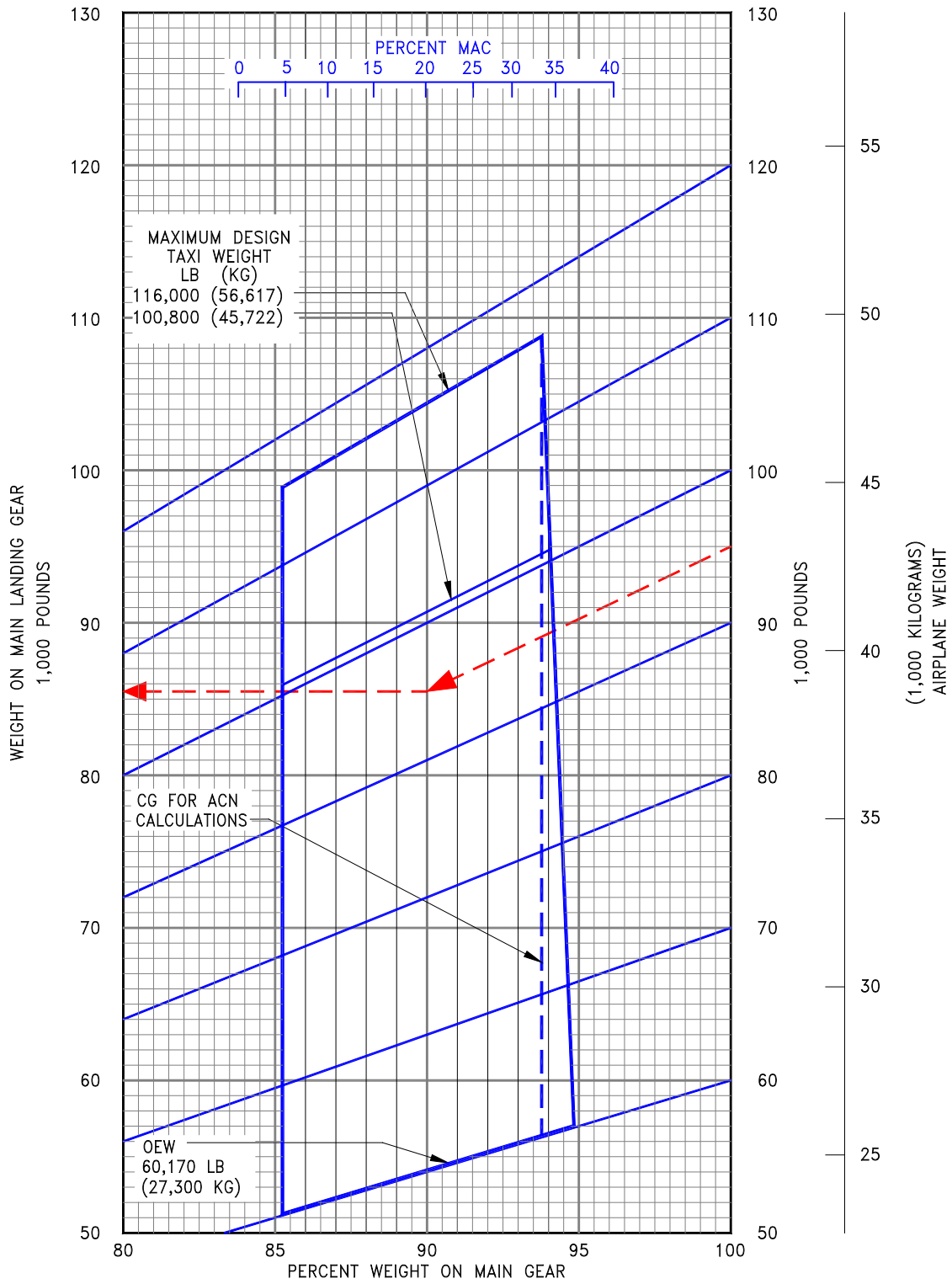

D6-58325-6

7.4.3 Landing Gear Loading on Pavement: Model 737-200 Advanced

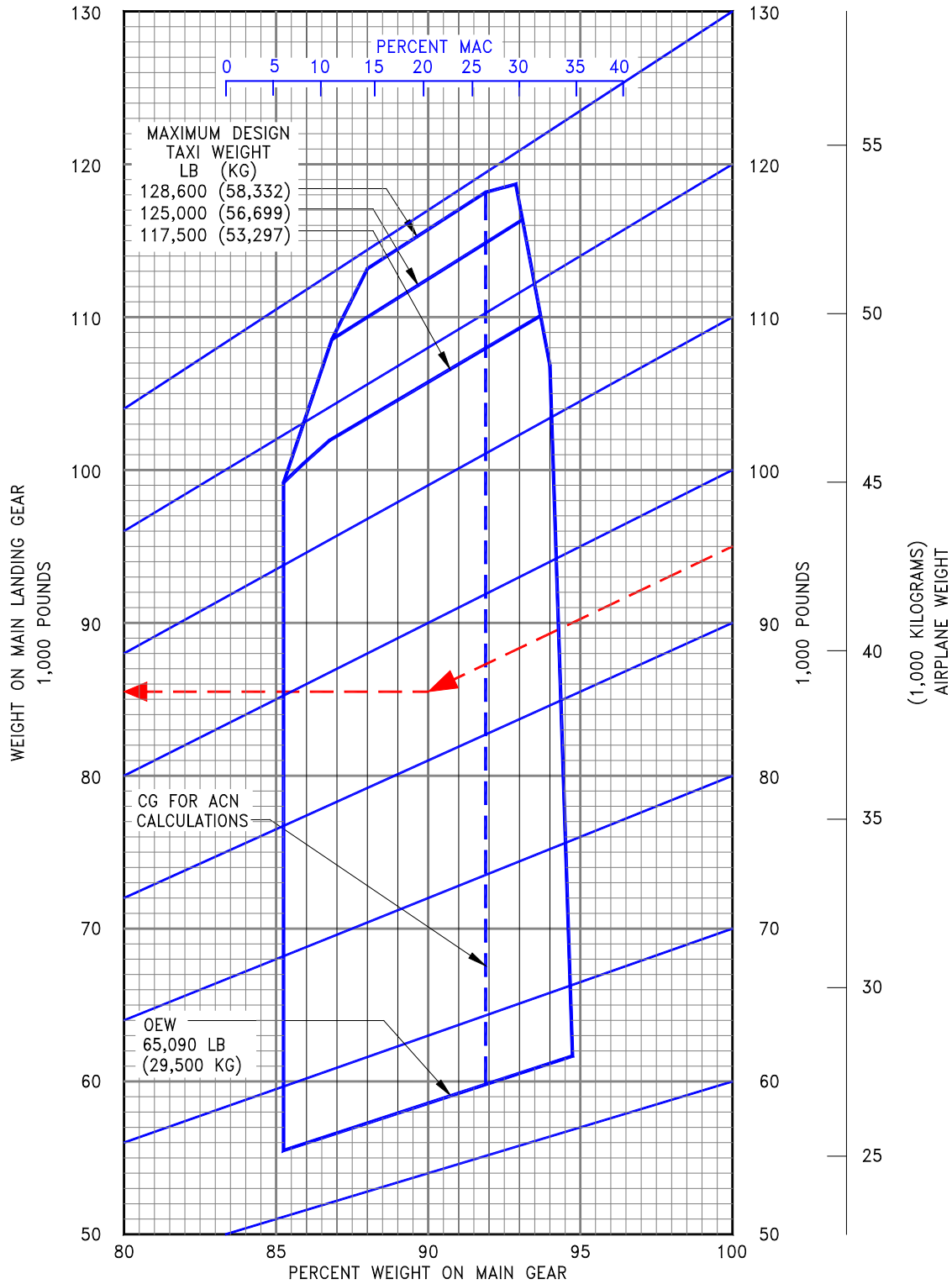

D6-58325-6

7.4.4 Landing Gear Loading on Pavement: Model 737-300

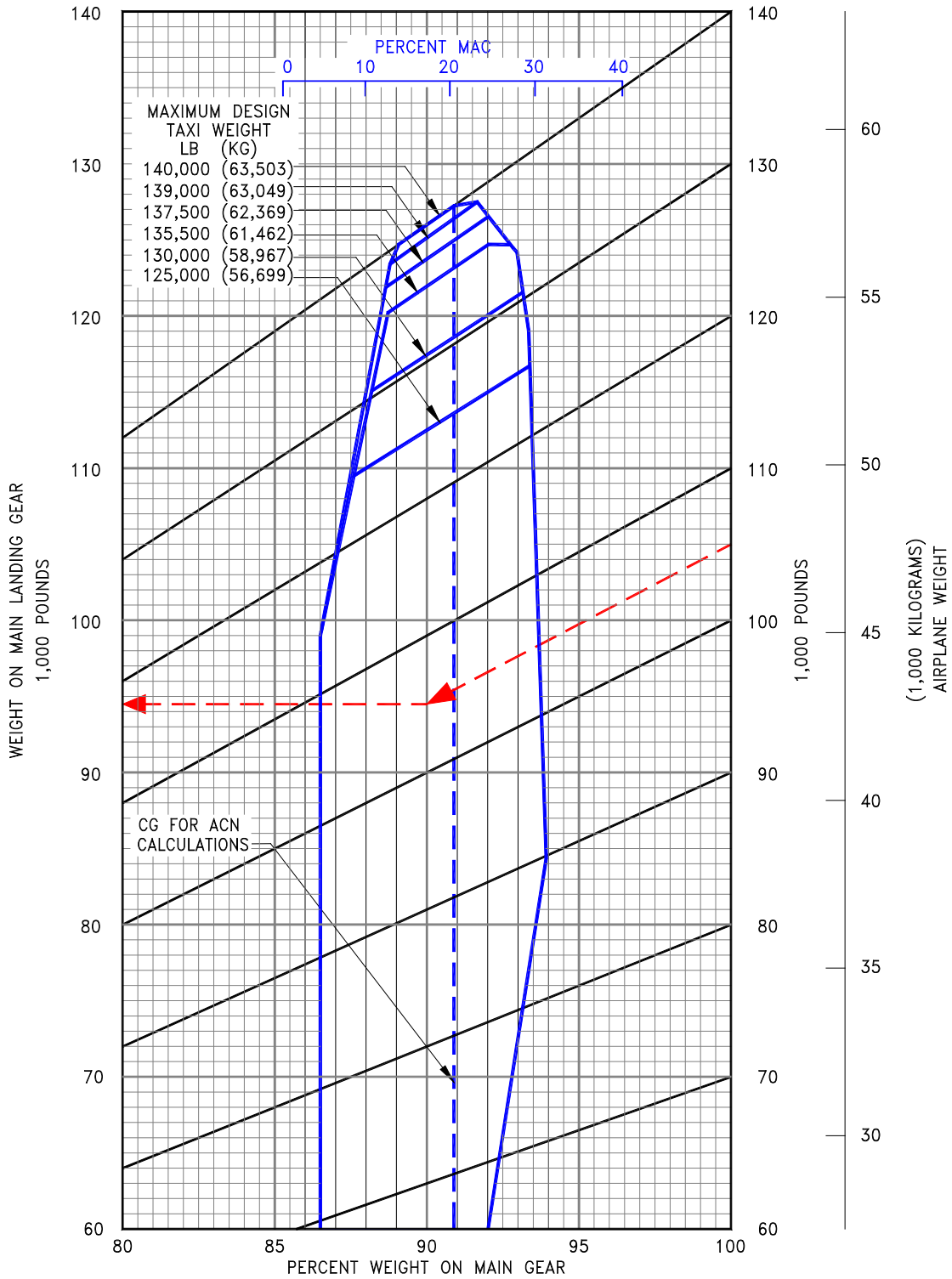

D6-58325-6

7.4.5 Landing Gear Loading on Pavement: Model 737-400

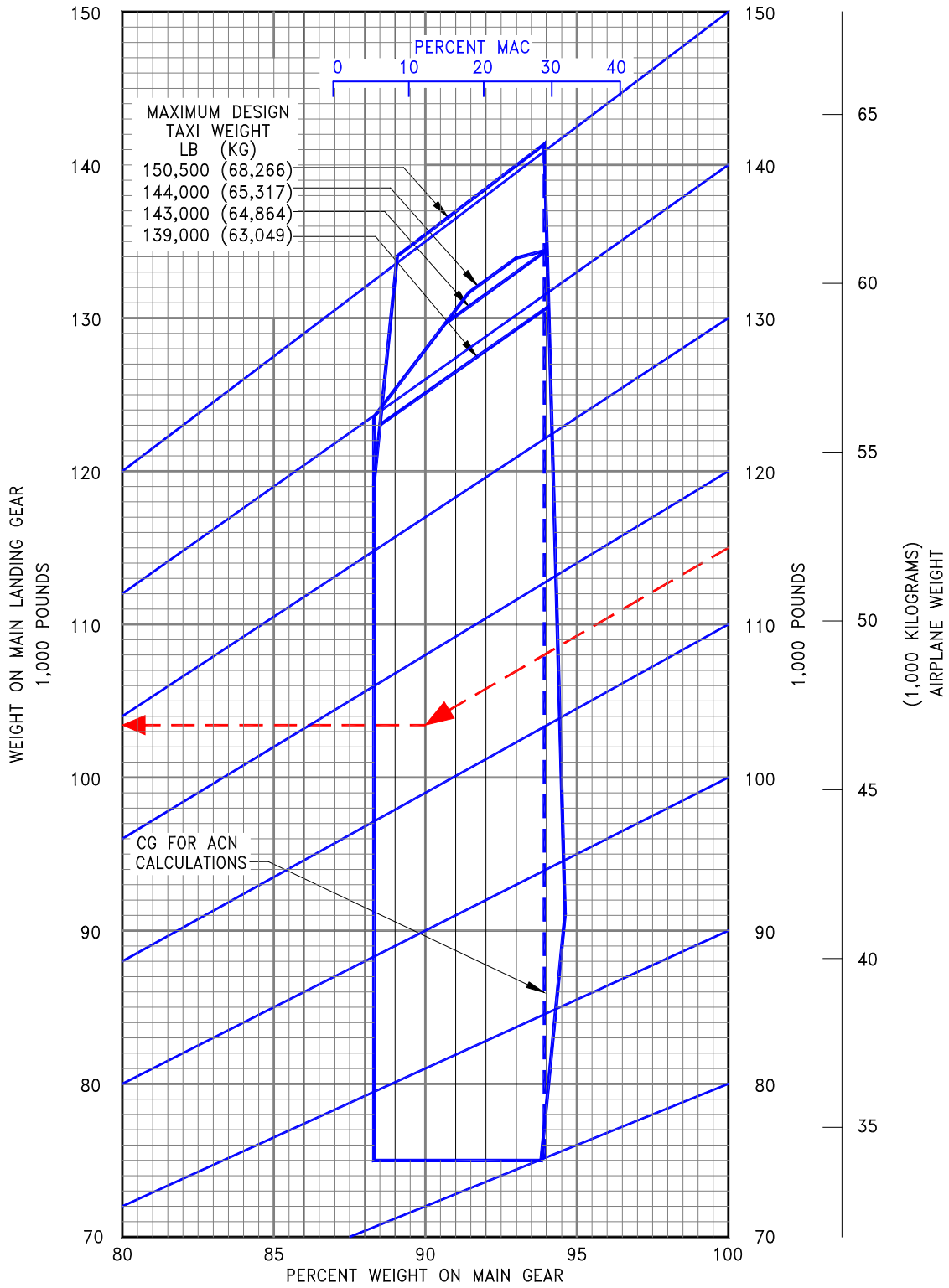

D6-58325-6

7.4.6 Landing Gear Loading on Pavement: 737-500

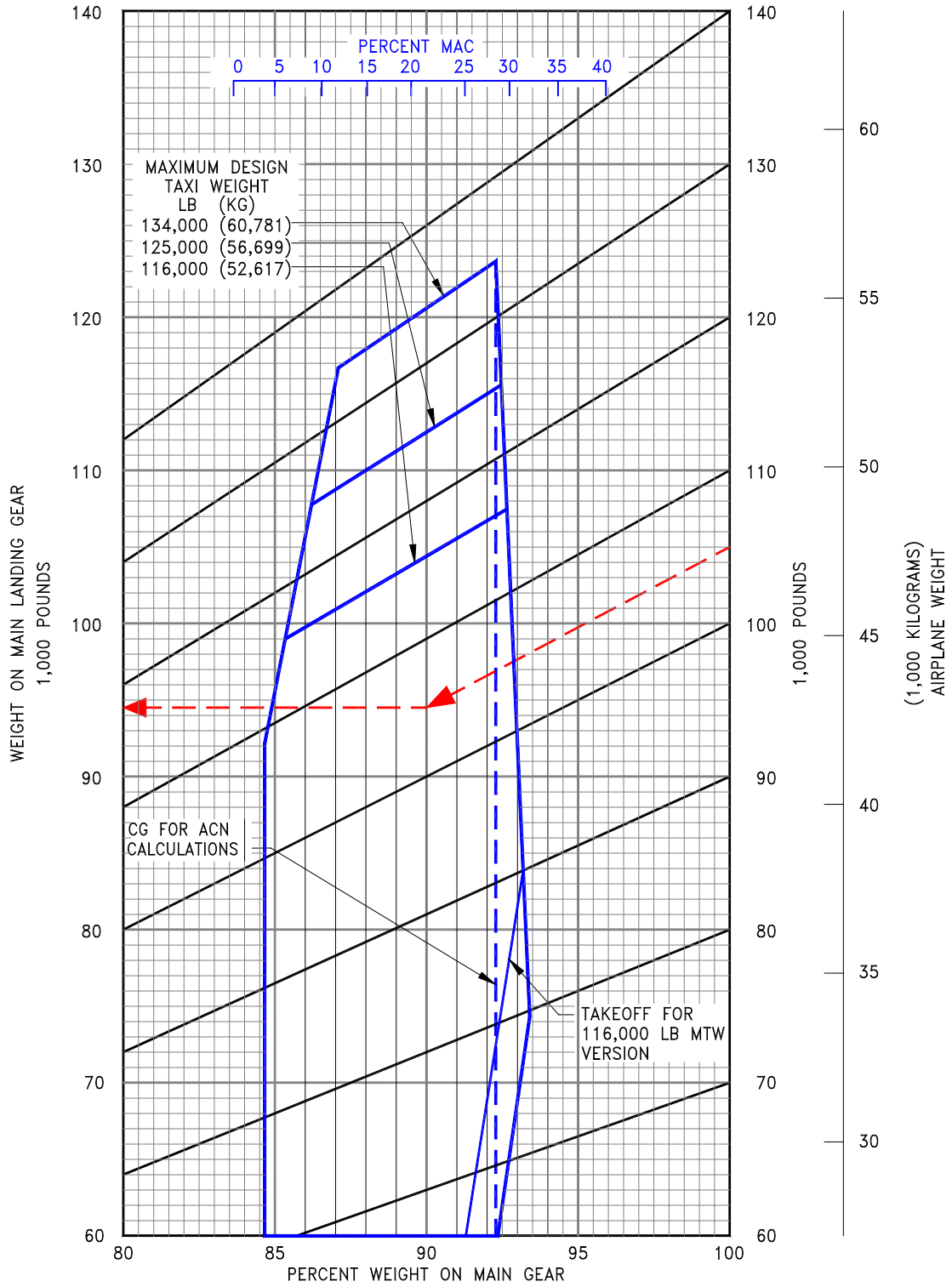

D6-58325-6

7.5 FLEXIBLE PAVEMENT REQUIREMENTS - U.S. ARMY CORPS OF ENGINEERS METHOD S-77-1 AND FAA DESIGN METHOD

The following flexible-pavement design chart presents the data of five incremental main-gear loads at the minimum tire pressure required at the maximum design taxi weight.

In the example shown in the next page, for a CBR of 25 and an annual departure level of 10,000, the required flexible pavement thickness for an airplane with a main gear loading of 85,000 pounds is 8.2 inches. Similar examples are shown in succeeding charts.

The line showing 10,000 coverages is used for ACN calculations (see Section 7.10).

The FAA design method uses a similar procedure using total airplane weight instead of weight on the main landing gears. The equivalent main gear loads for a given airplane weight could be calculated from Section 7.4. For the flexible pavement design refer to the FAA AC 150/5320-6 "Airport Pavement Design and Evaluation" and pavement design program FAARFIELD. Both are available on the FAA website:

FAA AC 150/5320-6F: https://www.faa.gov/airports/resources/advisory_circulars/

FAARFIELD: https://www.faa.gov/airports/engineering/design_software/

7.5.1 Flexible Pavement Requirements - U.S. Army Corps of Engineers Design Method (S-77-1) and FAA Design Method: Model 737-100, -200 to 104,000 LB (47,170 KG) MTW

NOTES:

- * TIRES - 40 x 14 - 16 28 PR; C40 x 14 - 21 22 PR
- * PRESSURE RANGE FROM 138 TO 146 PSI (9.70 TO 10.27 KG/SC CM)

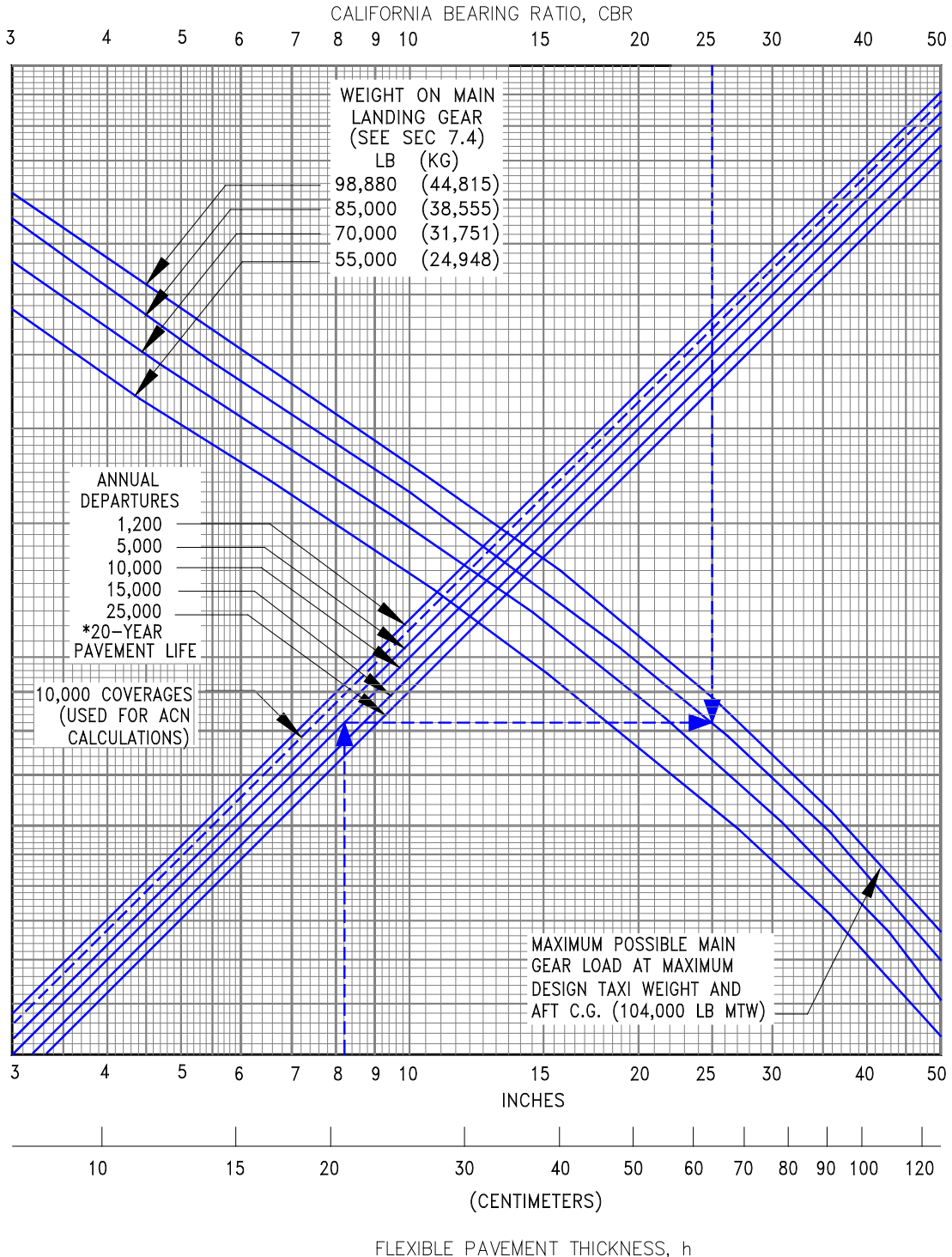

D6-58325-6

REV D

March 2023

7-16

7.5.2 Flexible Pavement Requirements - U.S. Army Corps of Engineers Design Method (S-77-1) and FAA Design Method: Model 737-100, -200, -200 ADV at 110,000 to 117,500 LB (49,895 to 53,297 KG) MTW

NOTES:

- * TIRES - 40 x 14 - 16 24 PR; C40 x 14 - 21 24 PR
- * PRESSURE RANGE FROM 156 TO 168 PSI (10.97 TO 11.81 KG/SC CM)

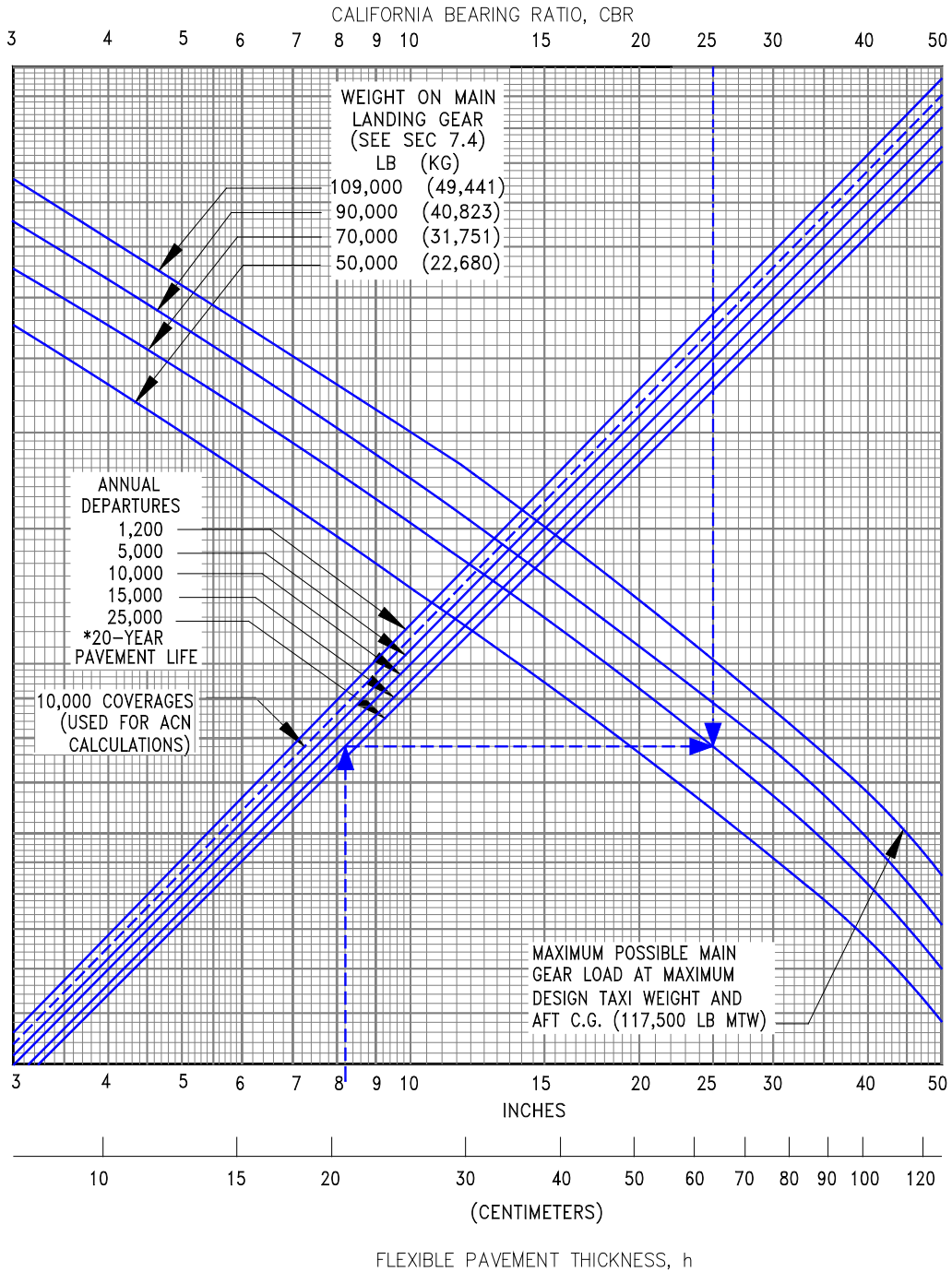

D6-58325-6

REV D

March 2023

7-17

7.5.3 Flexible Pavement Requirements - U.S. Army Corps of Engineers Design Method (S-77-1) and FAA Design Method: Model 737-200 ADV at 116,000 to 117,500 LB (52,617 to 53,297 KG) MTW, Low Pressure Tires

NOTES:

- * TIRES - C40 x 18 - 17 20 PR
- * PRESSURE RANGE AT 95 OR 96 PSI (6.68 OR 6.75 KG/SC CM)

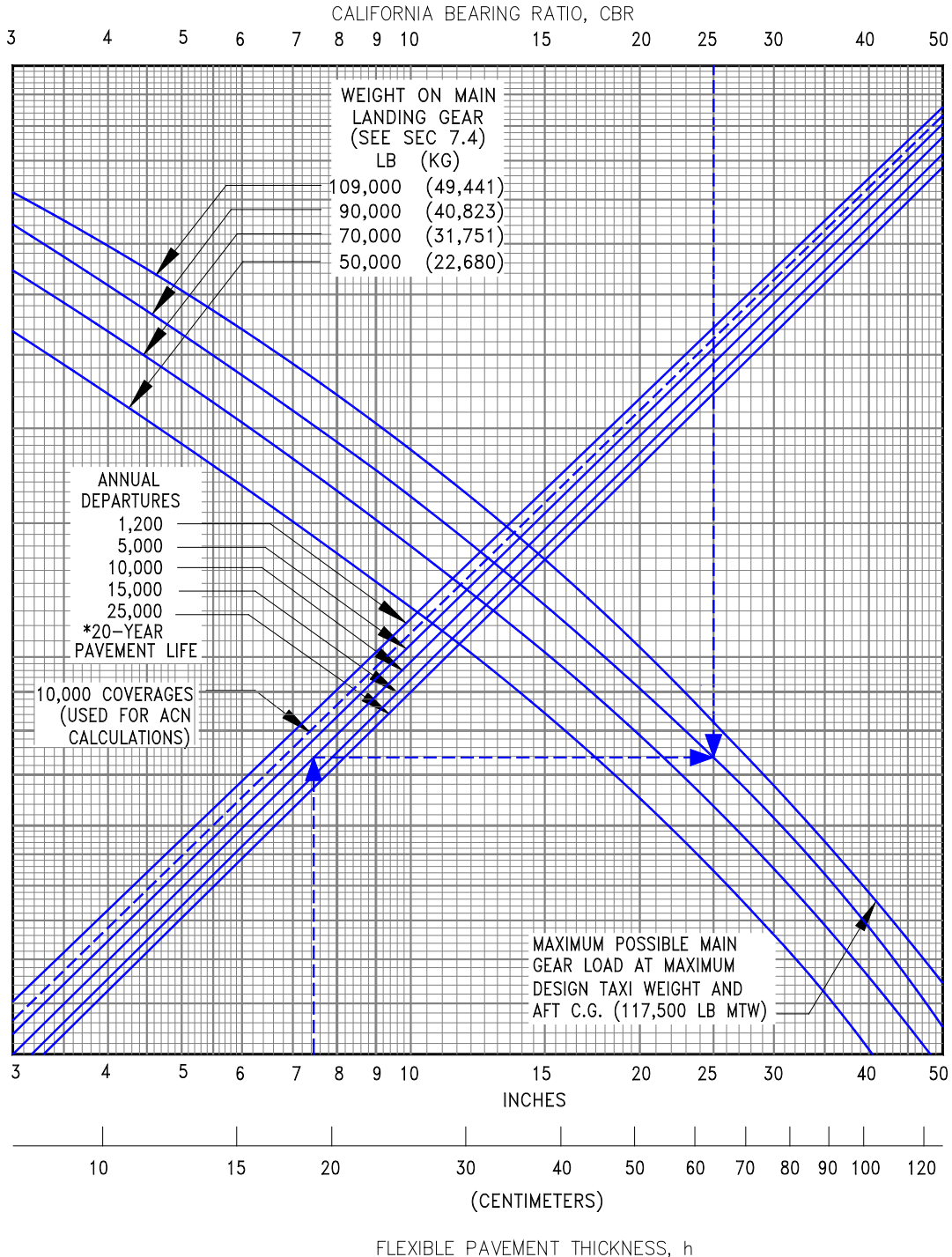

D6-58325-6

7.5.4 Flexible Pavement Requirements - U.S. Army Corps of Engineers Design Method (S-77-1) and FAA Design Method: Model 737-200 ADV at 120,000 to 128,600 LB (54,431 to 58,332 KG) MTW

NOTES:

- * TIRES - C40 x 18 - 17 20 PR
- * PRESSURE RANGE AT 95 OR 96 PSI (6.68 OR 6.75 KG/SC CM)

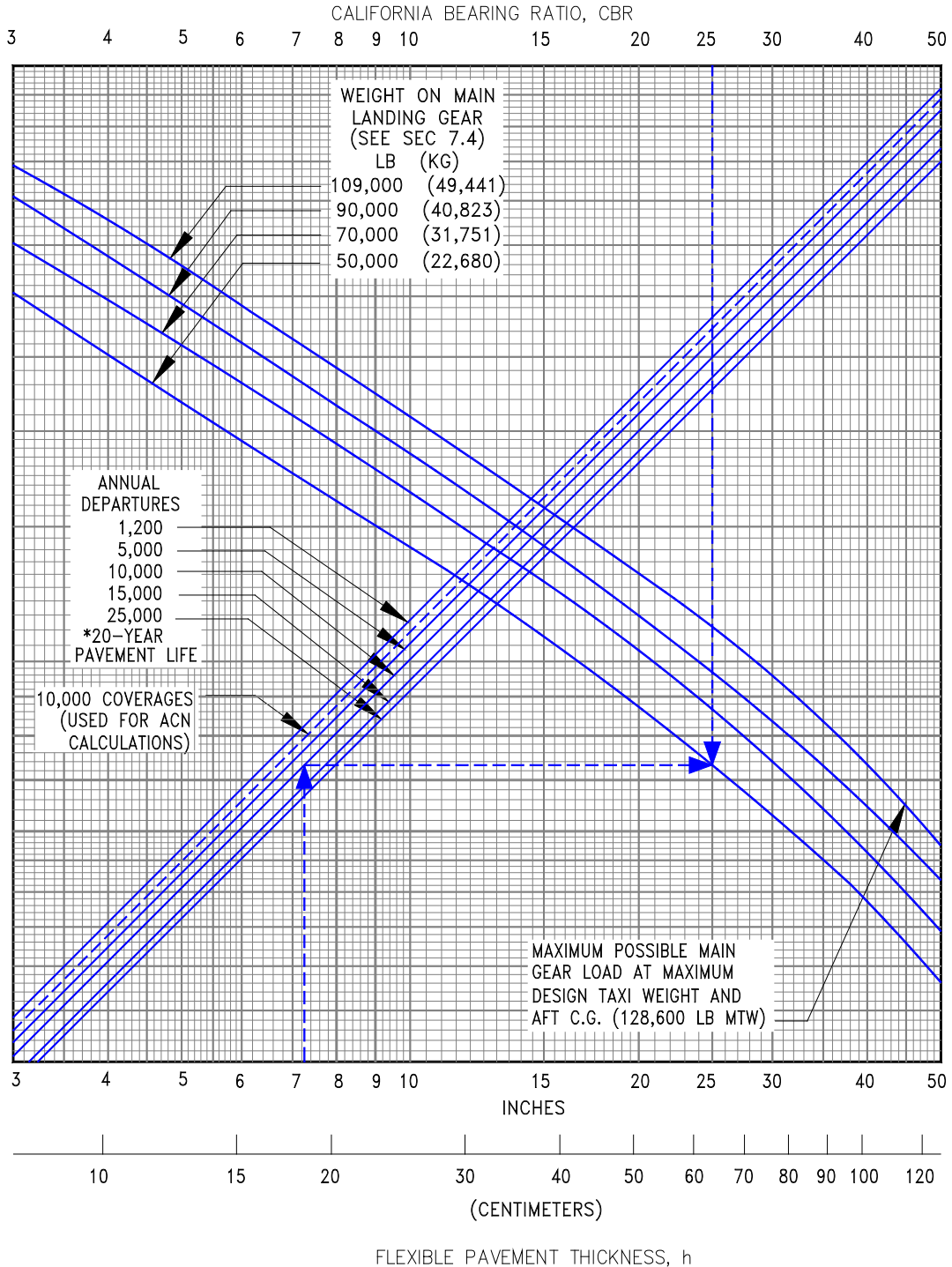

D6-58325-6

REV D

March 2023

7-19

7.5.5 Flexible Pavement Requirements - U.S. Army Corps of Engineers Design Method (S-77-1) and FAA Design Method: Model 737-300, -400, -500

NOTE:

* TIRES - H40 x 14.5 - 19 24 PR, 26 PR, H42 x 16-19 24 PR, 26 PR

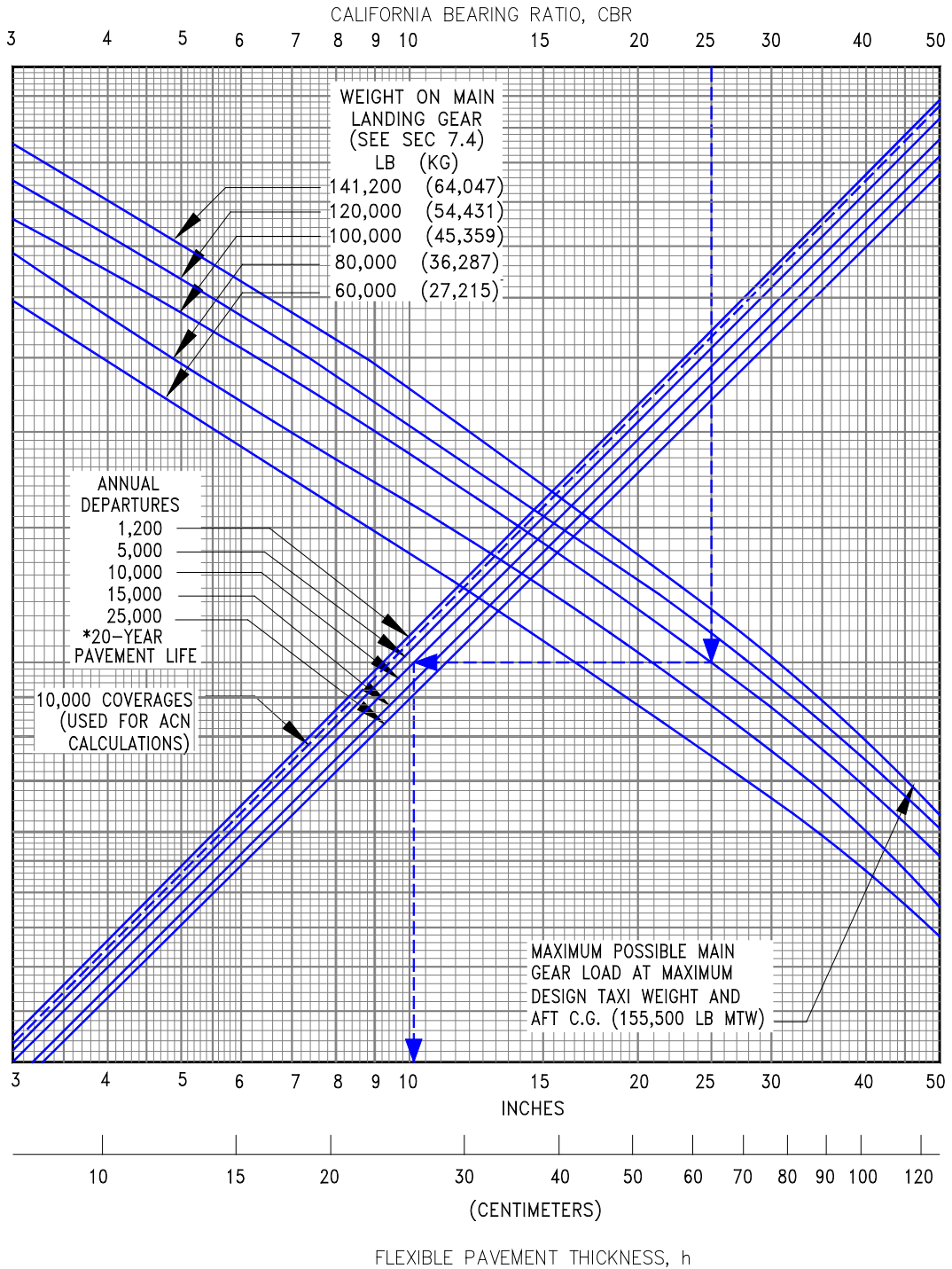

D6-58325-6

REV D

March 2023

7-20

7.6 FLEXIBLE PAVEMENT REQUIREMENTS - LCN CONVERSION

To determine the airplane weight that can be accommodated on a particular flexible pavement, both the Load Classification Number (LCN) of the pavement and the thickness must be known.

In the example shown on the next page, flexible pavement thickness is shown at 23.75 in. with an LCN of 42. For these conditions, the apparent maximum allowable weight permissible on the main landing gear is 85,000 lb for an airplane with 138 to 146-psi main gear tires. Similar examples are shown in succeeding charts.

Note: If the resultant aircraft LCN is not more than 10% above the published pavement LCN, the bearing strength of the pavement can be considered sufficient for unlimited use by the airplane. The figure 10% has been chosen as representing the lowest degree of variation in LCN that is significant (reference: ICAO Aerodrome Manual, Part 2, "Aerodrome Physical Characteristics," Chapter 4, Paragraph 4.1.5.7v, 2nd Edition dated 1965).

7.6.1 Flexible Pavement Requirements - LCN Method: Model 737-100, -200 at 140,000 LB (47,174 KG) MTW

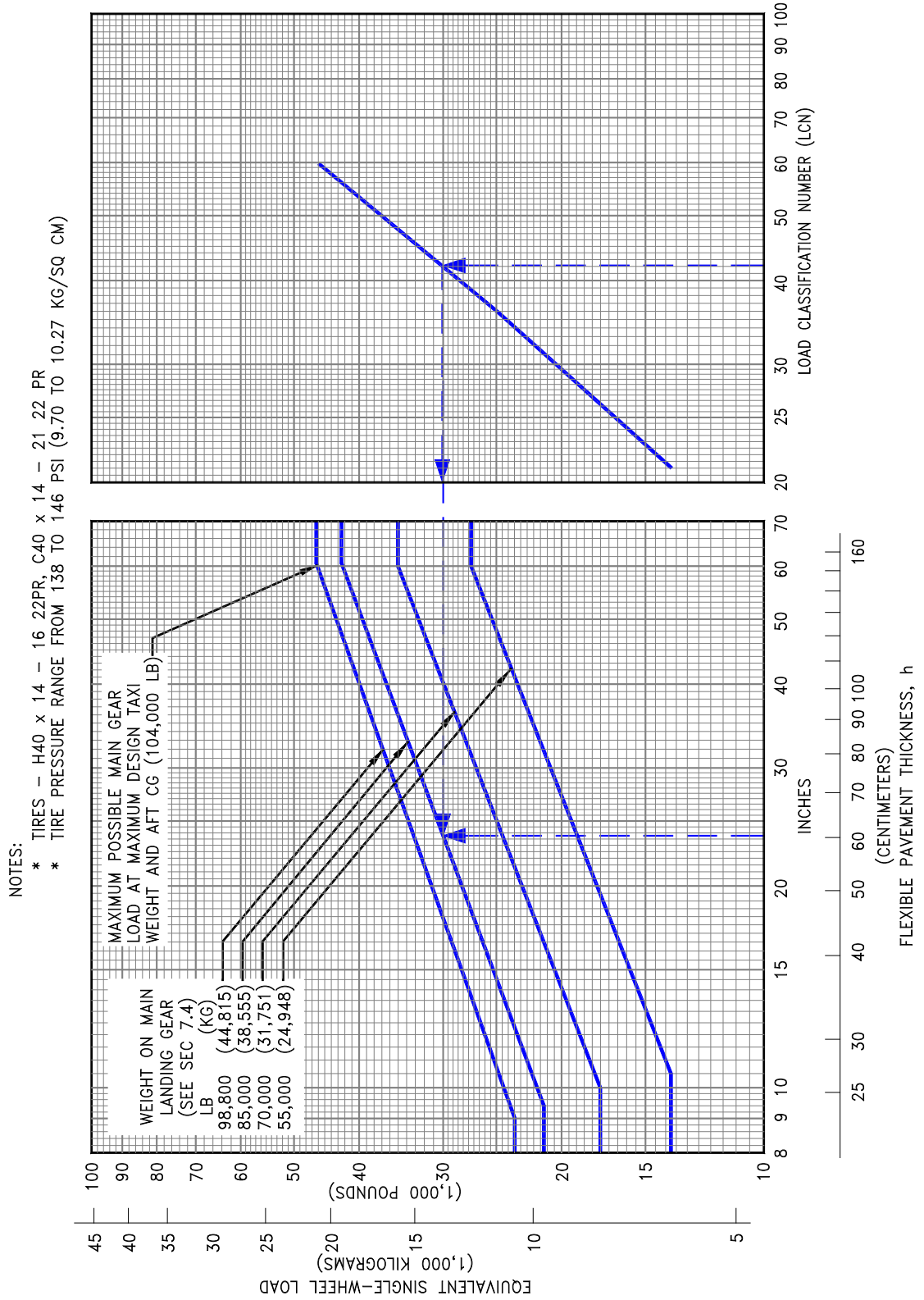

D6-58325-6

7.6.2 Flexible Pavement Requirements - LCN Method: Model 737-100, -200, -200 ADV at 110,000 to 117,500 LB (49,895 to 53,297 KG) MTW

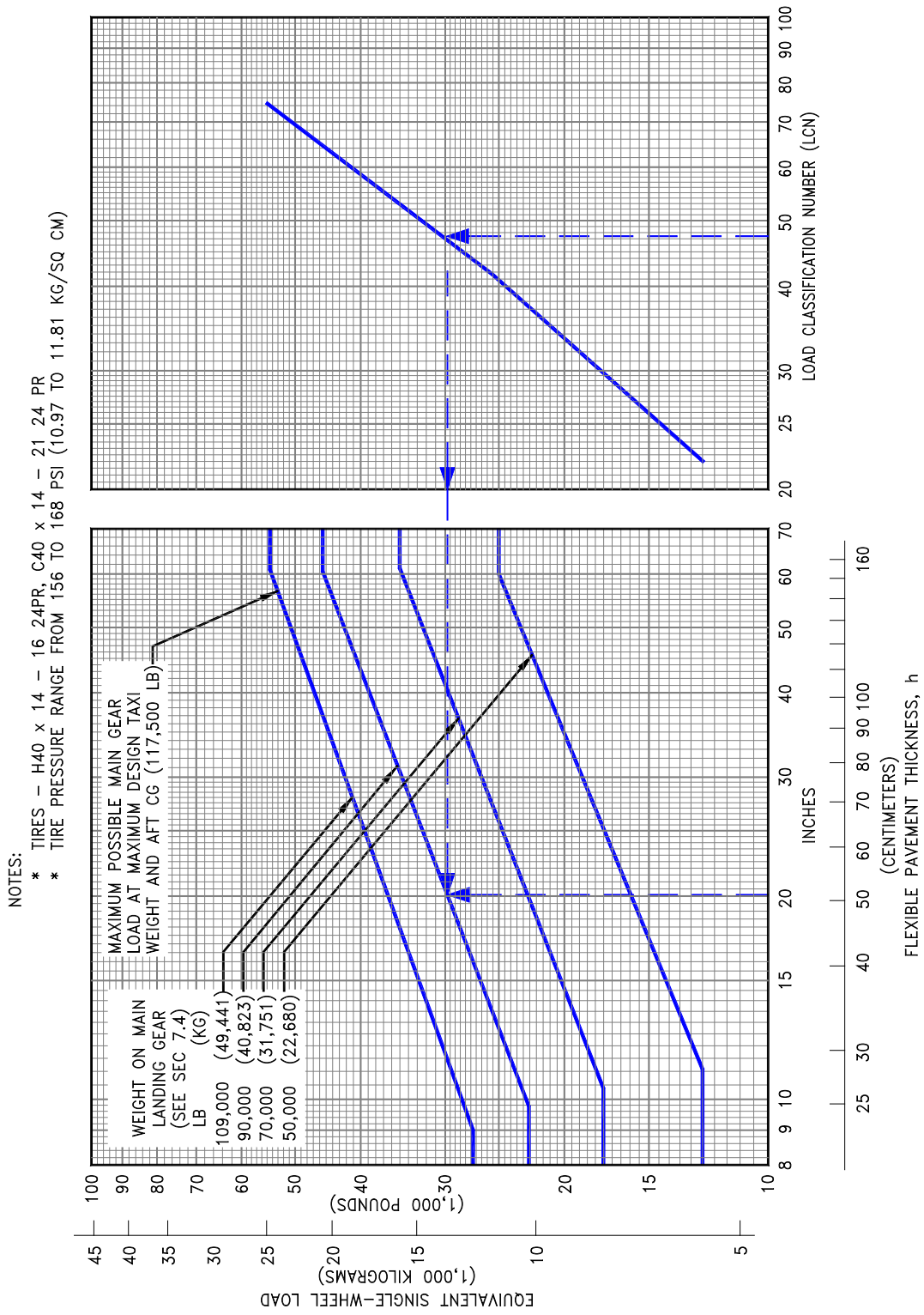

D6-58325-6

REV D

March 2023

7-23

7.6.3 Flexible Pavement Requirements - LCN Method: Model 737-200 ADV at 116,000 to 117,500 LB (52,617 to 53,297 KG) MTW, Low Pressure Tires

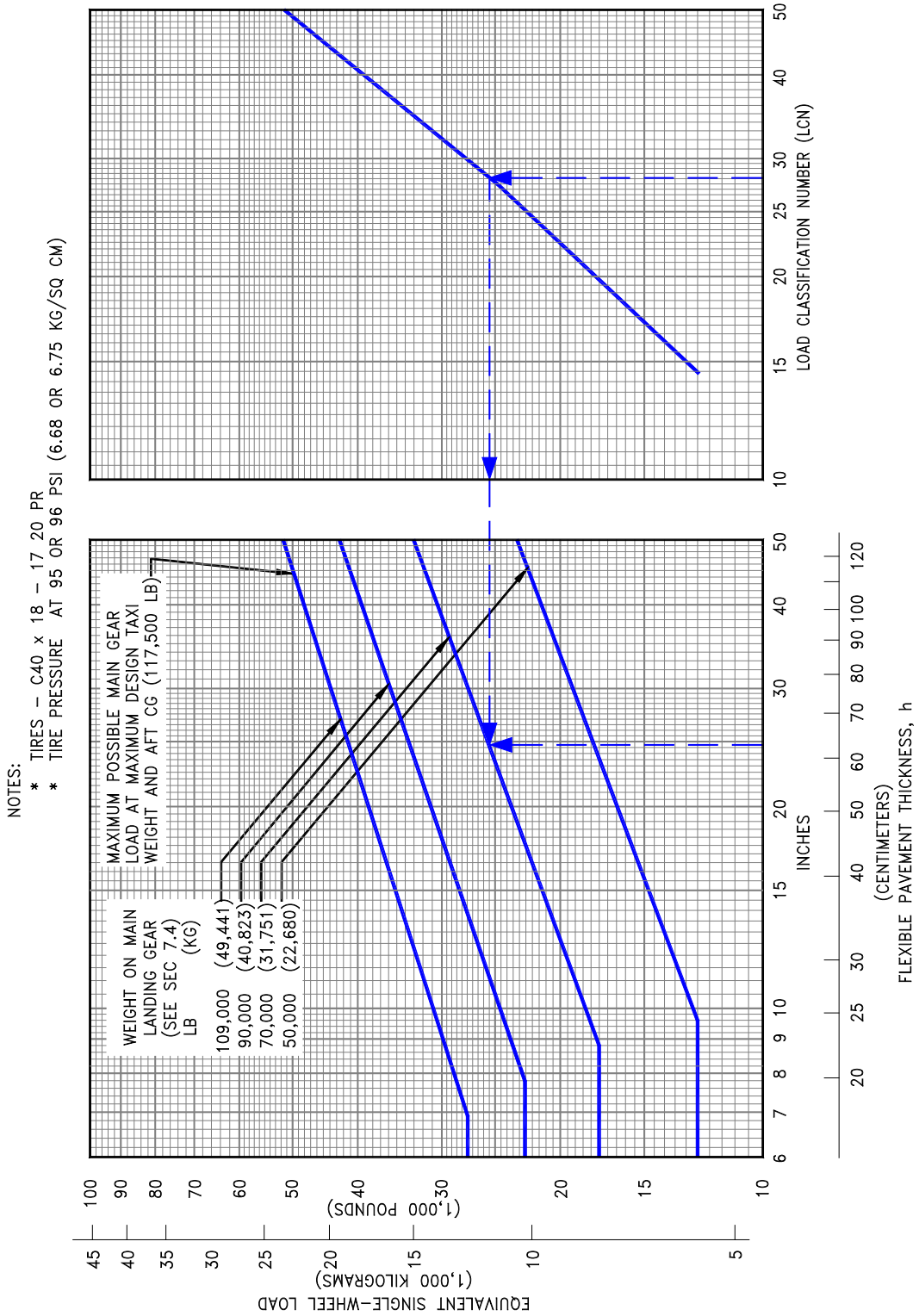

D6-58325-6

7.6.4 Flexible Pavement Requirements - LCN Method: Model 737-200 ADV at 120,000 to 128,600 LB (54,431 to 58,332 KG) MTW

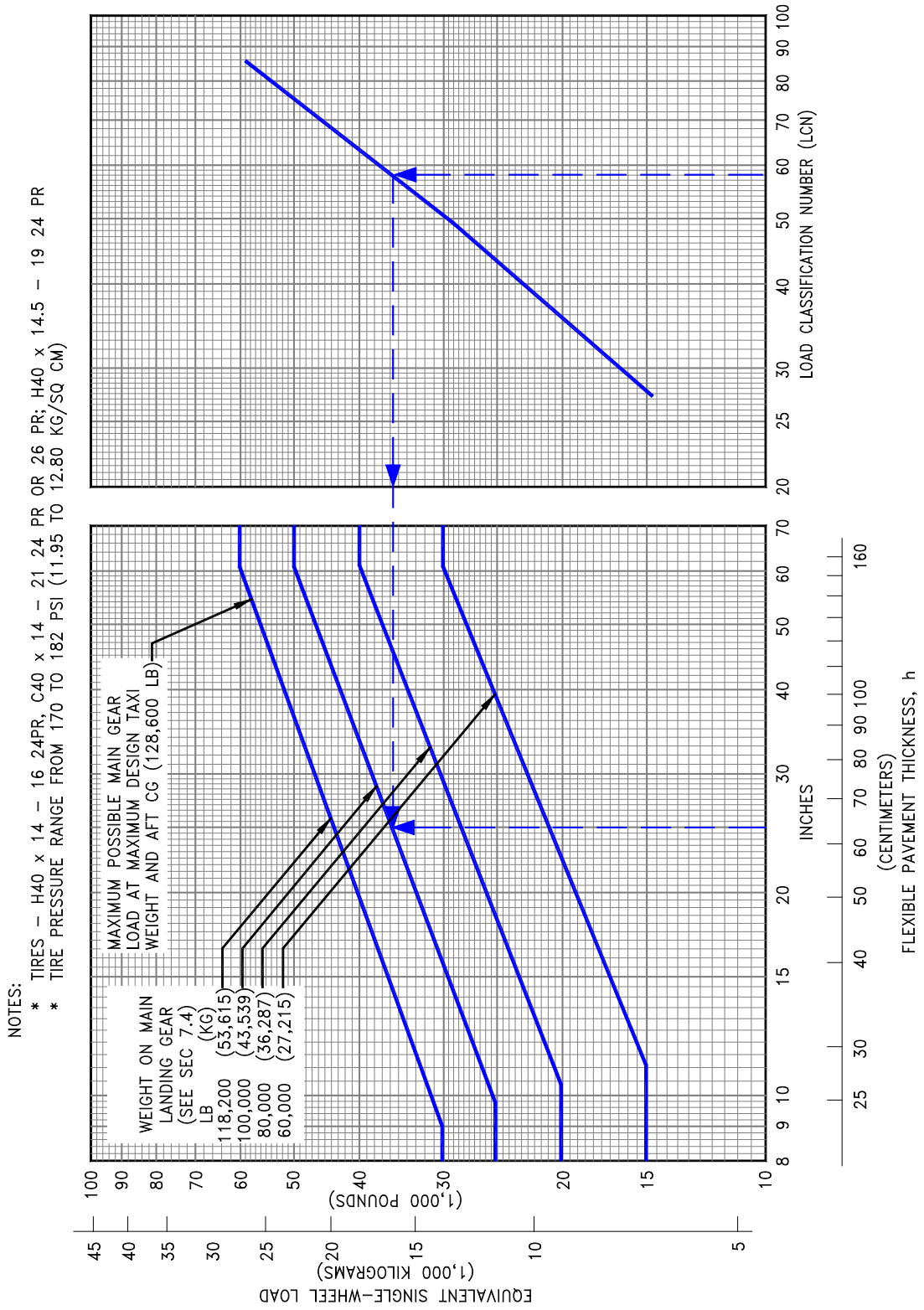

D6-58325-6

7.6.5 Flexible Pavement Requirements - LCN Method: Model 737-300, -400, -500

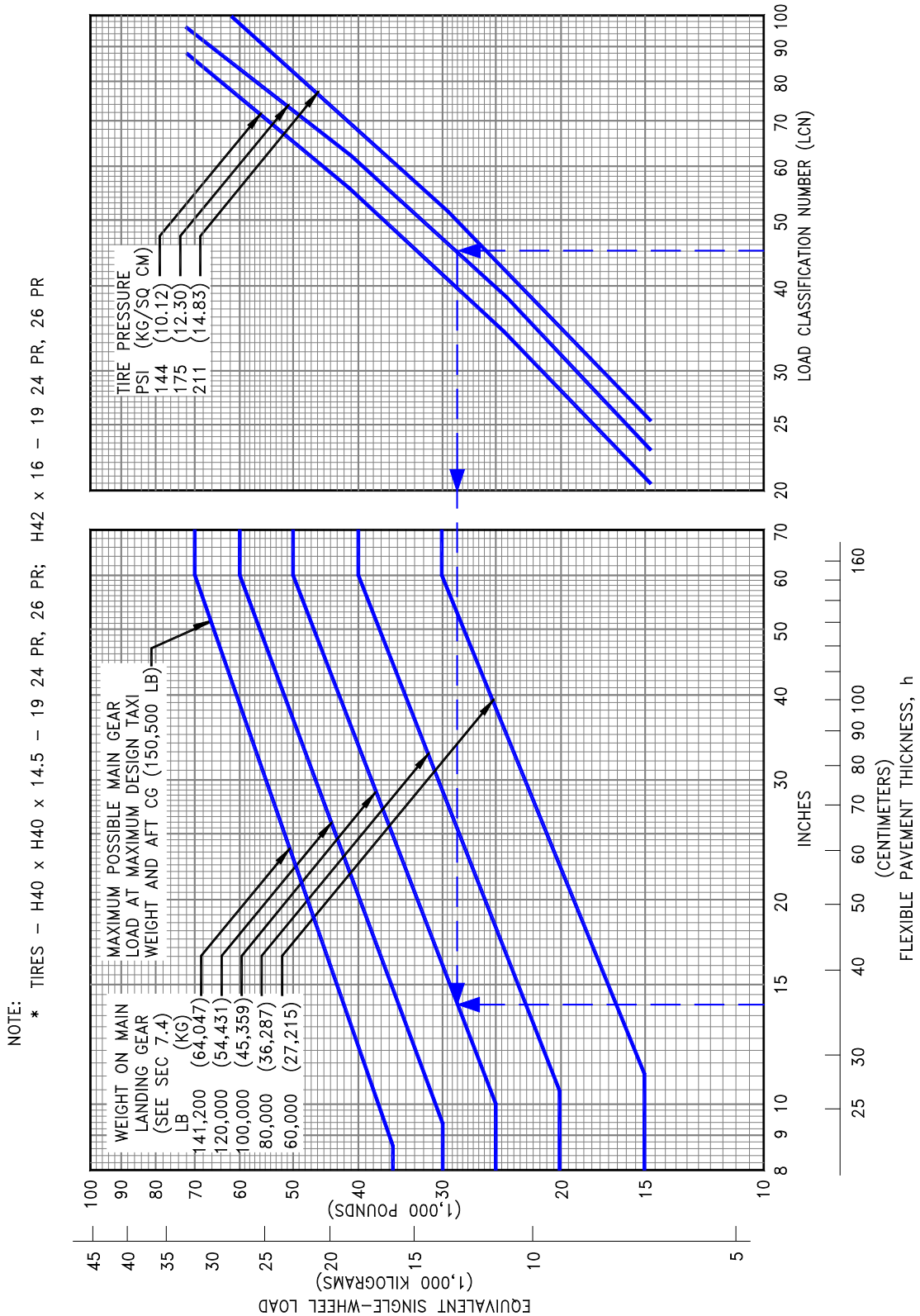

D6-58325-6

7.7 RIGID PAVEMENT REQUIREMENTS - PORTLAND CEMENT ASSOCIATION DESIGN METHOD

The Portland Cement Association method of calculating rigid pavement requirements is based on the computerized version of "Design of Concrete Airport Pavement" (Portland Cement Association, 1965) as described in XP6705-2, "Computer Program for Airport Pavement Design" by Robert G. Packard, Portland Cement Association, 1968.

The following rigid pavement design chart presents the data for five incremental main gear loads at the minimum tire pressure required at the maximum design taxi weight.

In the example shown on the next page, for an allowable working stress of 400 psi, a main gear load of 70,000 lb, and a subgrade strength (k) of 300, the required rigid pavement thickness is 7.7 in. Similar examples are shown in succeeding charts.

7.7.1 Rigid Pavement Requirements - Portland Cement Association Design Method: Model 737-100, 200 to 104,000 LB (47,170KG) MTW

NOTES:

- * TIRES - H40 x 14 - 16 22 PR; C40 x 14 - 21 22PR
- * PRESSURE RANGE FROM 138 TO 146 PSI (9.70 TO 10.27 KG/SQ CM)

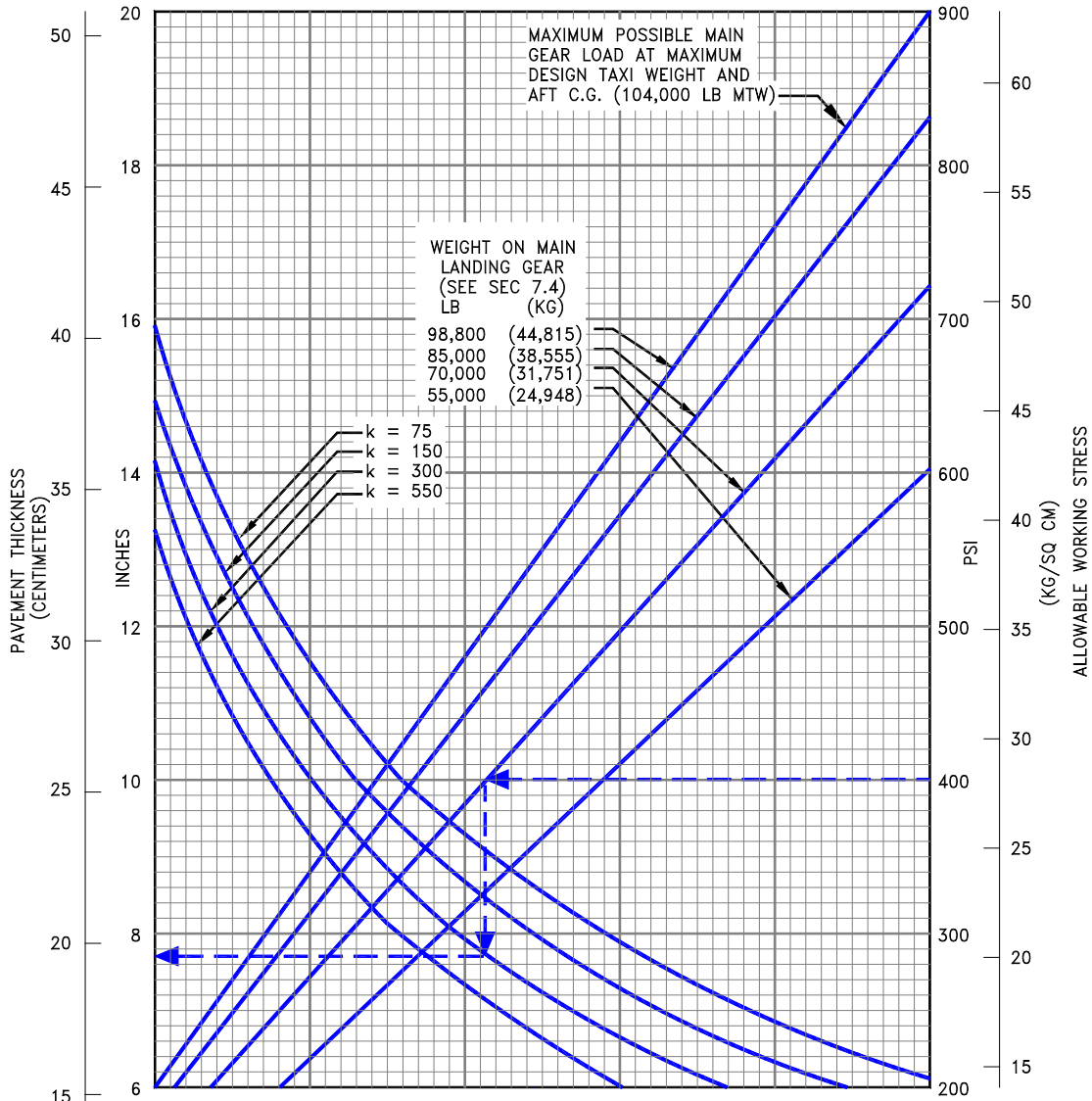

NOTE:
 THE VALUES OBTAINED BY USING THE MAXIMUM LOAD REFERENCE LINE AND ANY VALUE OF k ARE EXACT. FOR LOADS LESS THAN MAXIMUM, THE CURVES ARE EXACT FOR k = 300 BUT DEVIATE SLIGHTLY FOR OTHER VALUES OF k.

REFERENCES:
 "DESIGN OF CONCRETE AIRPORT PAVEMENT" AND "COMPUTER PROGRAM FOR AIRPORT PAVEMENT DESIGN - PROGRAM PDILB" PORTLAND CEMENT ASSOCIATION.

7.7.2 Rigid Pavement Requirements - Portland Cement Association Design Method: Model 737-100, -200, -200ADV at 110,000 to 117,500 LB (49,900 to 53,290 KG) MTW

NOTES:

- * TIRES - H40 x 14 - 16 24 PR; C40 x 14 - 21 24PR
- * PRESSURE RANGE FROM 156 TO 168 PSI (10.97 TO 18.81 KG/SQ CM)

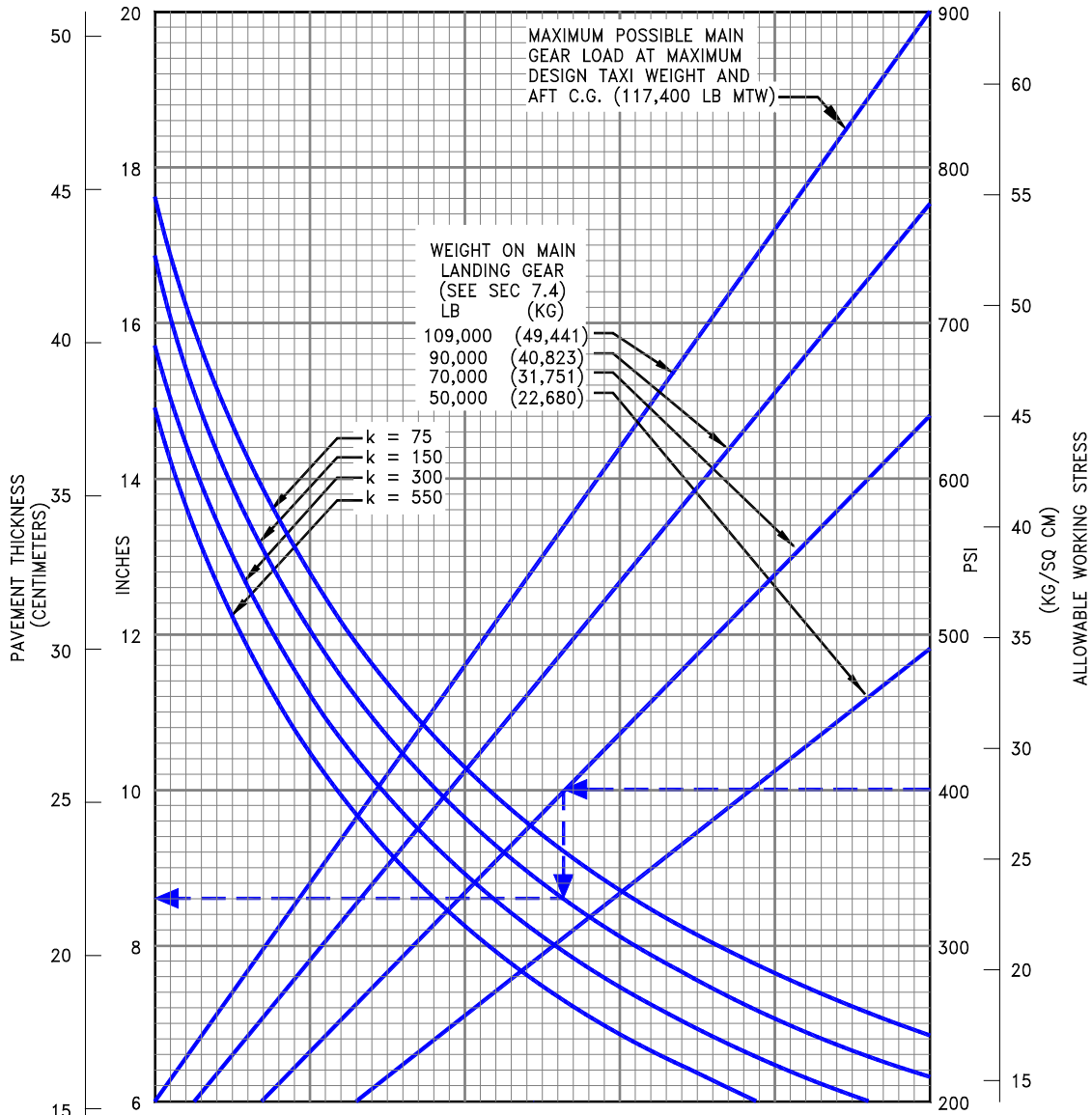

NOTE:
THE VALUES OBTAINED BY USING THE MAXIMUM LOAD REFERENCE LINE AND ANY VALUE OF k ARE EXACT. FOR LOADS LESS THAN MAXIMUM, THE CURVES ARE EXACT FOR $k = 300$ BUT DEVIATE SLIGHTLY FOR OTHER VALUES OF k .

REFERENCES:
"DESIGN OF CONCRETE AIRPORT PAVEMENT" AND "COMPUTER PROGRAM FOR AIRPORT PAVEMENT DESIGN - PROGRAM PDILB"
PORTLAND CEMENT ASSOCIATION.

D6-58325-6

REV D

March 2023

7-29

7.7.3 Rigid Pavement Requirements - Portland Cement Association Design Method: Model 737-200ADV at 116,000 to 117,500 LB (52,610 to 53,290 KG) MTW (LOW PRESSURE TIRES)

NOTES:

- * TIRES - C40 x 18 - 17 20 PR
- * PRESSURE AT 95 OR 96 PSI (6.68 OR 6.75 KG/SQ CM)

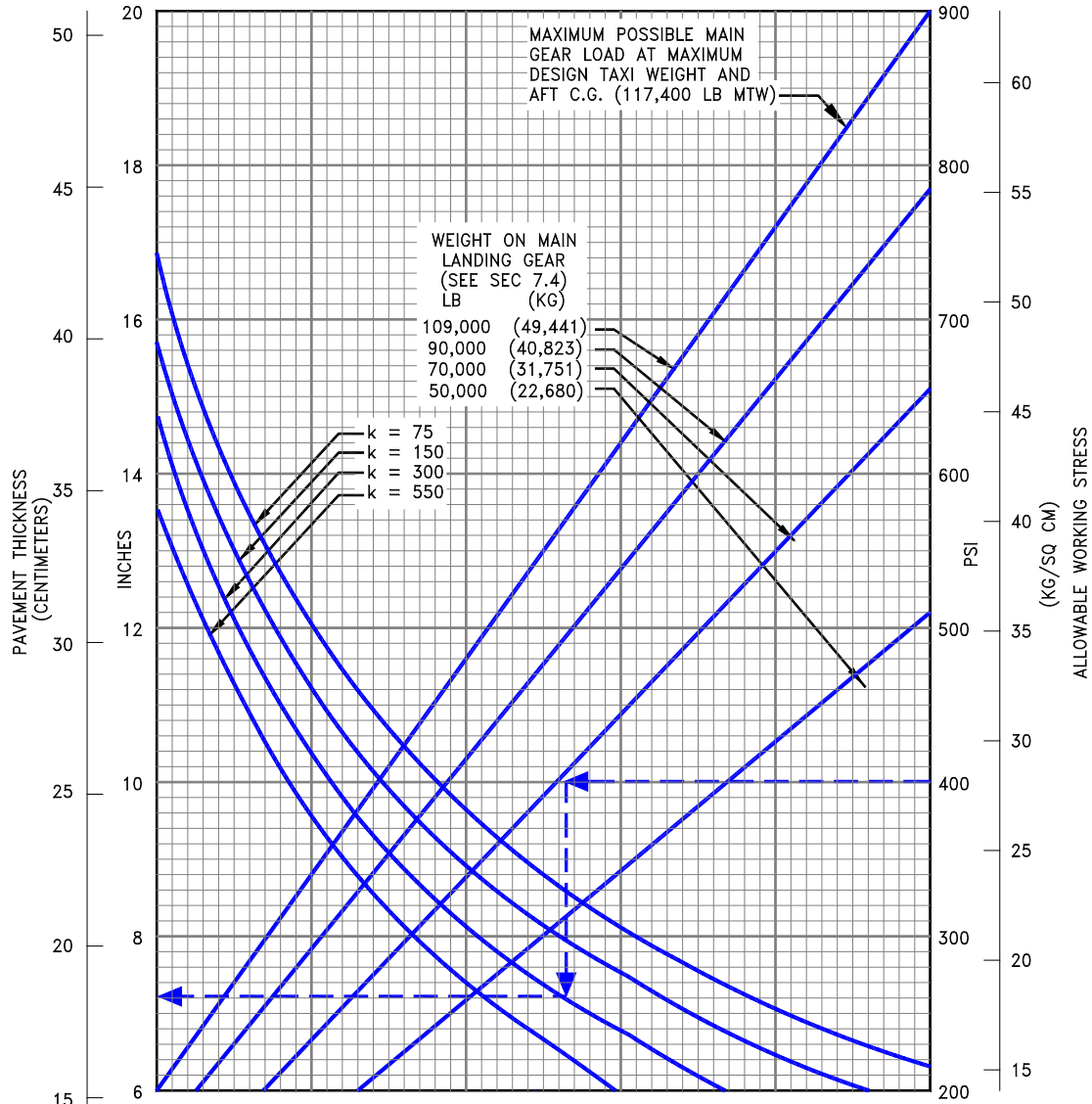

NOTE:
THE VALUES OBTAINED BY USING THE MAXIMUM LOAD REFERENCE LINE AND ANY VALUE OF k ARE EXACT. FOR LOADS LESS THAN MAXIMUM, THE CURVES ARE EXACT FOR k = 300 BUT DEVIATE SLIGHTLY FOR OTHER VALUES OF k.

REFERENCES:
"DESIGN OF CONCRETE AIRPORT PAVEMENT" AND "COMPUTER PROGRAM FOR AIRPORT PAVEMENT DESIGN - PROGRAM PDILB" PORTLAND CEMENT ASSOCIATION.

7.7.4 Rigid Pavement Requirements - Portland Cement Association Design Method: Model 737-200ADV at 120,000 to 128,000 LB (54,430 to 58,330 KG) MTW

NOTES:

- * TIRES - H40 x 14-16 24PR; C40 x 14- 1 24PR OR 26PR; H40 x 14.5-19 24PR
- * PRESSURE RANGE FROM 170 TO 182 PSI (11.95 TO 12.80 KG/SQ CM)

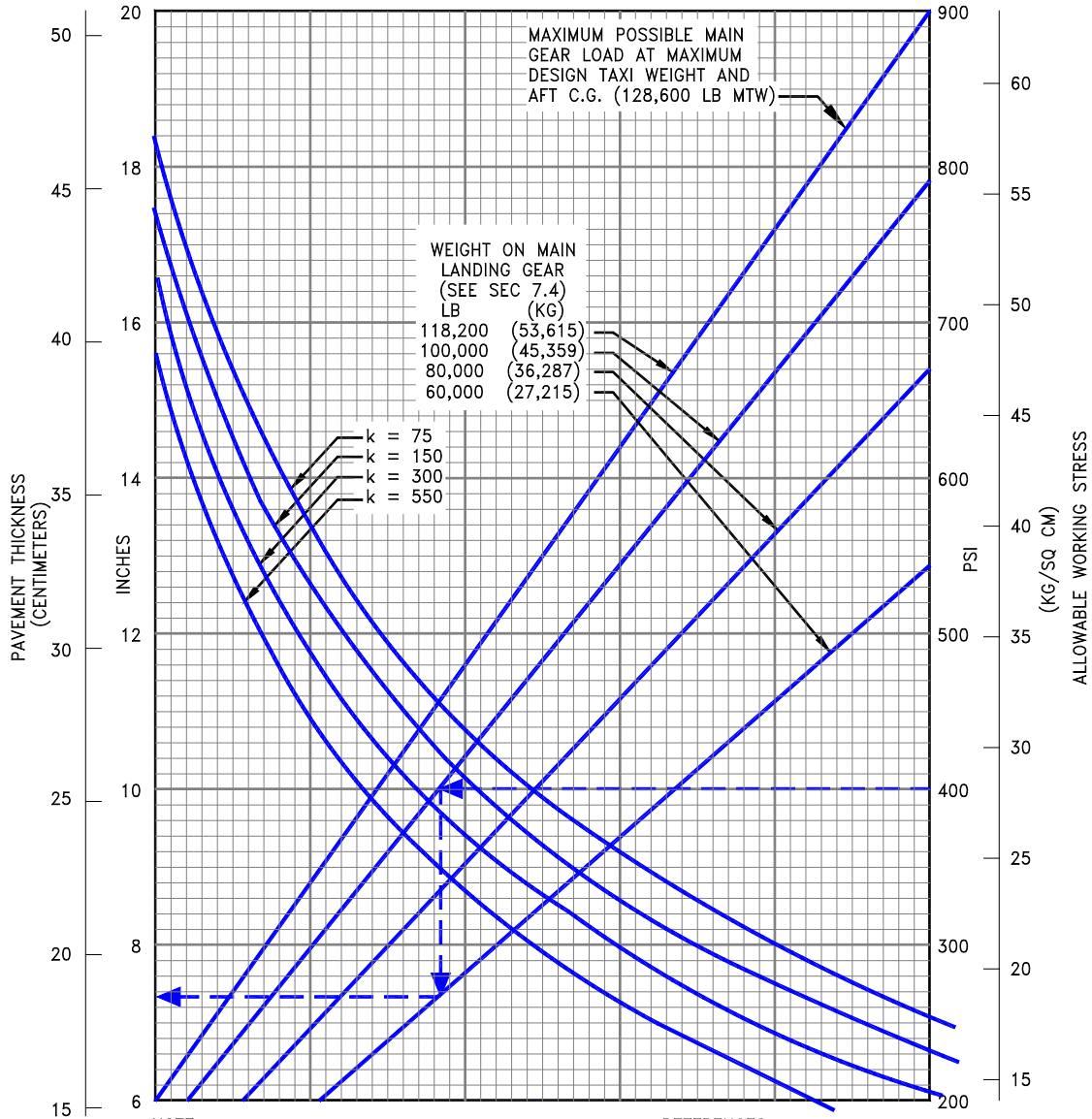

NOTE:
 THE VALUES OBTAINED BY USING THE MAXIMUM LOAD REFERENCE LINE AND ANY VALUE OF k ARE EXACT. FOR LOADS LESS THAN MAXIMUM, THE CURVES ARE EXACT FOR k = 300 BUT DEVIATE SLIGHTLY FOR OTHER VALUES OF k.

REFERENCES:
 "DESIGN OF CONCRETE AIRPORT PAVEMENT" AND "COMPUTER PROGRAM FOR AIRPORT PAVEMENT DESIGN - PROGRAM PDILB"
 PORTLAND CEMENT ASSOCIATION.

7.7.5 Rigid Pavement Requirements - Portland Cement Association Design Method: Model 737-300, -400, -500

NOTES:

* TIRES - H40 x 14.5-19 24PR, 26PR; H42 x 16-19 26PR

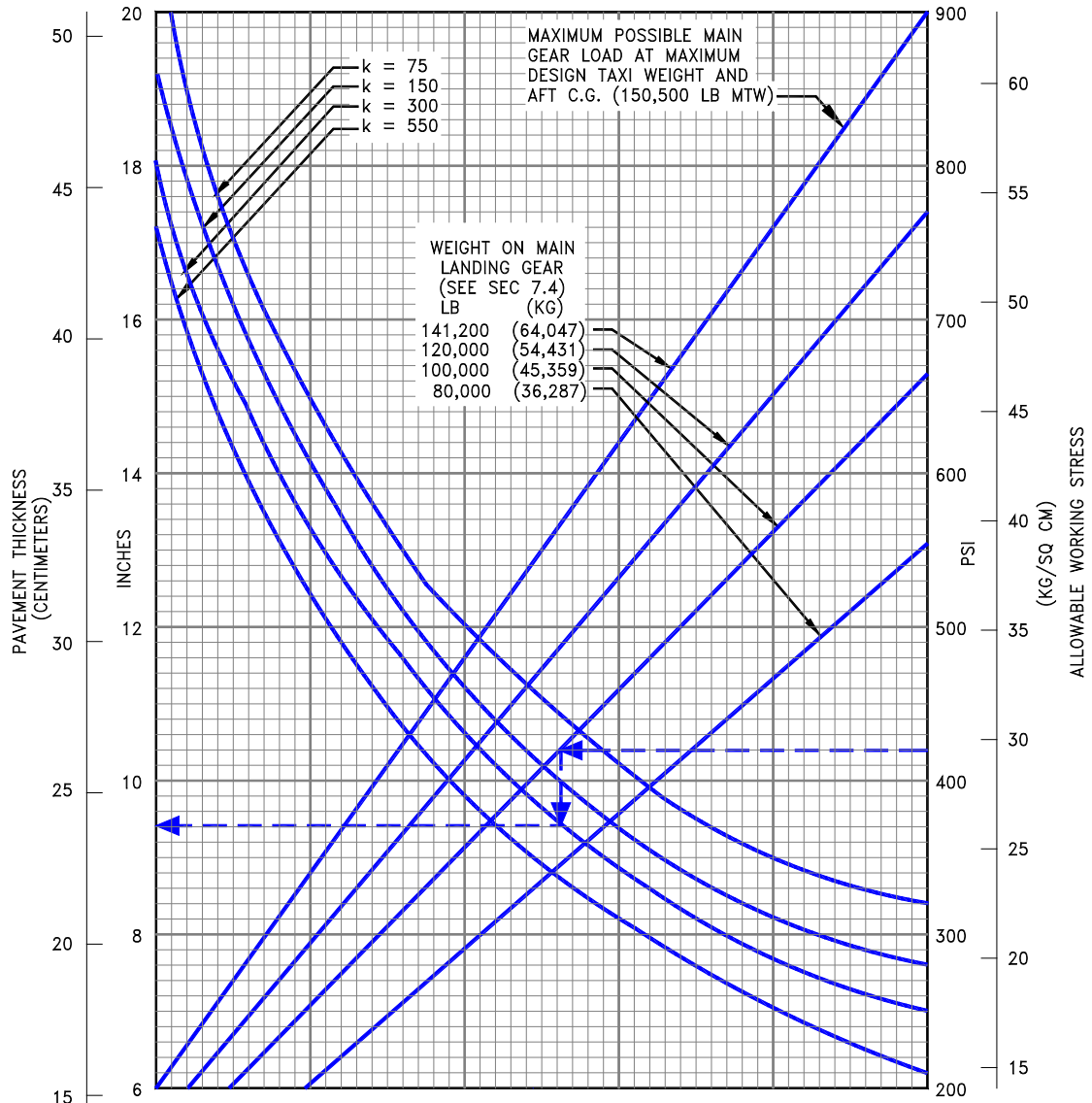

NOTE:
THE VALUES OBTAINED BY USING THE MAXIMUM LOAD REFERENCE LINE AND ANY VALUE OF k ARE EXACT. FOR LOADS LESS THAN MAXIMUM, THE CURVES ARE EXACT FOR $k = 300$ BUT DEVIATE SLIGHTLY FOR OTHER VALUES OF k .

REFERENCES:
"DESIGN OF CONCRETE AIRPORT PAVEMENT" AND "COMPUTER PROGRAM FOR AIRPORT PAVEMENT DESIGN - PROGRAM PDILB"
PORTLAND CEMENT ASSOCIATION.

D6-58325-6

REV D

March 2023

7-32

7.7.6 Rigid Pavement Requirements - Portland Cement Association Design Method: Model 737-300, -400, -500 (Low Pressure Tires)

NOTES:

* TIRES - H42 x 16-19 26PR

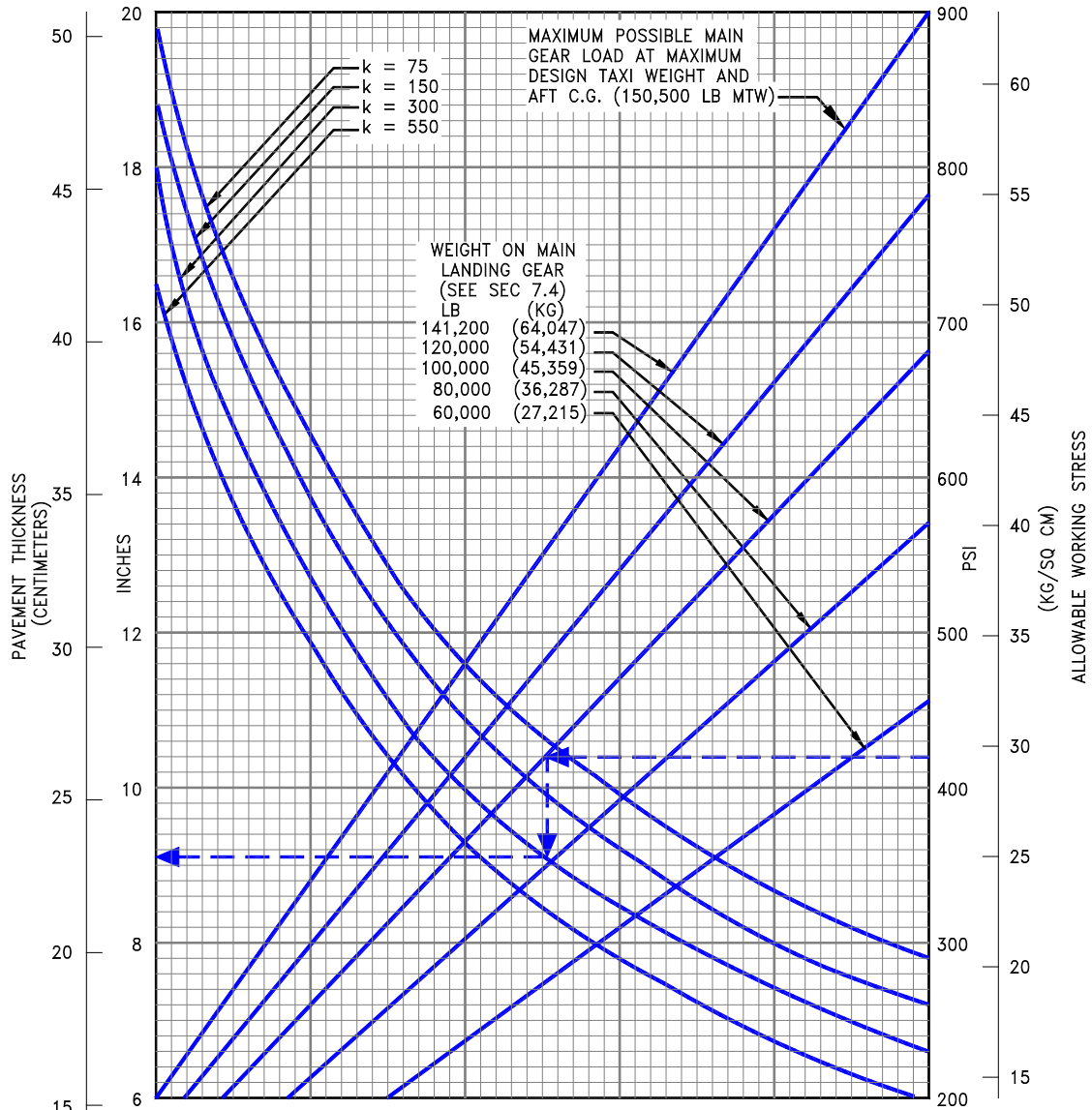

NOTE:
THE VALUES OBTAINED BY USING THE MAXIMUM LOAD REFERENCE LINE AND ANY VALUE OF k ARE EXACT. FOR LOADS LESS THAN MAXIMUM, THE CURVES ARE EXACT FOR $k = 300$ BUT DEVIATE SLIGHTLY FOR OTHER VALUES OF k .

REFERENCES:
"DESIGN OF CONCRETE AIRPORT PAVEMENT" AND "COMPUTER PROGRAM FOR AIRPORT PAVEMENT DESIGN - PROGRAM PDILB"
PORTLAND CEMENT ASSOCIATION.

D6-58325-6

REV D

March 2023

7-33

7.8 RIGID PAVEMENT REQUIREMENTS - LCN CONVERSION

To determine the airplane weight that can be accommodated on a particular rigid pavement, both the LCN of the pavement and the radius of relative stiffness (k) of the pavement must be known.

In the examples shown in Section 7.8.2 for a rigid pavement with a radius of relative stiffness of 47 with an LCN of 91, and 7.8.3 for a rigid pavement with a radius of relative stiffness of 47 with an LCN of 87, the apparent maximum allowable weight permissible on the main landing gear is 600,000 lb (272,155 kg) for an airplane with 221-psi (15.54 kg/cm²) main tires.

Note: If the resultant aircraft LCN is not more than 10% above the published pavement LCN, the bearing strength of the pavement can be considered sufficient for unlimited use by the airplane. The figure 10% has been chosen as representing the lowest degree of variation in LCN that is significant (reference: ICAO Aerodrome Design Manual, Part 2, "Aerodrome Physical Characteristics," Chapter 4, Paragraph 4.1.5.7v, 2nd Edition dated 1965).

7.8.1 Radius of Relative Stiffness (Reference: Portland Cement Association)

RADIUS OF RELATIVE STIFFNESS (l)
VALUES IN INCHES

$$l = \sqrt[4]{\frac{Ed^3}{12(1-\mu^2)k}} = 24.1652 \sqrt[4]{\frac{d^3}{k}}$$

WHERE: E = YOUNG'S MODULUS OF ELASTICITY = 4×10^6 psi

k = SUBGRADE MODULUS, LB PER CU IN

d = RIGID PAVEMENT THICKNESS, IN

μ = POISSON'S RATIO = 0.15

d	k = 75	k = 100	k = 150	k = 200	k = 250	k = 300	k = 350	k = 400	k = 500	k = 550
6.0	31.48	29.29	26.47	24.63	23.30	22.26	21.42	20.71	19.59	19.13
6.5	33.42	31.10	28.11	26.16	24.74	23.63	22.74	21.99	20.80	20.31
7.0	35.33	32.88	29.71	27.65	26.15	24.99	24.04	23.25	21.99	21.47
7.5	37.21	34.63	31.29	29.12	27.54	26.31	25.32	24.49	23.16	22.61
8.0	39.06	36.35	32.84	30.56	28.91	27.62	26.57	25.70	24.31	23.73
8.5	40.87	38.04	34.37	31.99	30.25	28.90	27.81	26.90	25.44	24.84
9.0	42.66	39.70	35.88	33.39	31.57	30.17	29.03	28.07	26.55	25.93
9.5	44.43	41.35	37.36	34.77	32.88	31.42	30.23	29.24	27.65	27.00
10.0	46.17	42.97	38.83	36.13	34.17	32.65	31.41	30.38	28.73	28.06
10.5	47.89	44.57	40.27	37.48	35.44	33.87	32.58	31.52	29.81	29.10
11.0	49.59	46.15	41.70	38.81	36.70	35.07	33.74	32.63	30.86	30.14
11.5	51.27	47.72	43.12	40.12	37.95	36.26	34.89	33.74	31.91	31.16
12.0	52.94	49.26	44.51	41.43	39.18	37.43	36.02	34.83	32.94	32.17
12.5	54.58	50.80	45.90	42.71	40.40	38.60	37.14	35.92	33.97	33.17
13.0	56.21	52.31	47.27	43.99	41.60	39.75	38.25	36.99	34.98	34.16
13.5	57.83	53.81	48.63	45.25	42.80	40.89	39.34	38.05	35.99	35.14
14.0	59.43	55.30	49.97	46.50	43.98	42.02	40.43	39.10	36.98	36.11
14.5	61.01	56.78	51.30	47.74	45.15	43.14	41.51	40.15	37.97	37.07
15.0	62.58	58.24	52.62	48.97	46.32	44.25	42.58	41.18	38.95	38.03
15.5	64.14	59.69	53.93	50.19	47.47	45.35	43.64	42.21	39.92	38.98
16.0	65.69	61.13	55.23	51.40	48.61	46.45	44.69	43.22	40.88	39.92
16.5	67.22	62.55	56.52	52.60	49.75	47.53	45.73	44.23	41.83	40.85
17.0	68.74	63.97	57.80	53.79	50.87	48.61	46.77	45.23	42.78	41.77
17.5	70.25	65.38	59.07	54.97	51.99	49.68	47.80	46.23	43.72	42.69
18.0	71.75	66.77	60.34	56.15	53.10	50.74	48.82	47.22	44.65	43.60
19.0	74.72	69.54	62.83	58.47	55.30	52.84	50.84	49.17	46.50	45.41
20.0	77.65	72.26	65.30	60.77	57.47	54.91	52.83	51.10	48.33	47.19
21.0	80.55	74.96	67.73	63.03	59.61	56.95	54.80	53.00	50.13	48.95
22.0	83.41	77.62	70.14	65.27	61.73	58.98	56.75	54.88	51.91	50.68
23.0	86.23	80.25	72.51	67.48	63.82	60.98	58.67	56.74	53.67	52.40
24.0	89.03	82.85	74.86	69.67	65.89	62.95	60.57	58.58	55.41	54.10
25.0	91.80	85.43	77.19	71.84	67.94	64.91	62.46	60.41	57.13	55.78

7.8.2 Rigid Pavement Requirements - LCN Conversion: Model 737-100, -200 to 104,000 LB (47,170 KG) MTW

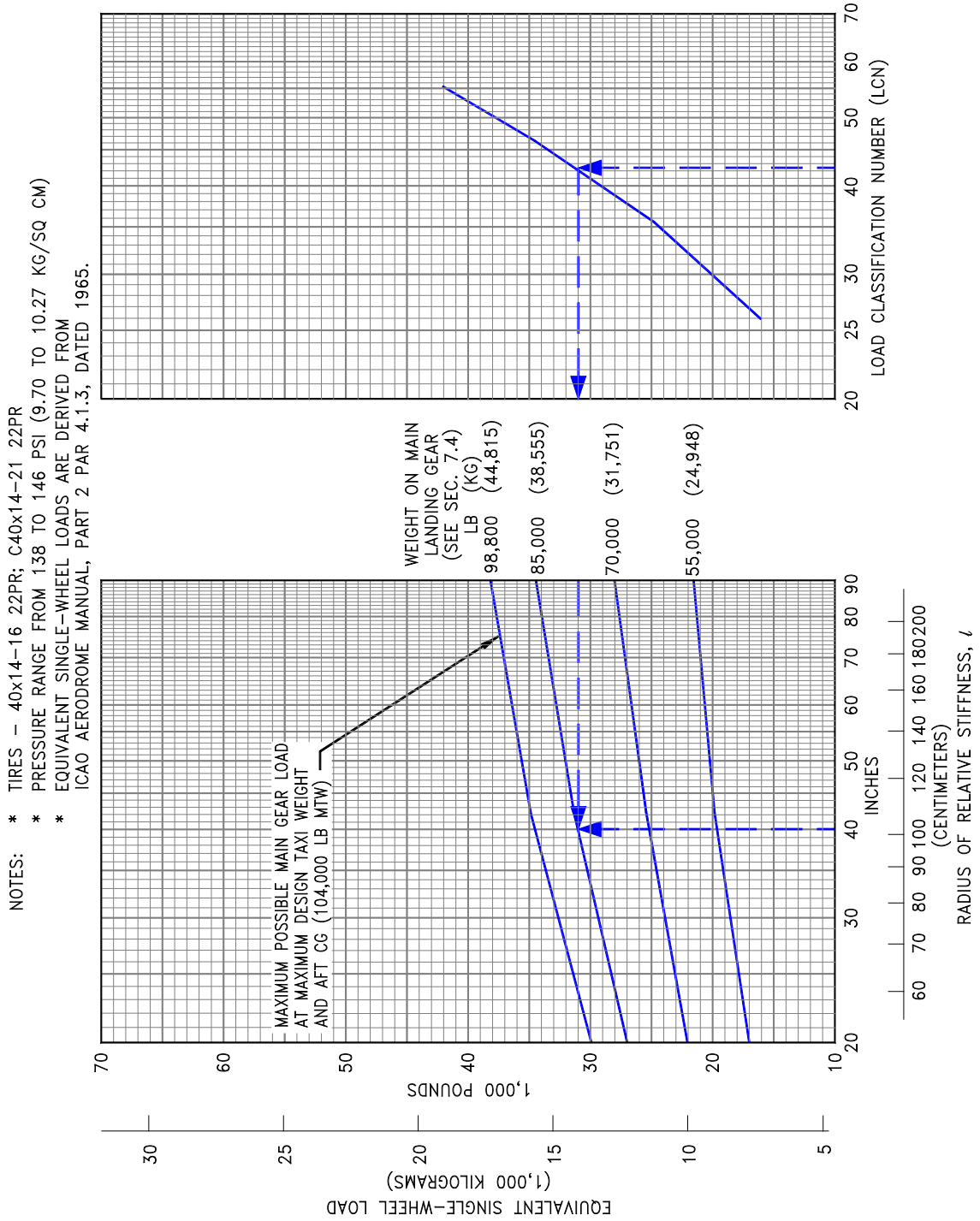

D6-58325-6

7.8.3 Rigid Pavement Requirements - LCN Conversion: Model 737-100, -200 at 110,000 to 117,500 LB (49,900 to 53,290 KG) MTW

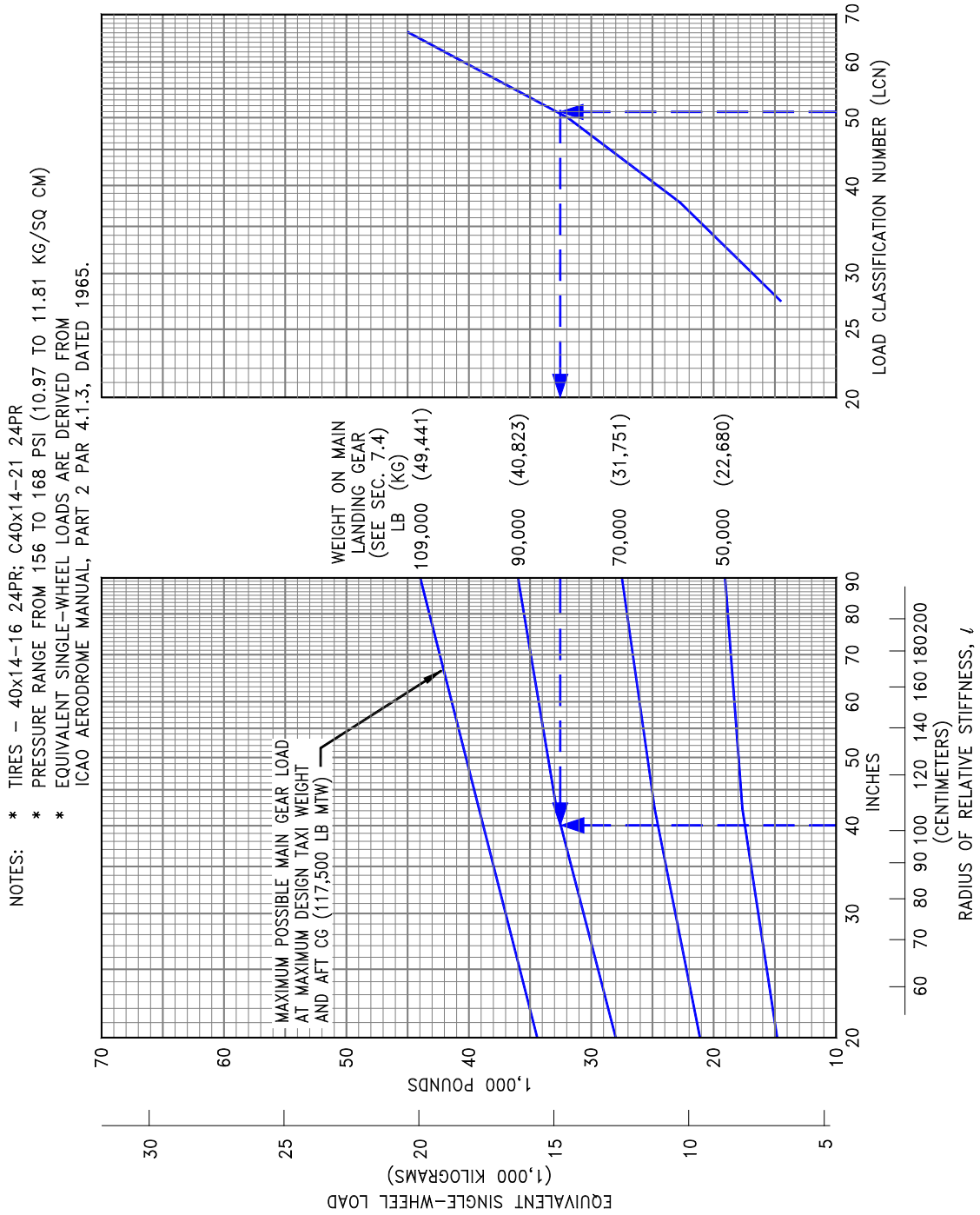

D6-58325-6

REV D

March 2023

7-37

7.8.4 Rigid Pavement Requirements - LCN Conversion: Model 737-200ADV at 116,000 to 117,500 LB (52,610 to 53,290 KG) MTW (Low Pressure Tires)

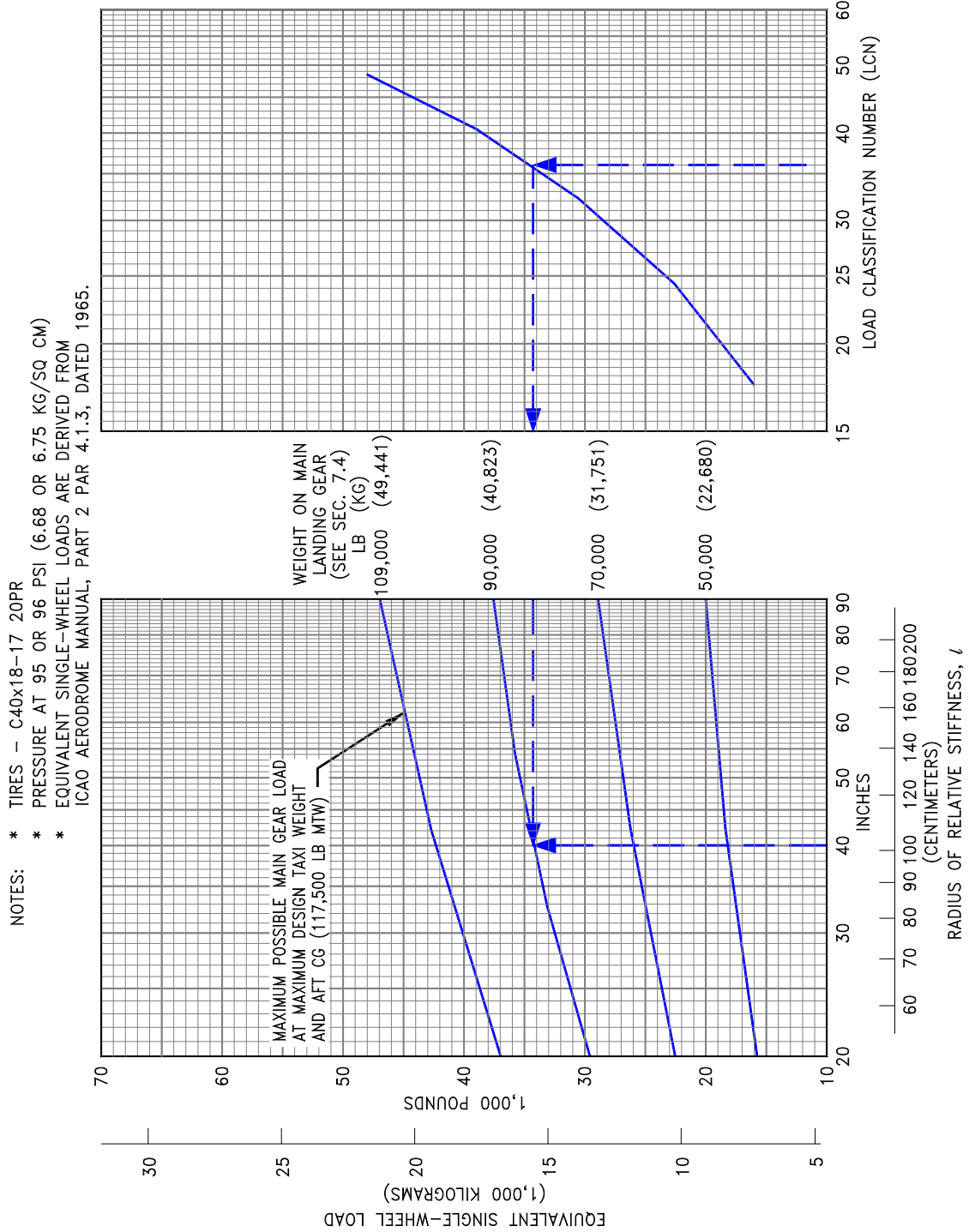

D6-58325-6

7.8.5 Rigid Pavement Requirements - LCN Conversion: Model 737-200ADV at 120,000 to 128,600 LB (54,430 to 58,330 KG) MTW

- NOTES:
- * TIRES - 40x14-16 24PR; C40x14-21 24PR OR 26PR; H40x14.5-19 24PR
 - * PRESSURE RANGE FROM 170 TO 182 PSI (11.95 TO 12.80 KG/SQ CM)
 - * EQUIVALENT SINGLE-WHEEL LOADS ARE DERIVED FROM ICAO AERODROME MANUAL, PART 2 PAR 4.1.3, DATED 1965.

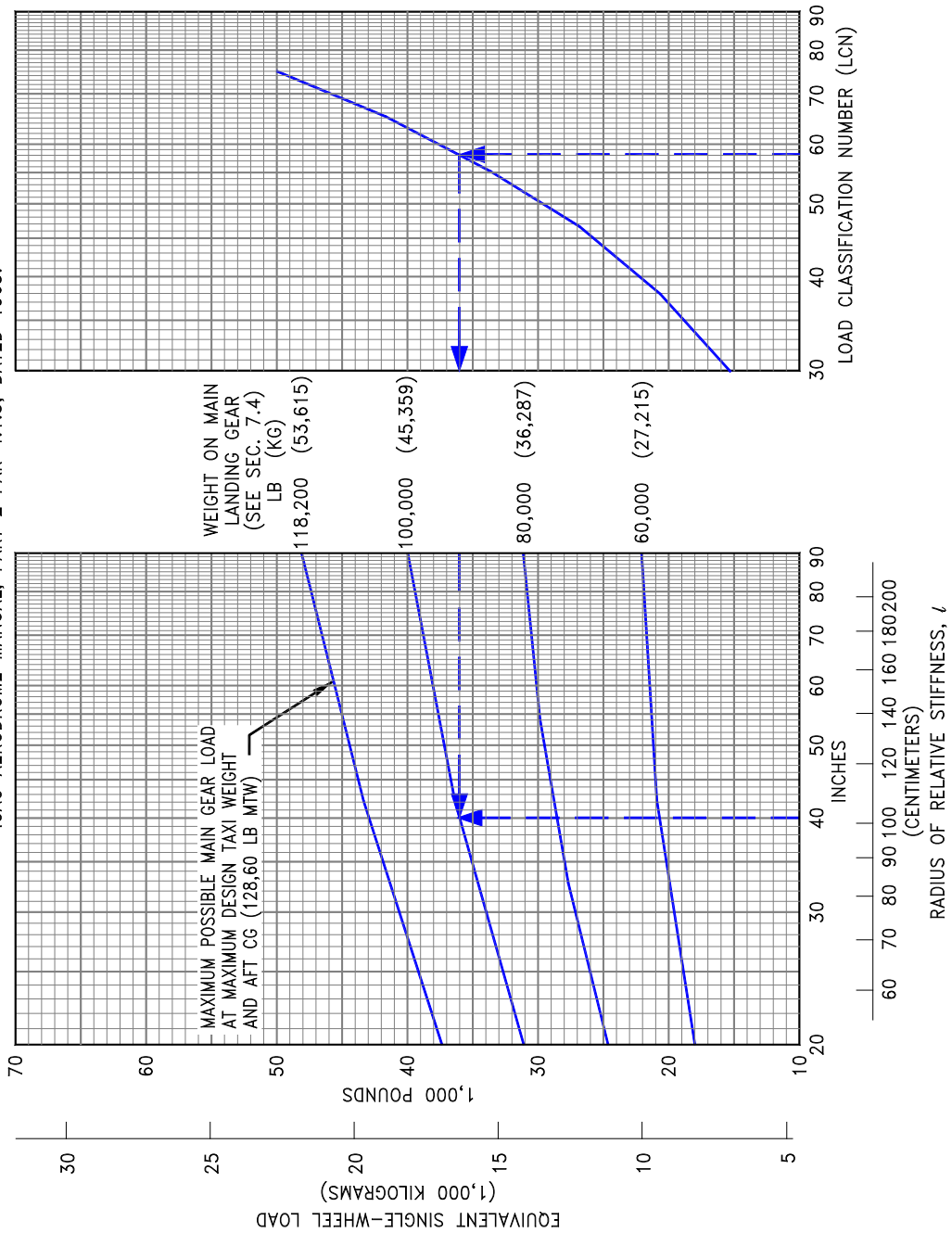

7.8.6 Rigid Pavement Requirements - LCN Conversion: Model 737-300, -400, -500

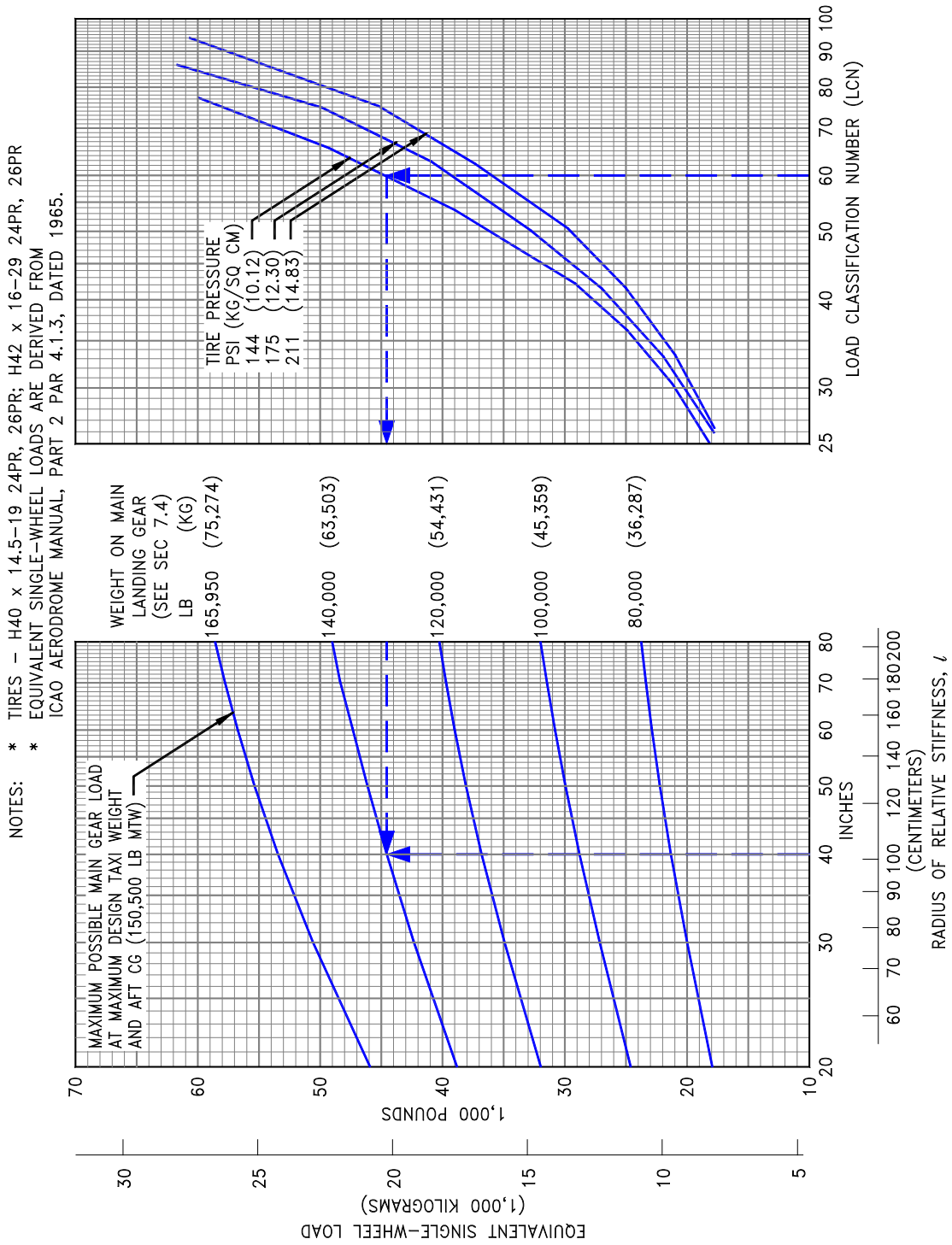

D6-58325-6

REV D

March 2023

7-40

7.9 RIGID PAVEMENT REQUIREMENTS - FAA DESIGN METHOD

The following rigid pavement design charts present data on five incremental main gear loads at the minimum tire pressure required at the maximum design taxi weight.

In the example shown in the next page, the pavement flexural stress is shown at 700 psi, the subgrade strength is shown at $k = 550$, and the annual departure level is 6,000. For these conditions, the required rigid pavement thickness for an airplane with main gear load of 100,000 pounds is 10.4 inches. Similar examples are shown in succeeding charts.

For the rigid pavement design refer to the FAA AC 150/5320-6F “Airport Pavement Design and Evaluation” and pavement design program FAARFIELD. Both are available on the FAA website:

FAA AC 150/5320-6F: https://www.faa.gov/airports/resources/advisory_circulars/
FAARFIELD: https://www.faa.gov/airports/engineering/design_software/

7.9.1 Rigid Pavement Requirements – FAA Design Method: Model 737-100, -200

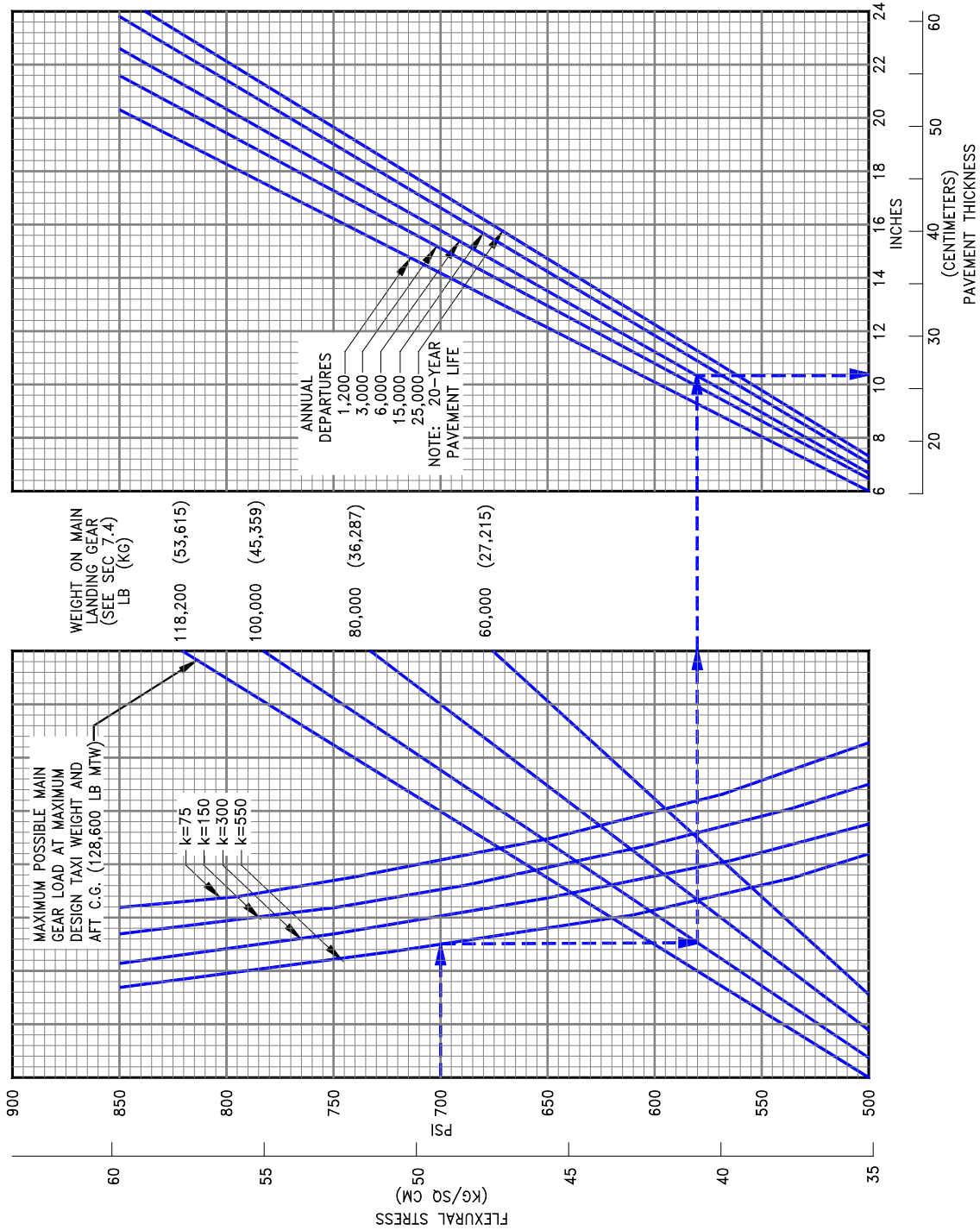

7.9.2 Rigid Pavement Requirements – FAA Design Method: Model 737-200ADV (Low Pressure Tires)

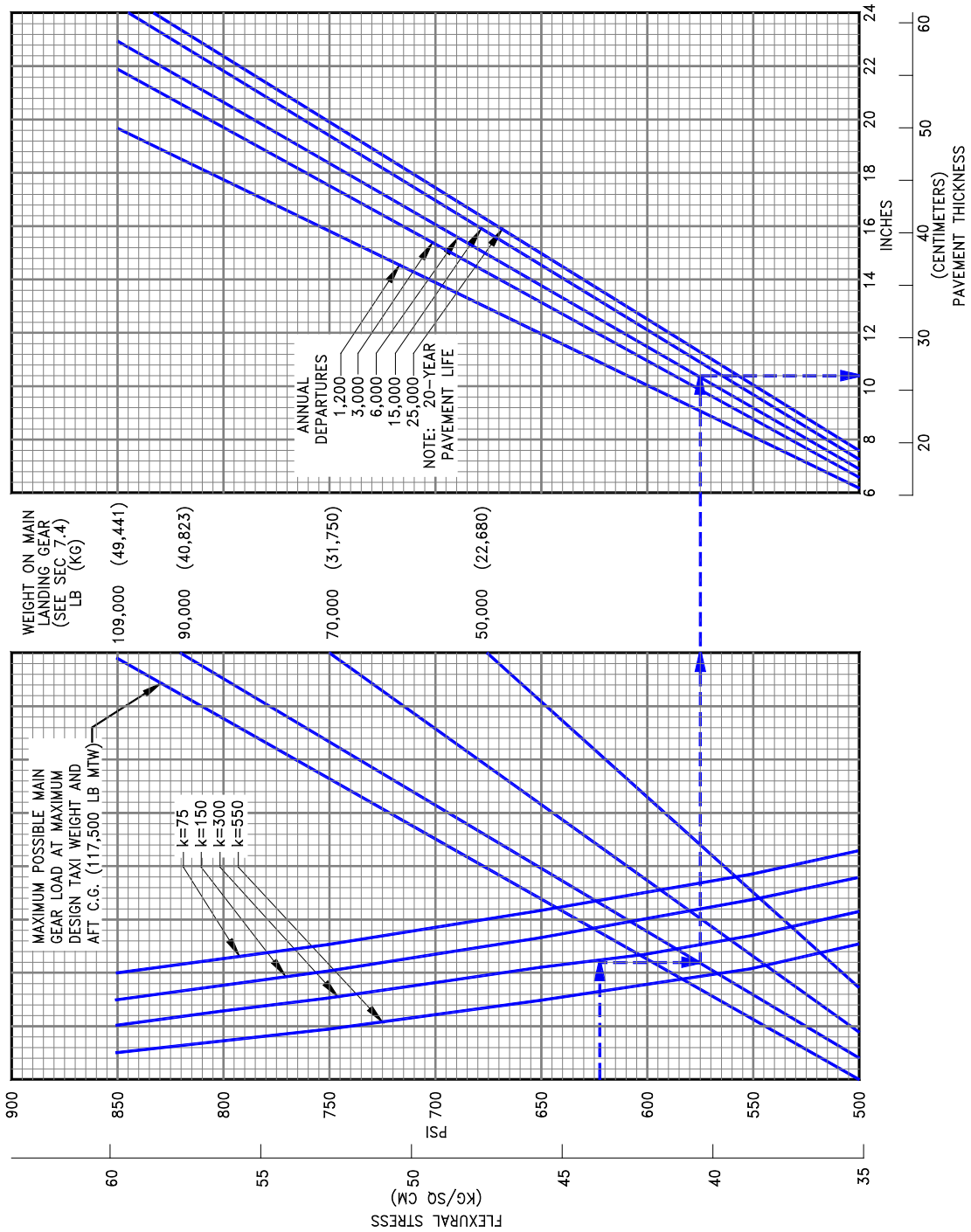

D6-58325-6

7.9.3 Rigid Pavement Requirements – FAA Design Method: Model 737-300, -400, -500

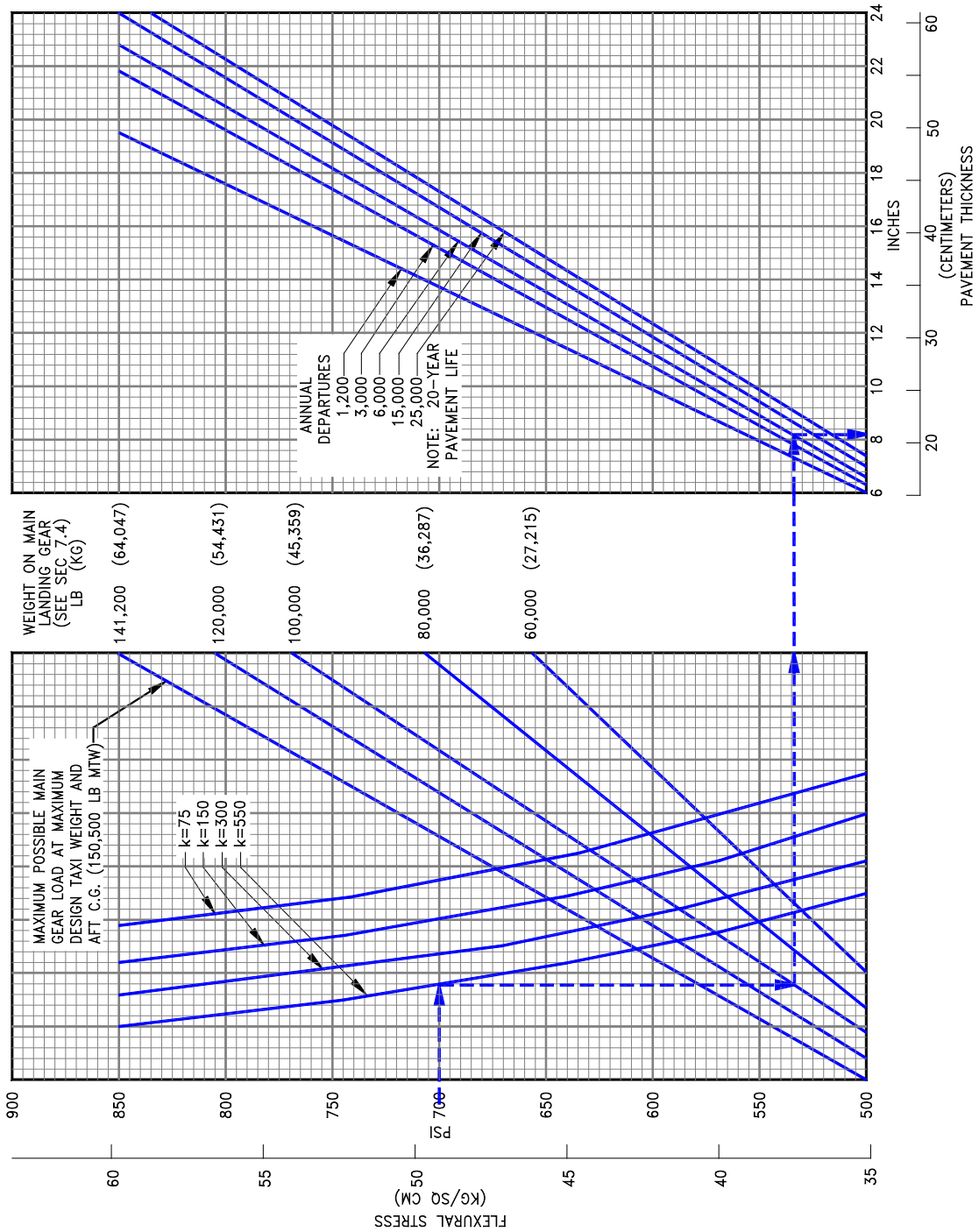

D6-58325-6

7.9.4 Rigid Pavement Requirements – FAA Design Method: Model 737-300, -400, -500 (Low Pressure Tires)

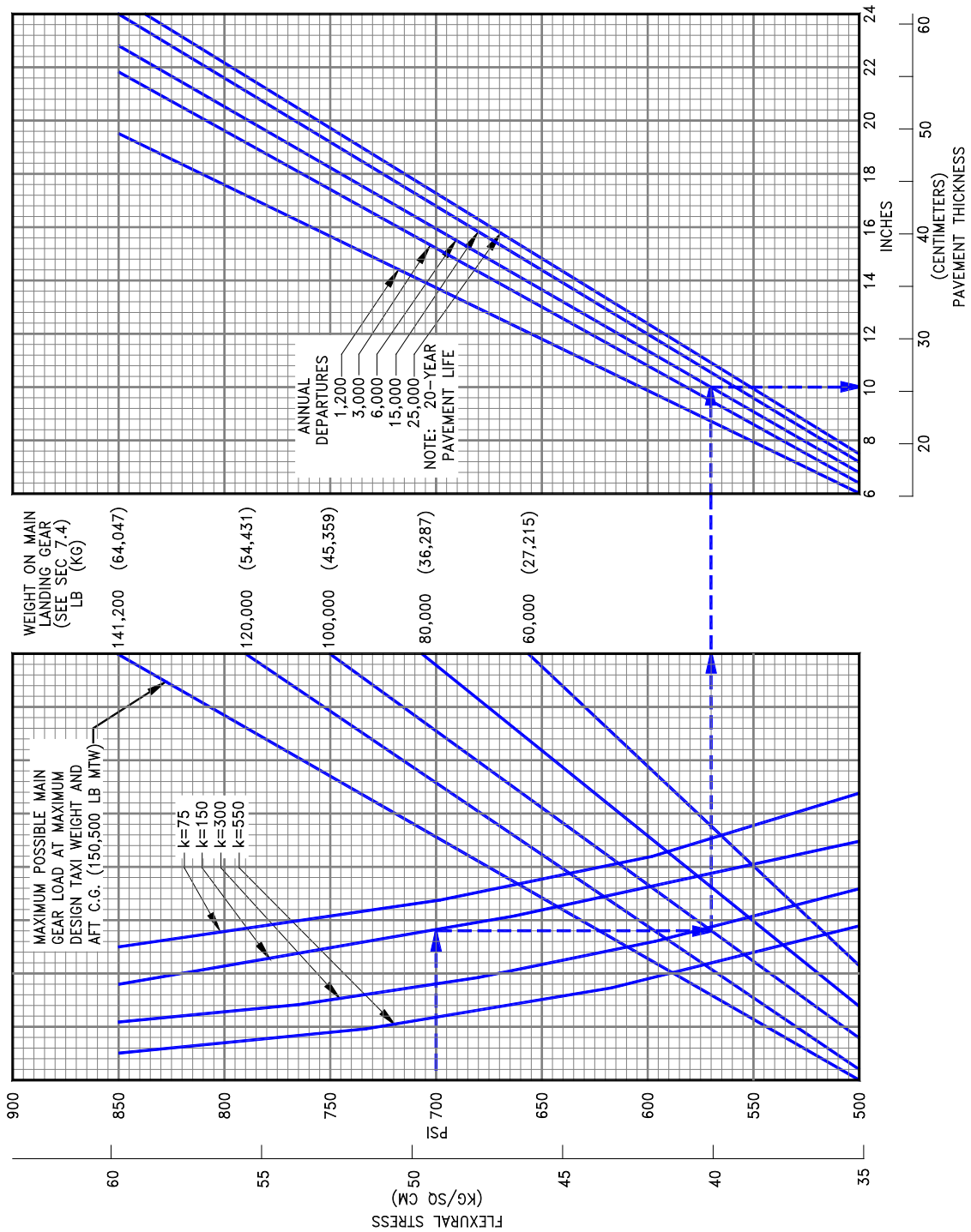

D6-58325-6

7.10 ACN/PCN REPORTING SYSTEM - FLEXIBLE AND RIGID PAVEMENTS

To determine the ACN of an aircraft on flexible or rigid pavement, both the aircraft gross weight and the subgrade strength category must be known. In the chart in Section 7.10.1, for a 737-100 aircraft with gross weight of 80,000 lb and low subgrade strength, the flexible pavement ACN is 19.2. In Section 7.10.11, for the same gross weight and subgrade strength, the rigid pavement ACN is 20.6.

Note: An aircraft with an ACN equal to or less than the reported PCN can operate on that pavement subject to any limitations on the tire pressure.

The following table provides ACN data in tabular format similar to the one used by ICAO in the “Aerodrome Design Manual Part 3, Pavements”. If the ACN for an intermediate weight between maximum taxi weight and the empty weight of the aircraft is required, Sections 7.10.1 through 7.10.20 should be consulted.

AIRCRAFT TYPE	MAXIMUM TAXI WEIGHT MINIMUM WEIGHT (1) LB (KG)	LOAD ON ONE MAIN GEAR LEG (%)	TIRE PRESSURE PSI (MPa)	ACN FOR RIGID PAVEMENT SUBGRADES – MN/m ³				ACN FOR FLEXIBLE PAVEMENT SUBGRADES – CBR			
				HIGH 150	MEDIUM 80	LOW 40	ULTRA LOW 20	HIGH 15	MEDIUM 10	LOW 6	ULTRA LOW 3
737-100	111,000 (50,349) 62,000 (28,123)	45.95	157 (1.08)	27 14	29 15	31 16	32 17	25 13	26 13	29 14	33 16
737-200	128,600 (58,332) 65,300 (29,620)	45.96	182 (1.25)	34 15	36 16	38 17	39 18	30 14	31 14	35 15	39 17
737-300	140,000 (63,503) 72,540 (32,904)	45.43	201 (1.38)	38 17	40 18	42 19	43 20	33 15	35 16	39 17	43 20
737-400	150,500 (68,266) 74,170 (33,643)	46.91	185 (1.27)	42 18	44 19	47 20	48 21	37 16	39 17	44 18	48 21
737-500	134,000 (60,781) 69,030 (31,311)	46.12	194 (1.33)	37 17	38 18	40 19	42 20	32 15	33 15	37 16	41 19
737-600	145,000 (65,771) 80,200 (36,378)	45.83	182 (1.25)	37 19	39 19	41 21	43 22	33 17	34 17	38 19	44 21
737-600	144,000 (65,317) 80,200 (36,378)	45.83	168 (1.15)	36 18	38 19	40 20	42 22	33 17	34 17	38 18	43 21
737-700	155,000 (70,307) 83,000 (37,648)	45.85	197 (1.36)	41 19	43 20	46 22	47 23	36 18	38 18	42 19	47 22
737-700	155,000 (70,307) 83,000 (37,648)	45.85	179 (1.23)	40 20	42 21	45 22	47 23	36 18	37 18	42 19	47 22
737 BBJ	171,500 (77,790) 100,000 (45,360)	45.86	204 (1.41)	47 25	49 26	52 28	54 29	41 22	43 23	48 24	53 28
737-800	174,700 (79,242) 91,300 (41,413)	46.79	204 (1.41)	49 23	52 24	54 25	56 27	43 20	45 21	50 22	55 26
737 BBJ2	174,700(79,260) 100,000(45,360)	46.79	204 (1.41)	49 24	52 26	54 28	56 30	42 22	45 23	50 25	55 29
737-900	174,700 (79,242) 94,580 (42,901)	46.79	204 (1.41)	49 24	52 25	54 27	56 28	43 21	45 22	50 23	55 27
737-900ER	188,200(85,366) 98,495(44,676)	47.29	220 (1.52)	56 26	58 27	61 29	63 30	48 22	51 23	56 25	61 29

NOTE: VALUES FOR 737-700, -800, -900, -900ER ARE VALID FOR MODELS WITH AND WITHOUT WINGLETS.

7.10.1 Aircraft Classification Number - Flexible Pavement: Model 737-100, -200 to 104,000 LB (47,170 KG) MTW

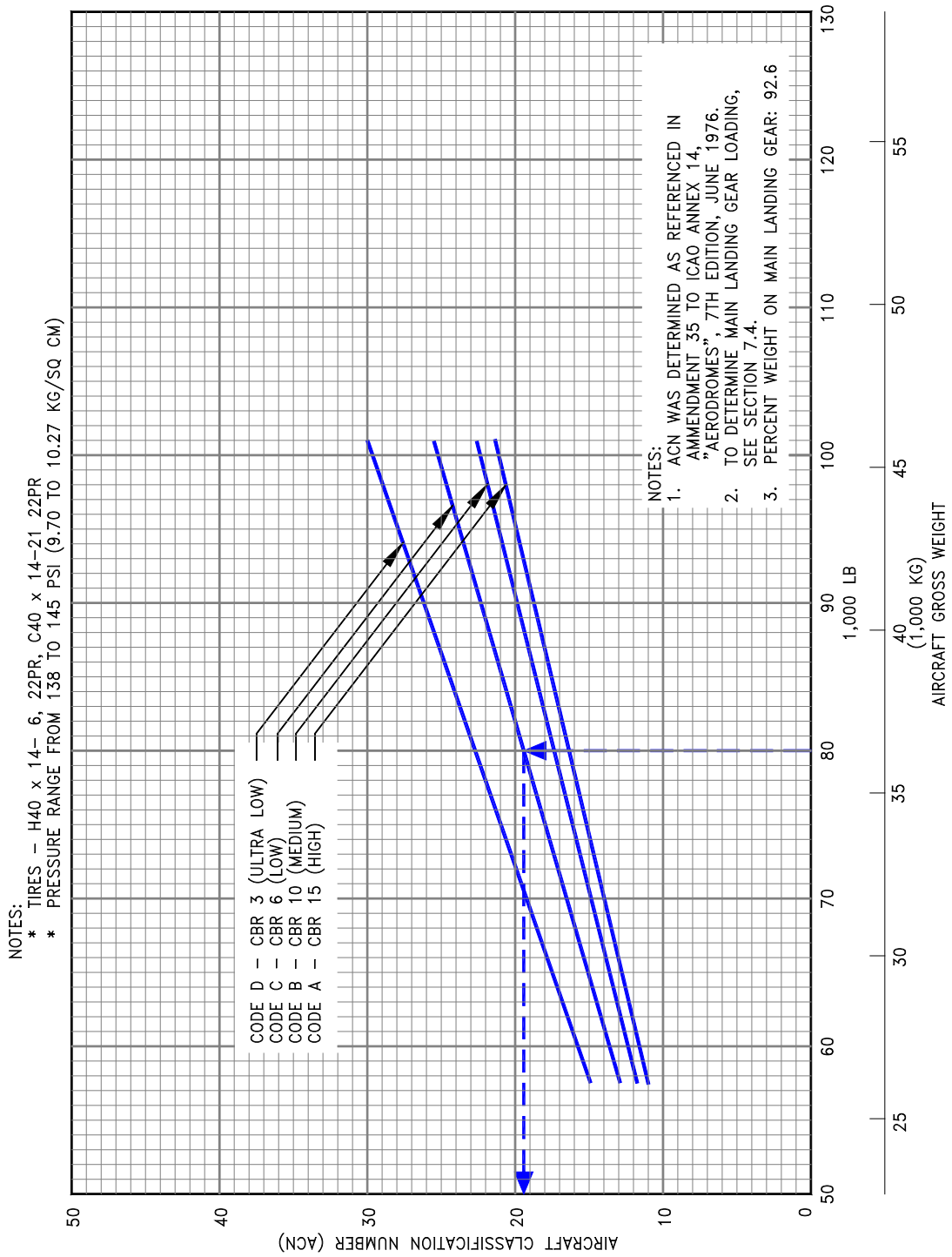

7.10.2 Aircraft Classification Number - Flexible Pavement: Model 737-100, -200, -200ADV at 110,000 to 117,500 LB (49,900 to 53,290 KG) MTW

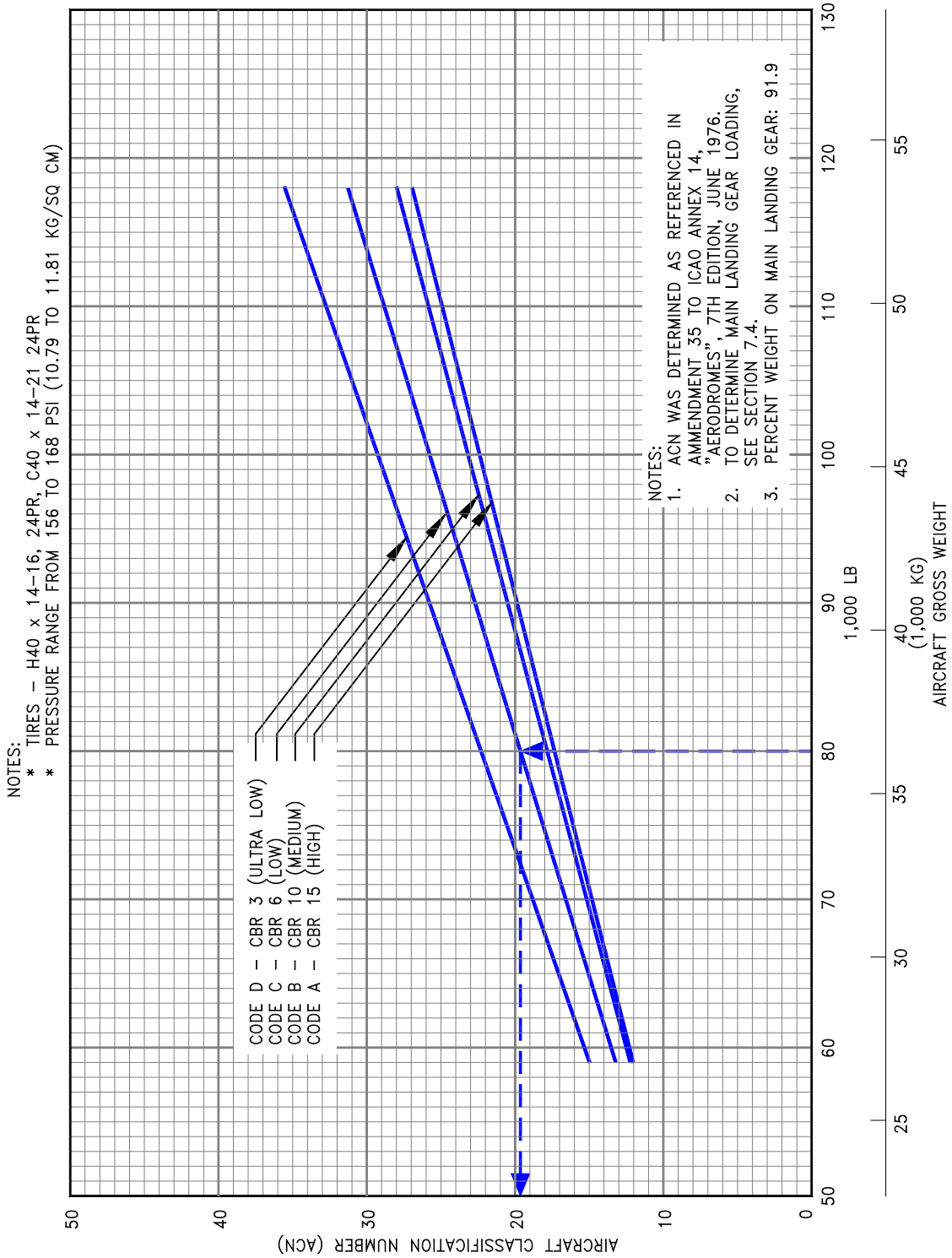

D6-58325-6

7.10.3 Aircraft Classification Number - Flexible Pavement: Model 737-100, -200, -200ADV at 110,000 to 117,500 LB (49,900 to 53,290 KG) MTW (Low Pressure Tires)

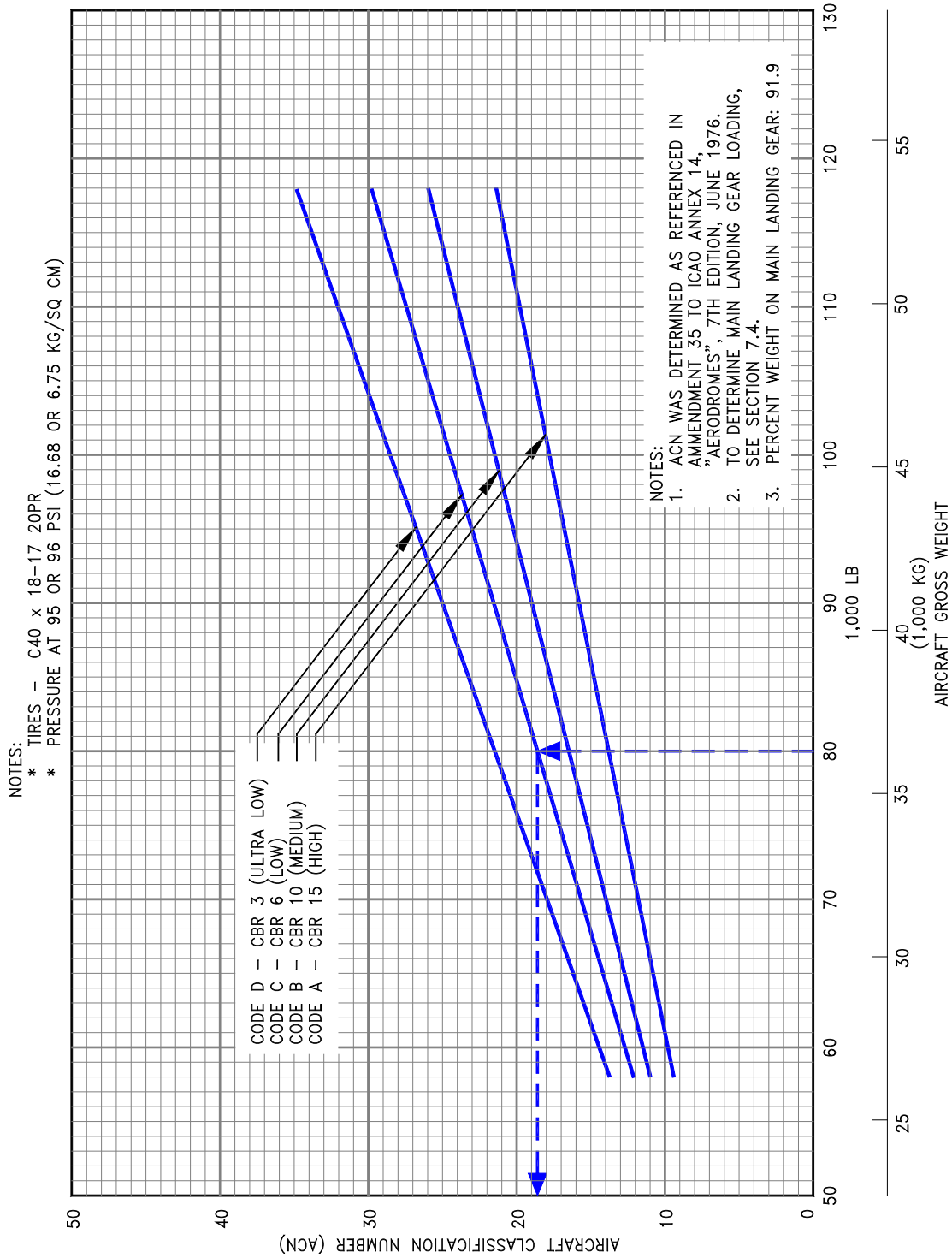

D6-58325-6

7.10.4 Aircraft Classification Number - Flexible Pavement: Model 737-200ADV at 120,000 to 128,600 LB (54,300 to 58,330 KG) MTW

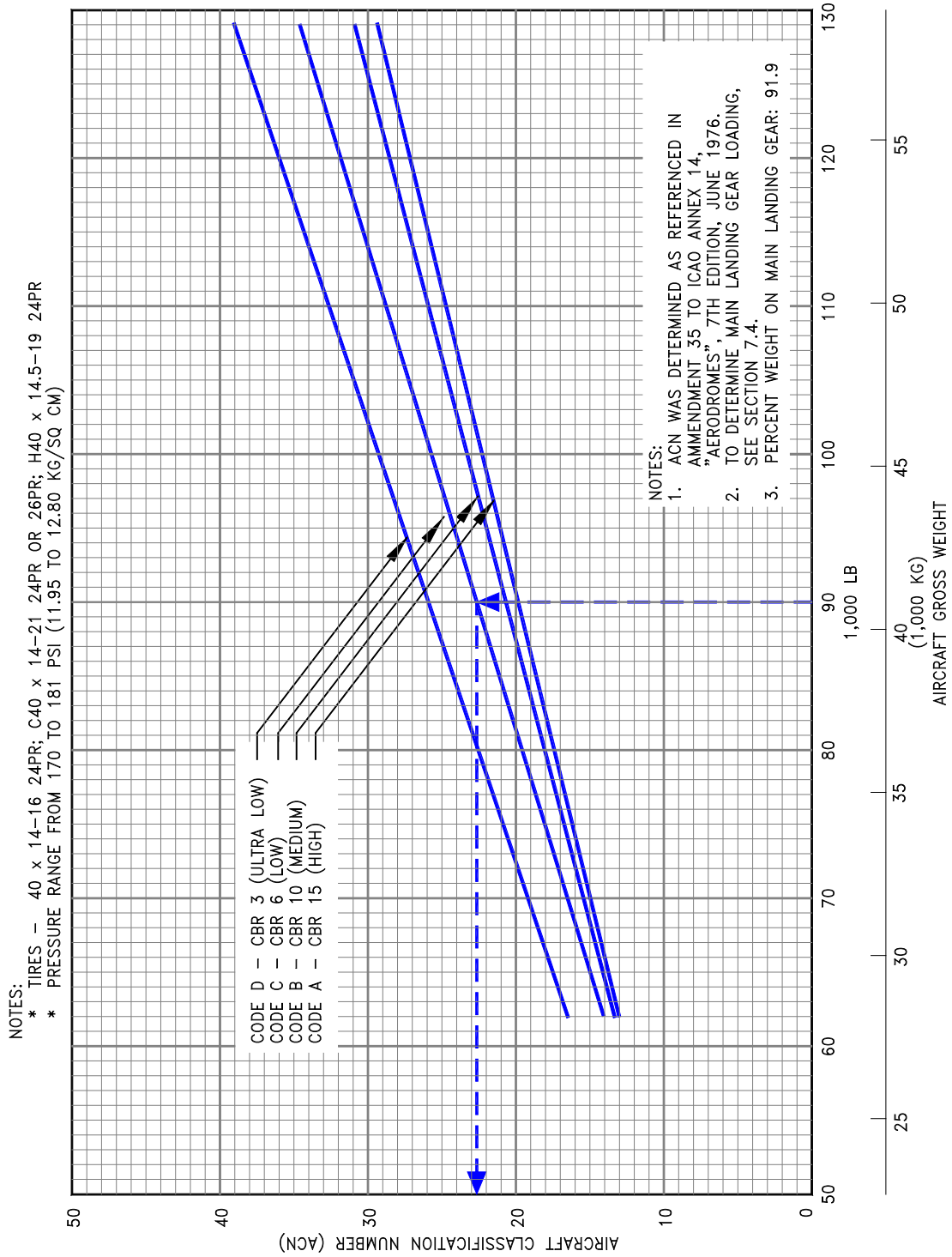

7.10.5 Aircraft Classification Number - Flexible Pavement: Model 737-300

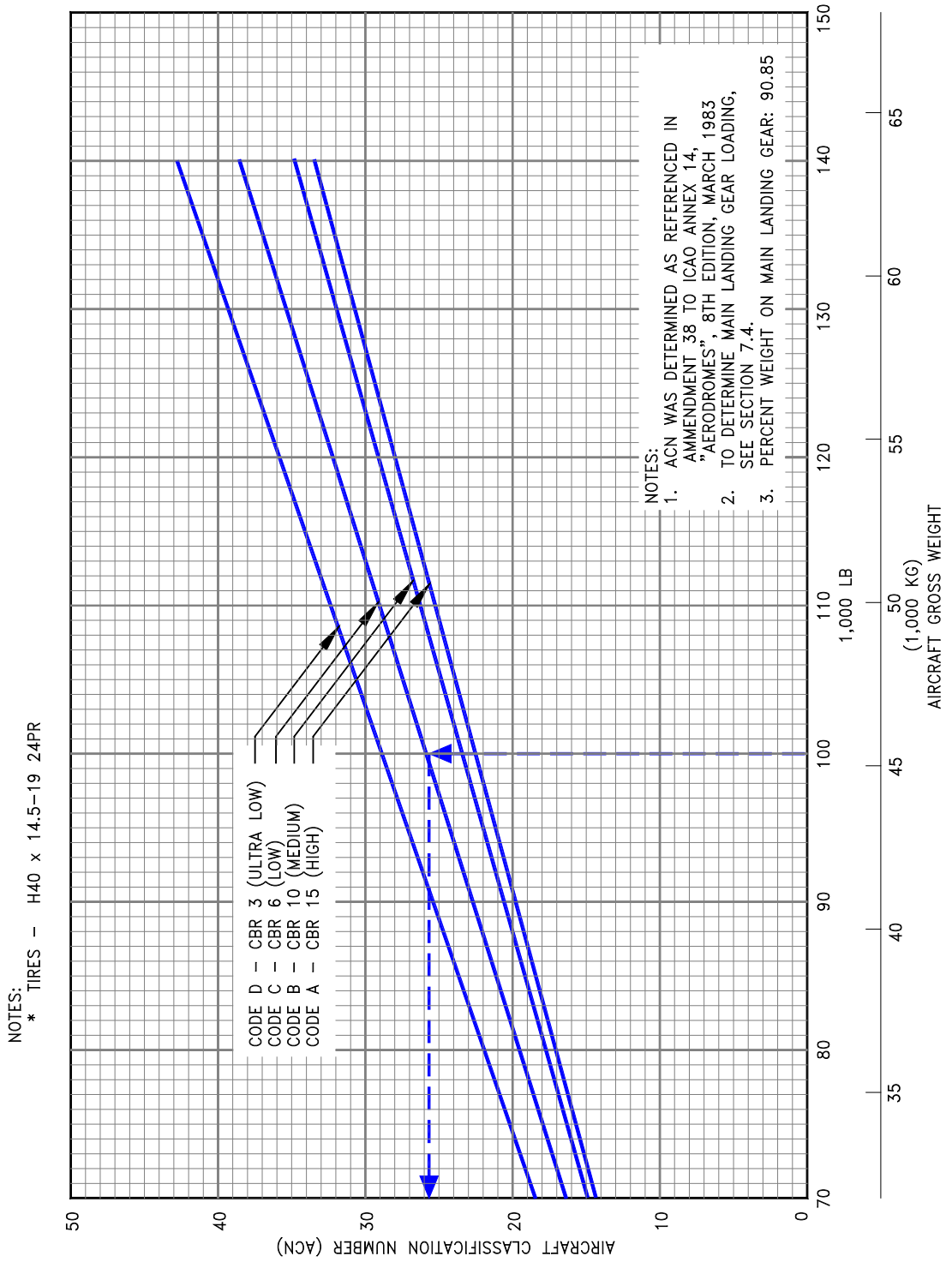

7.10.6 Aircraft Classification Number - Flexible Pavement: Model 737-300 (Low Pressure Tires)

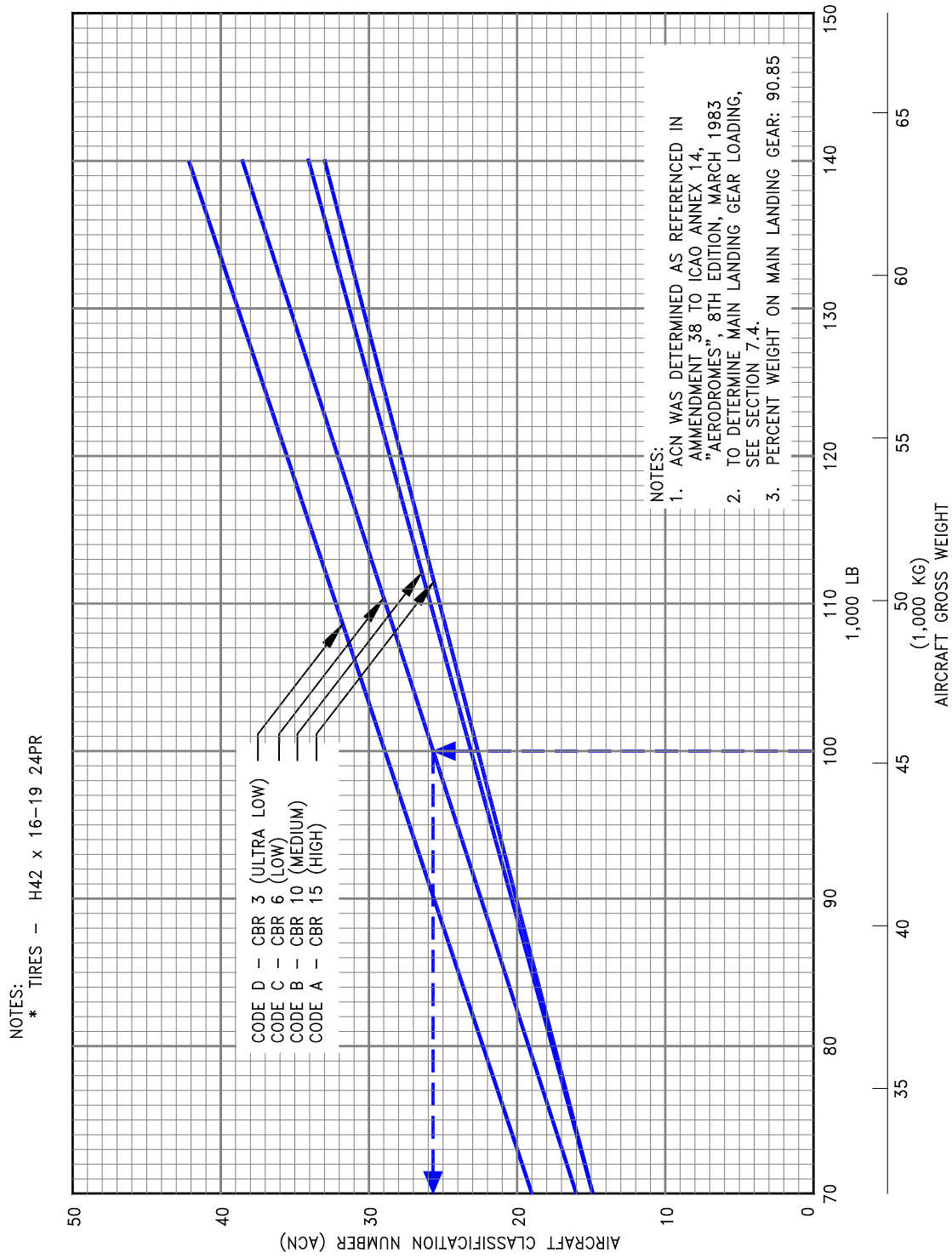

7.10.7 Aircraft Classification Number - Flexible Pavement: Model 737-400

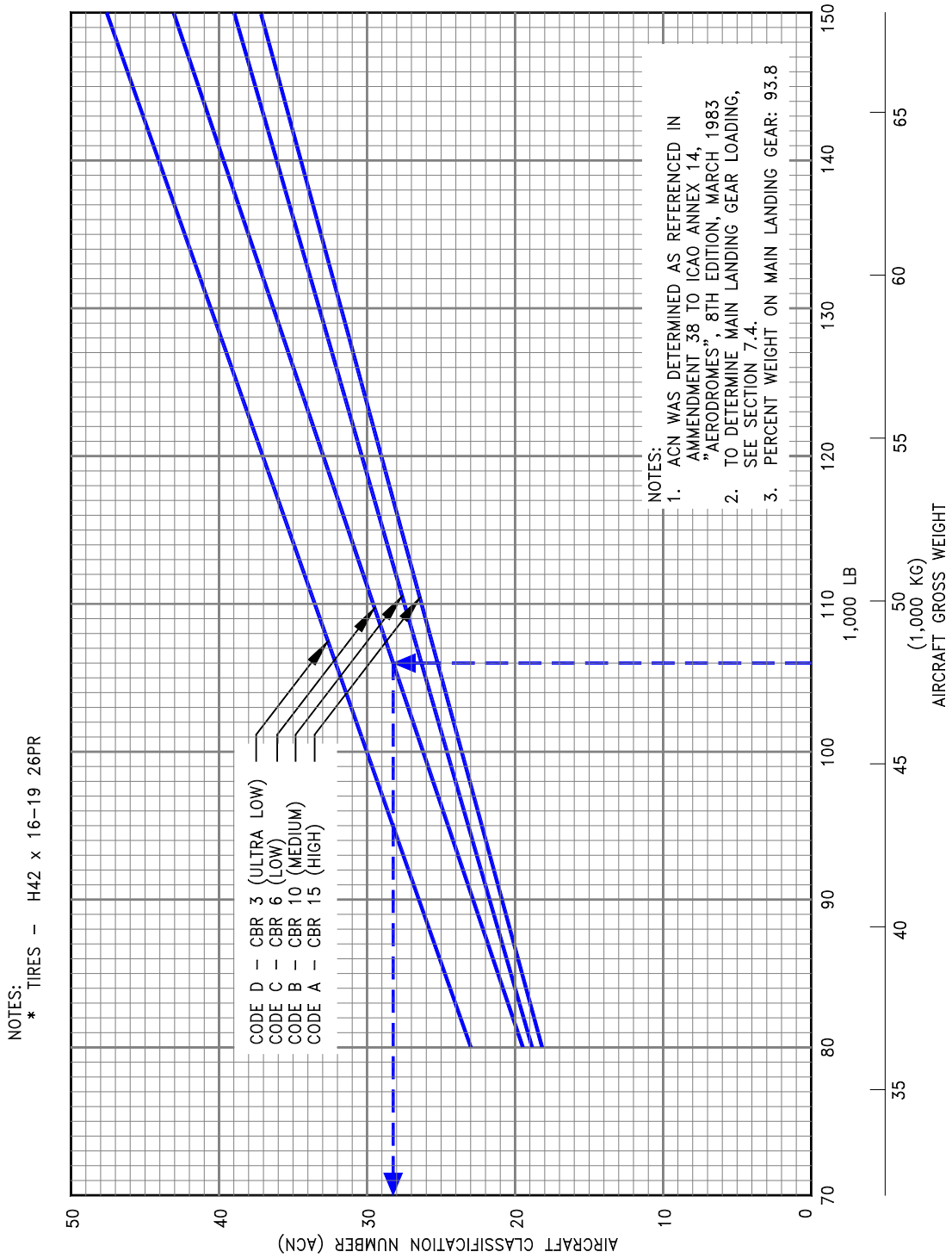

7.10.8 Aircraft Classification Number - Flexible Pavement: Model 737-400 (Low Pressure Tires)

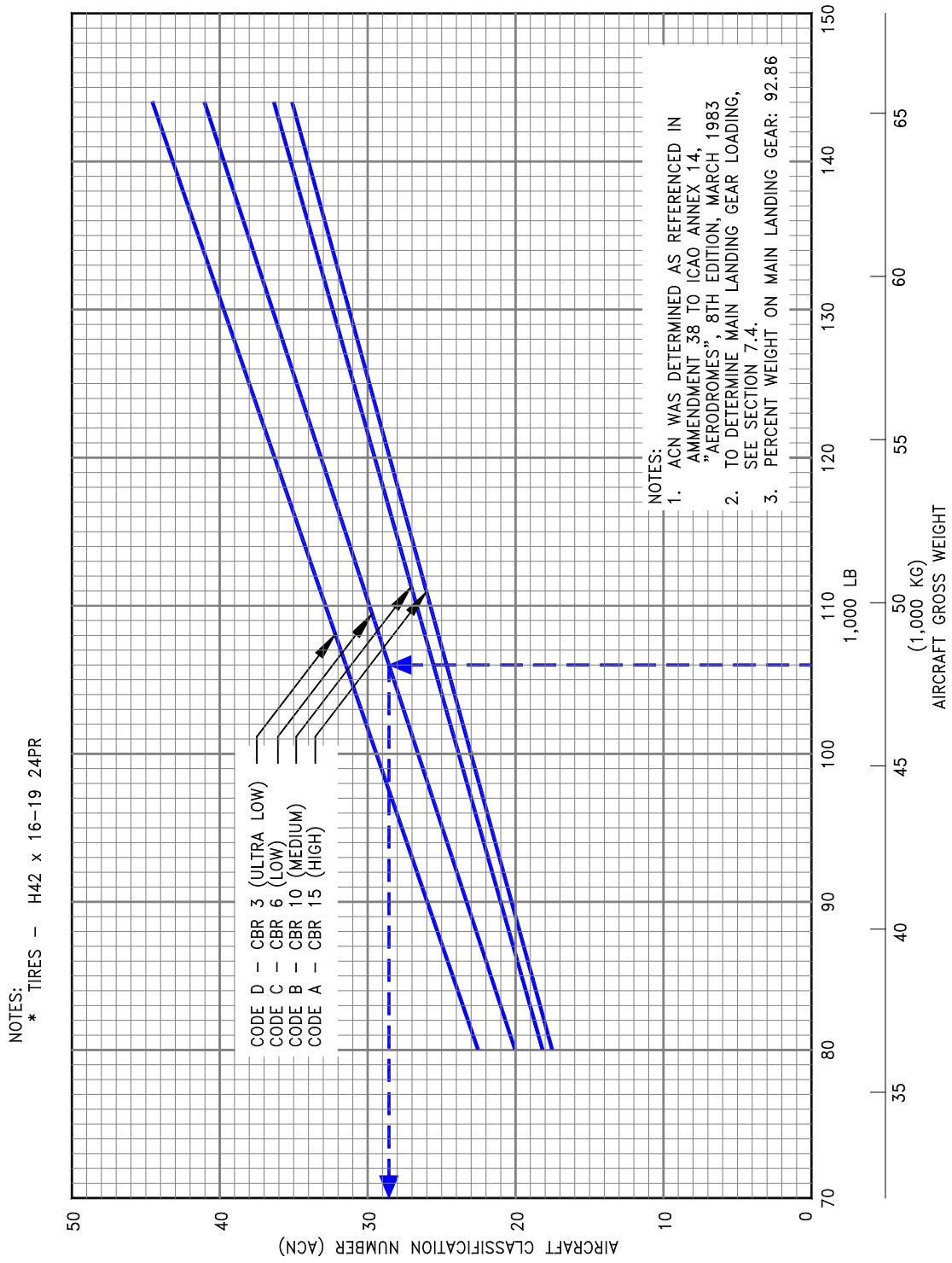

7.10.9 Aircraft Classification Number - Flexible Pavement: Model 737-500

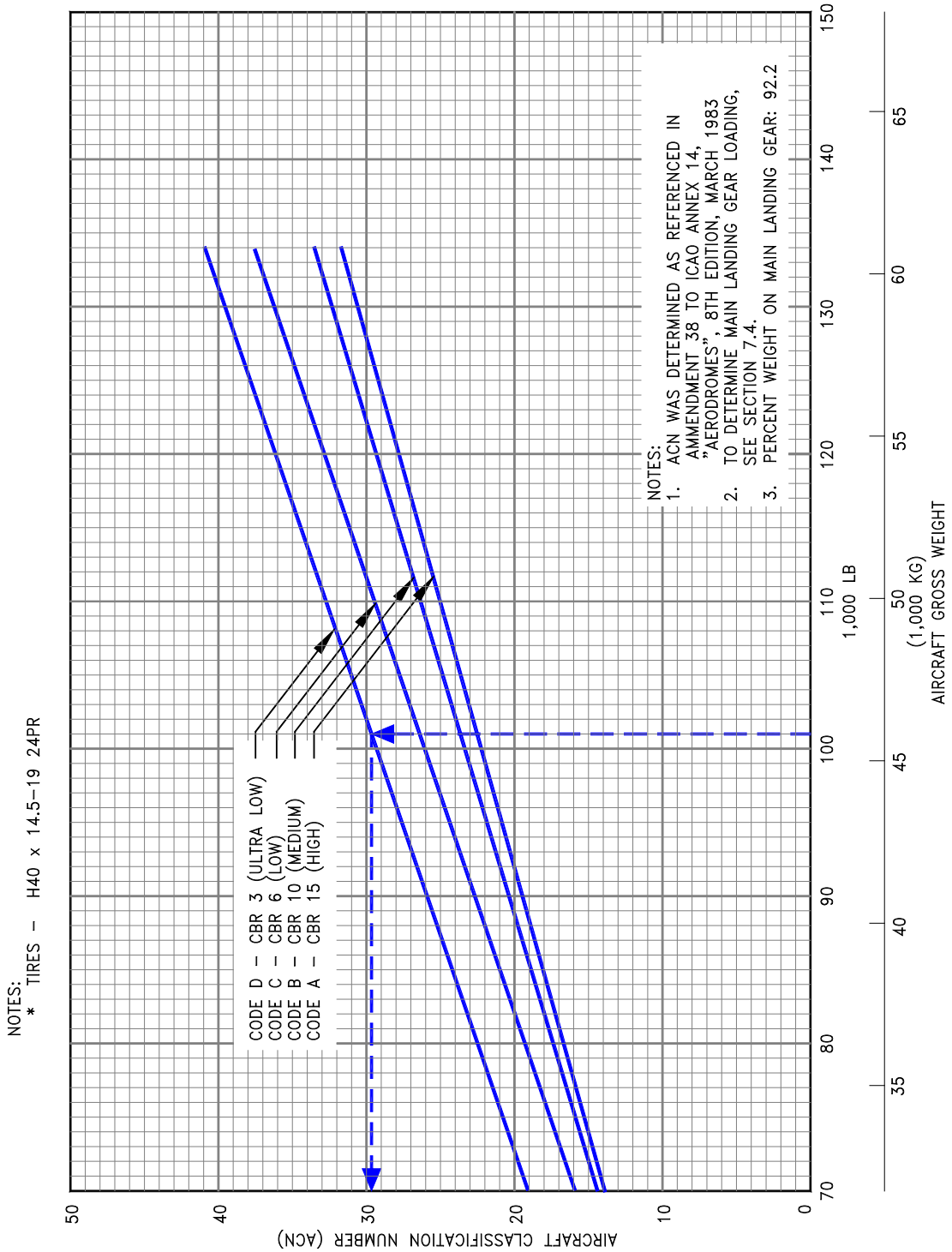

D6-58325-6

7.10.10 Aircraft Classification Number - Flexible Pavement: Model 737-500 (Low Pressure Tires)

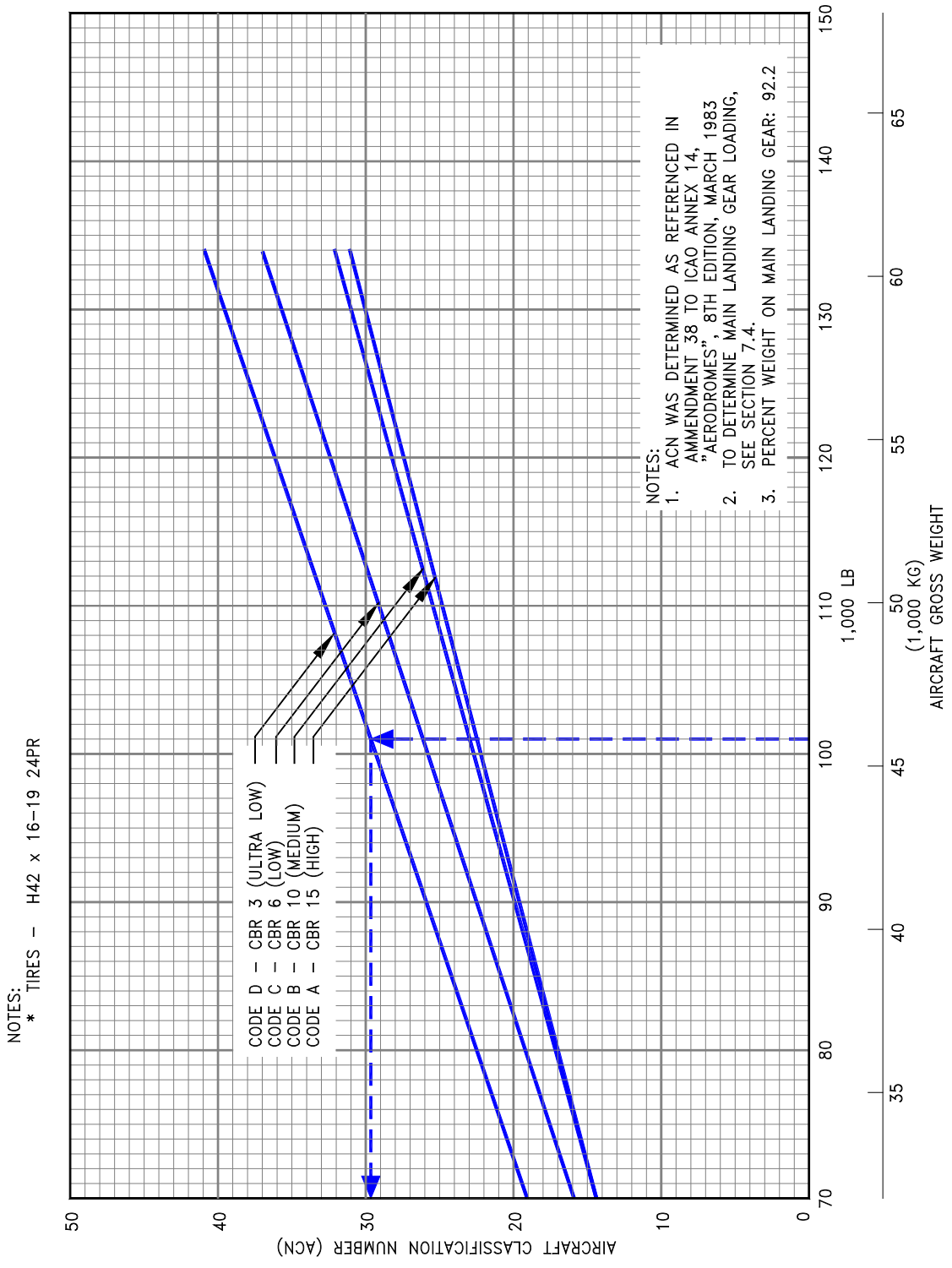

7.10.11 Aircraft Classification Number - Rigid Pavement: Model 737-100, -200 To 104,000 LB (47,170 KG) MTW

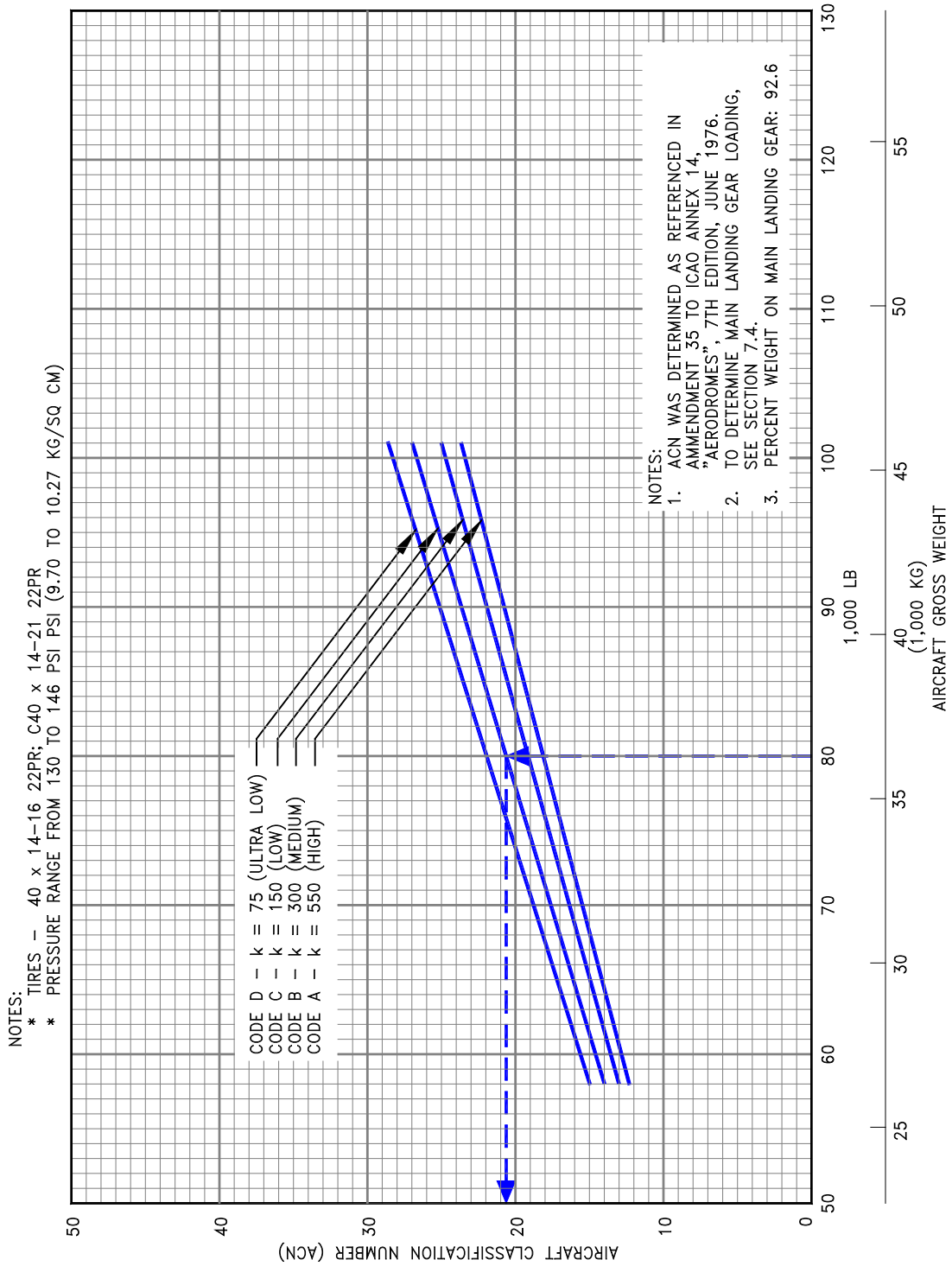

7.10.12 Aircraft Classification Number - Rigid Pavement: Model 737-100, -200, -200ADV at 110,000 to 117,500 LB (49,900 to 53,290 KG) MTW

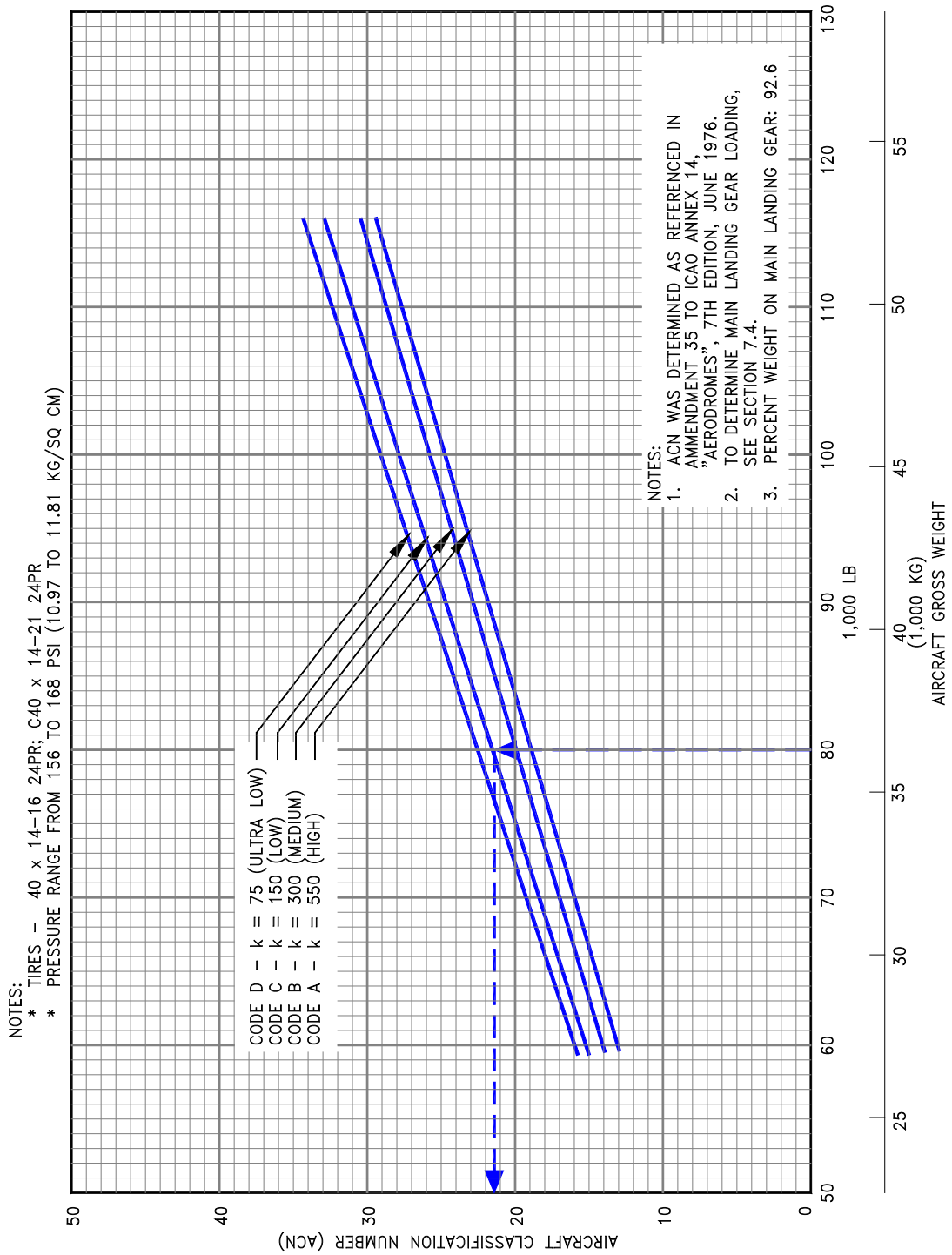

7.10.13 Aircraft Classification Number - Rigid Pavement: Model 737-100, -200, -200ADV at 110,000 to 117,500 LB (49,900 to 53,290 KG) MTW (Low Pressure Tires)

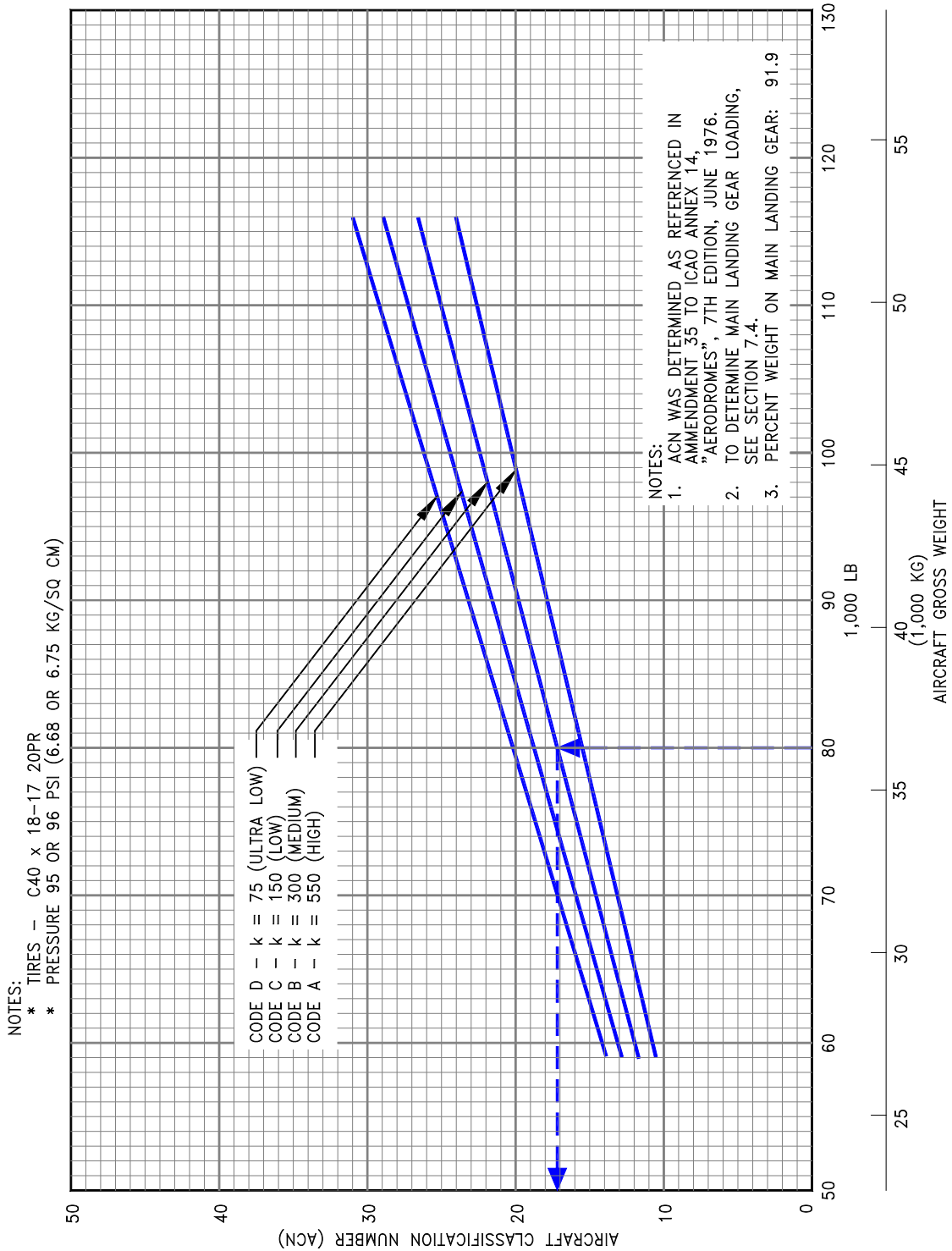

D6-58325-6

7.10.14 Aircraft Classification Number - Rigid Pavement: Model 737-200ADV at 120,000 to 128,600 LB (54,300 to 58,330 KG) MTW

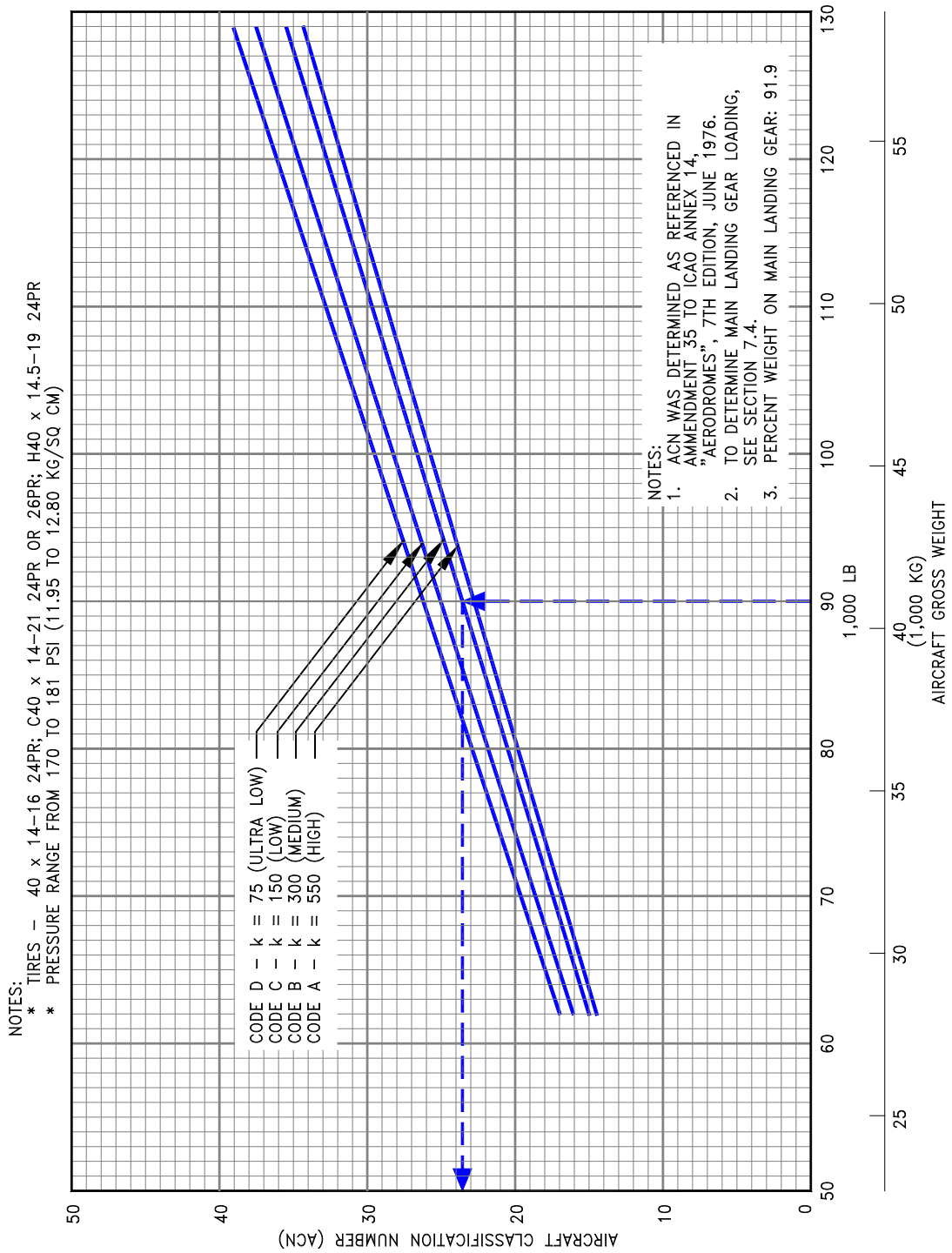

7.10.15 Aircraft Classification Number - Rigid Pavement: Model 737-300

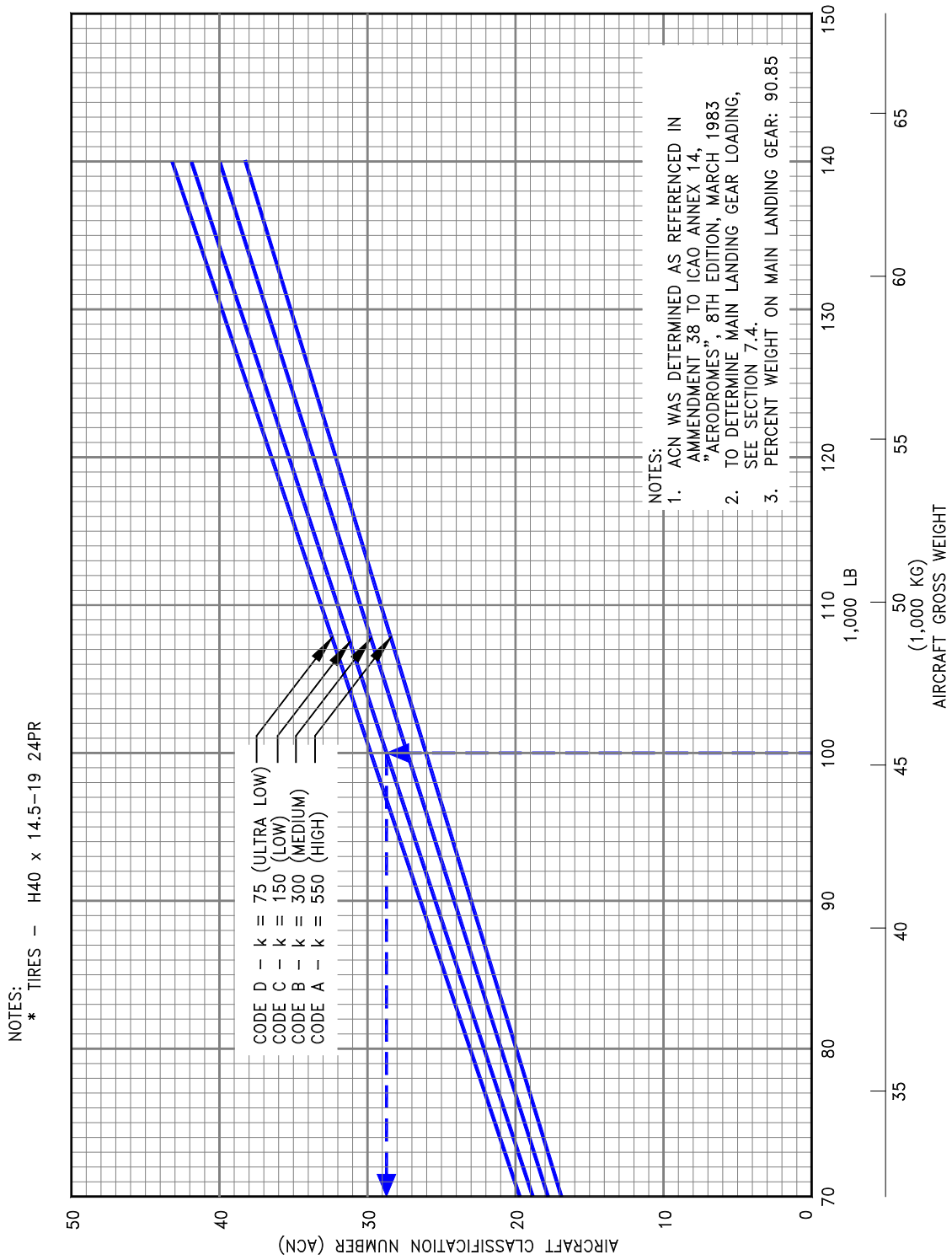

7.10.16 Aircraft Classification Number - Rigid Pavement: Model 737-300 (Low Pressure Tires)

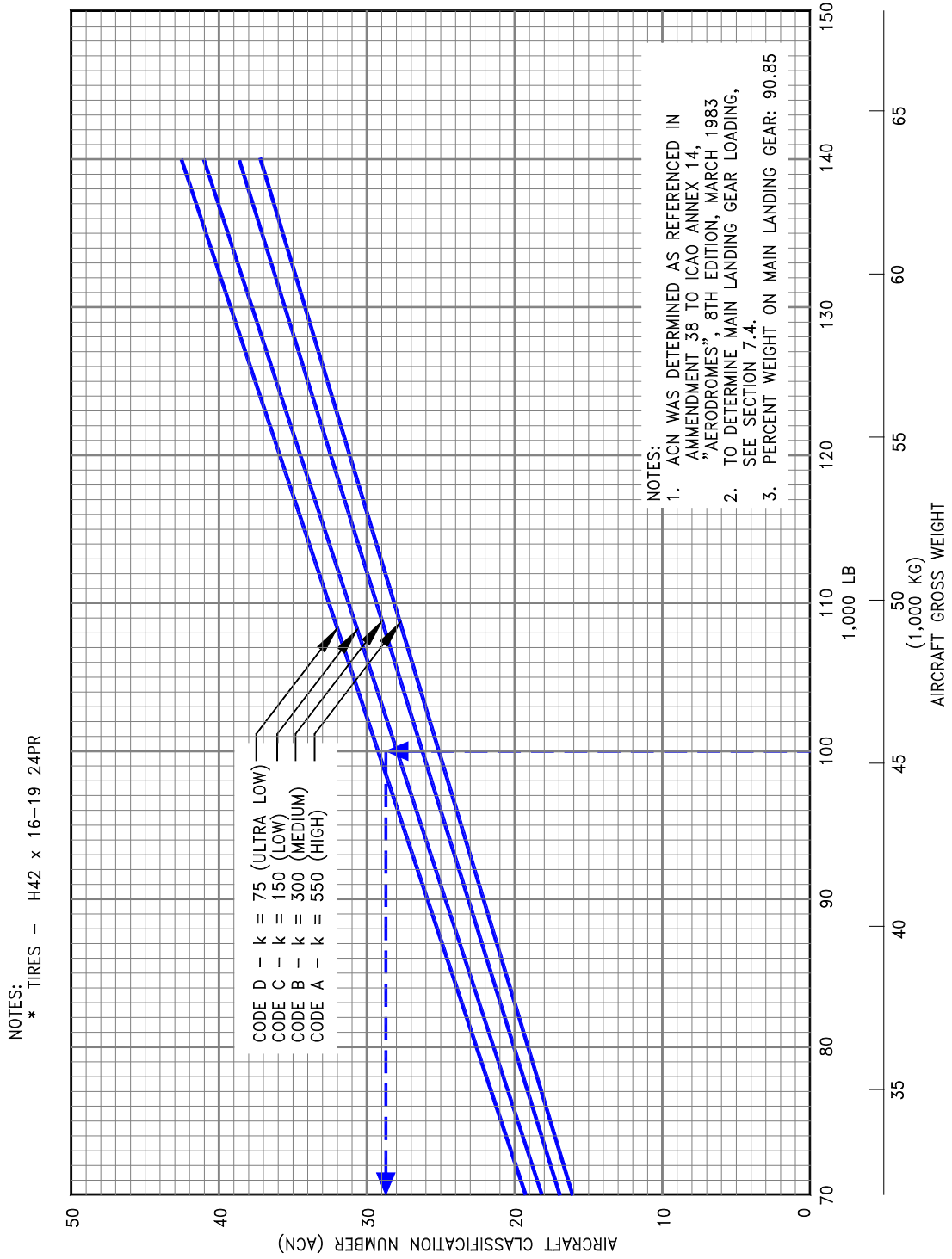

7.10.17 Aircraft Classification Number - Rigid Pavement: Model 737-400

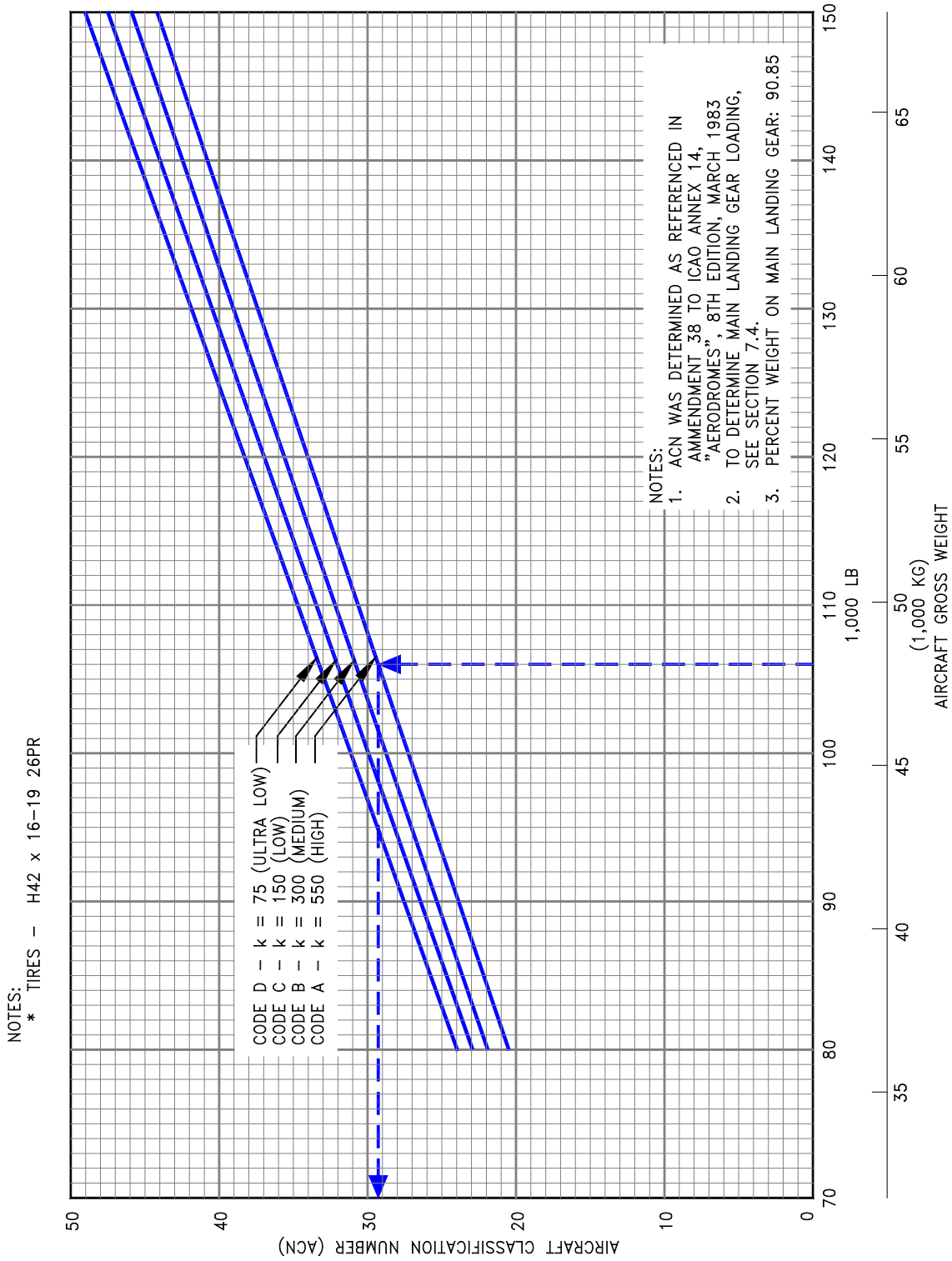

7.10.18 Aircraft Classification Number - Rigid Pavement: Model 737-400 (Low Pressure Tires)

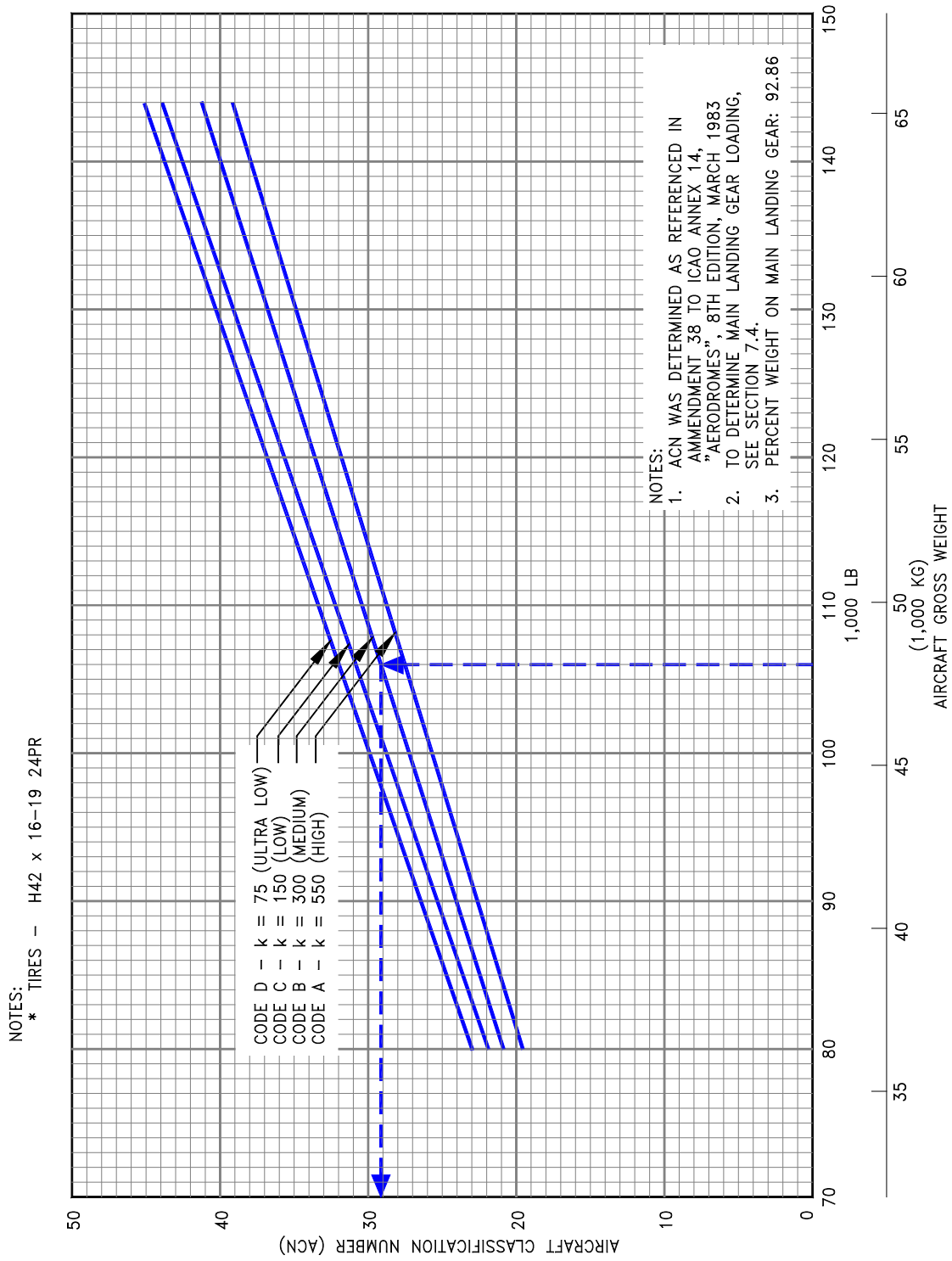

7.10.19 Aircraft Classification Number - Rigid Pavement: Model 737-500

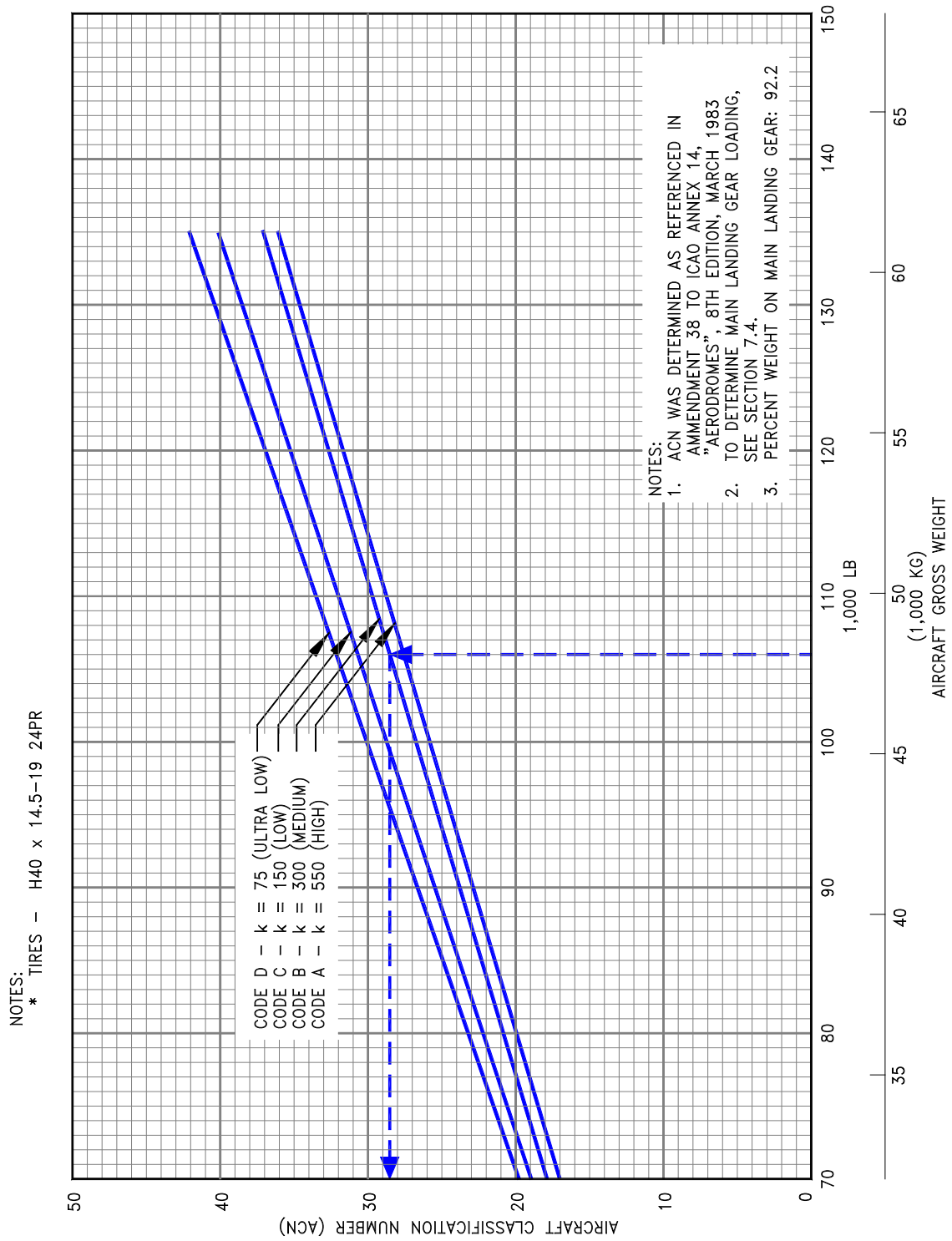

7.10.20 Aircraft Classification Number - Rigid Pavement: Model 737-500 (Low Pressure Tires)

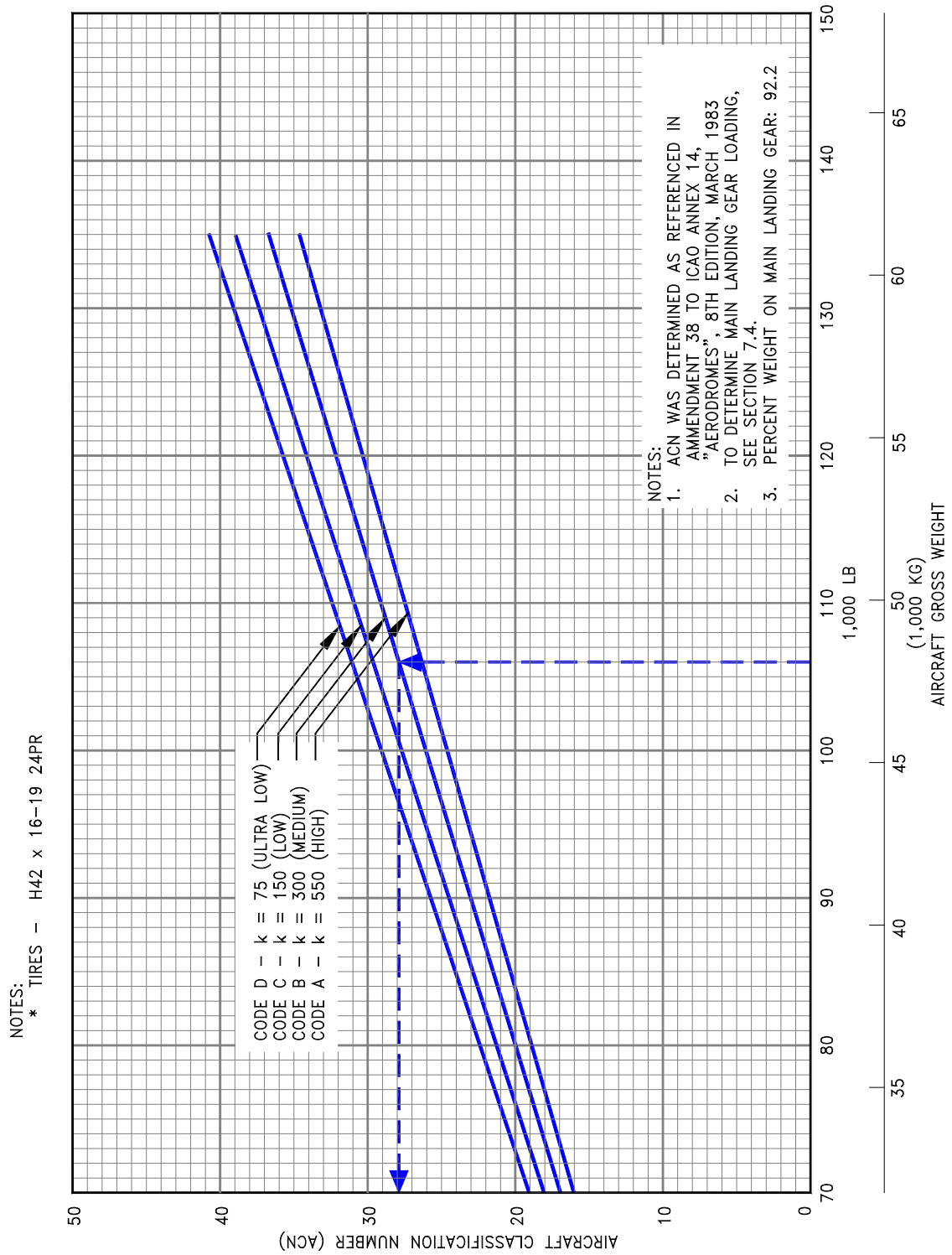

7.11 TIRE INFLATION CHART

7.11.1 Tire Inflation Chart: Model 737-100

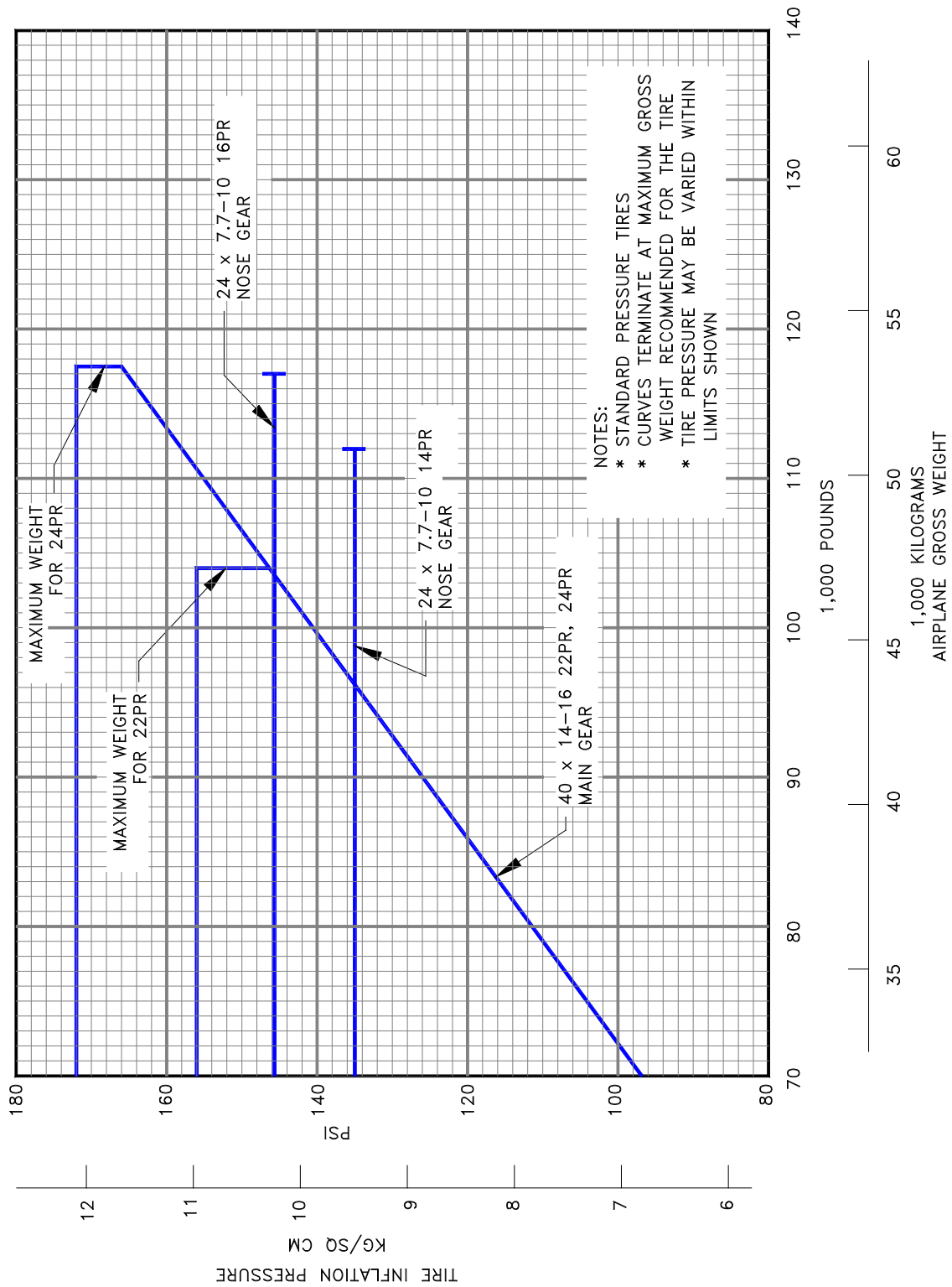

D6-58325-6

REV D

March 2023

7-67

7.11.2 Tire Inflation Chart: Model 737-100, -200

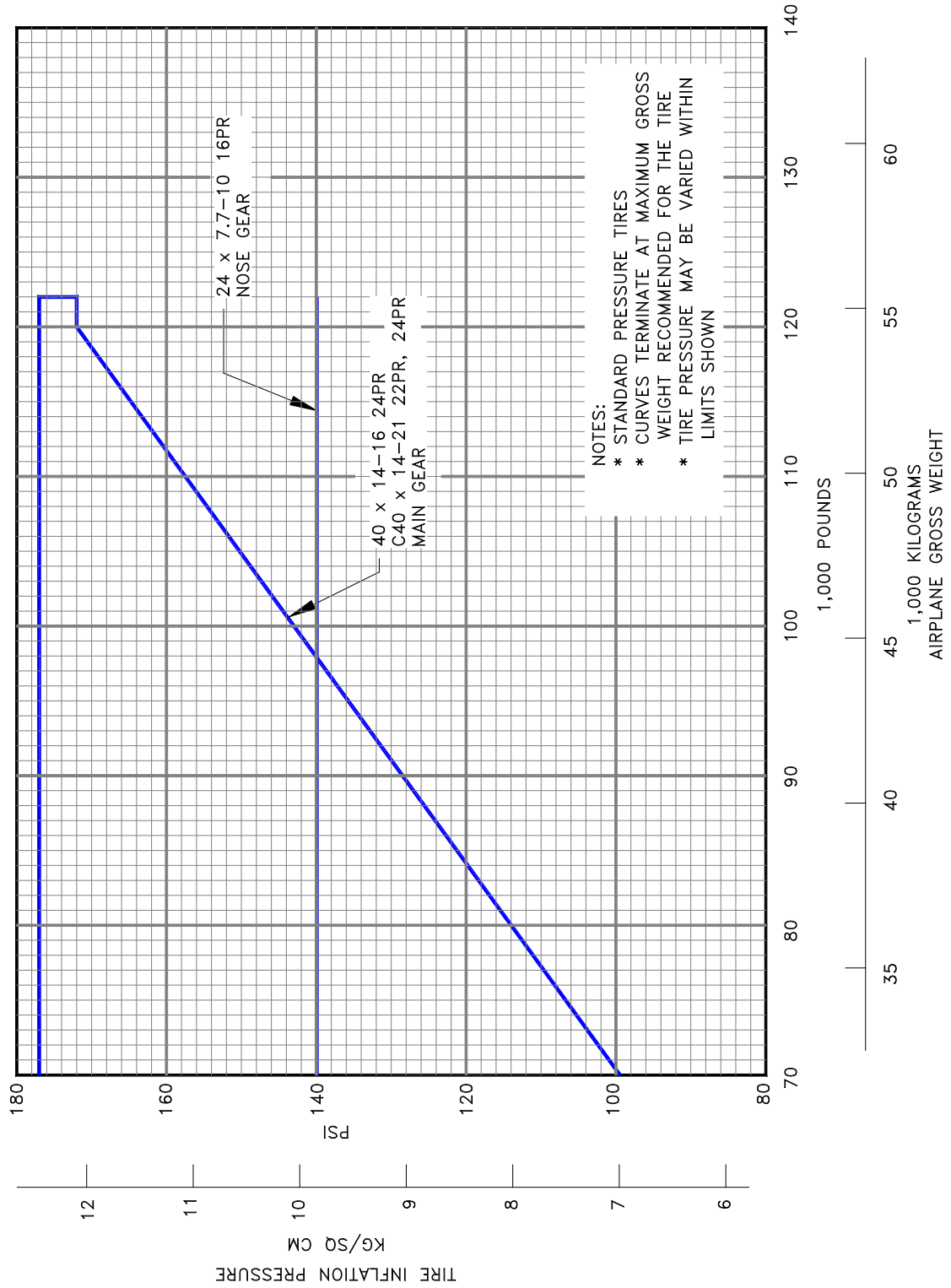

7.11.3 Tire Inflation Chart: Model ADV 737-200

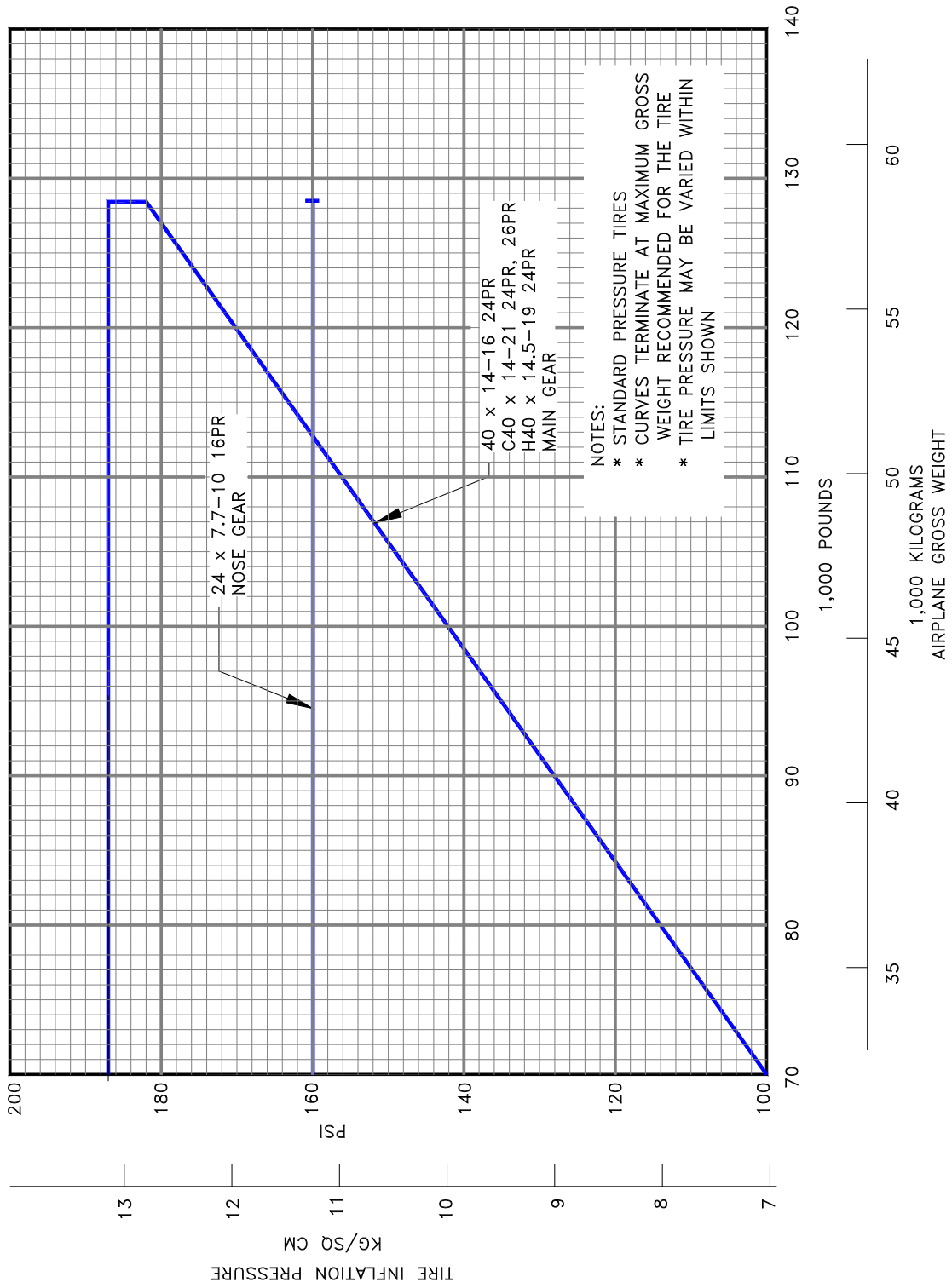

D6-58325-6

REV D

March 2023

7-69

7.11.4 Tire Inflation Chart: Model 737-200 (Low Pressure Tires)

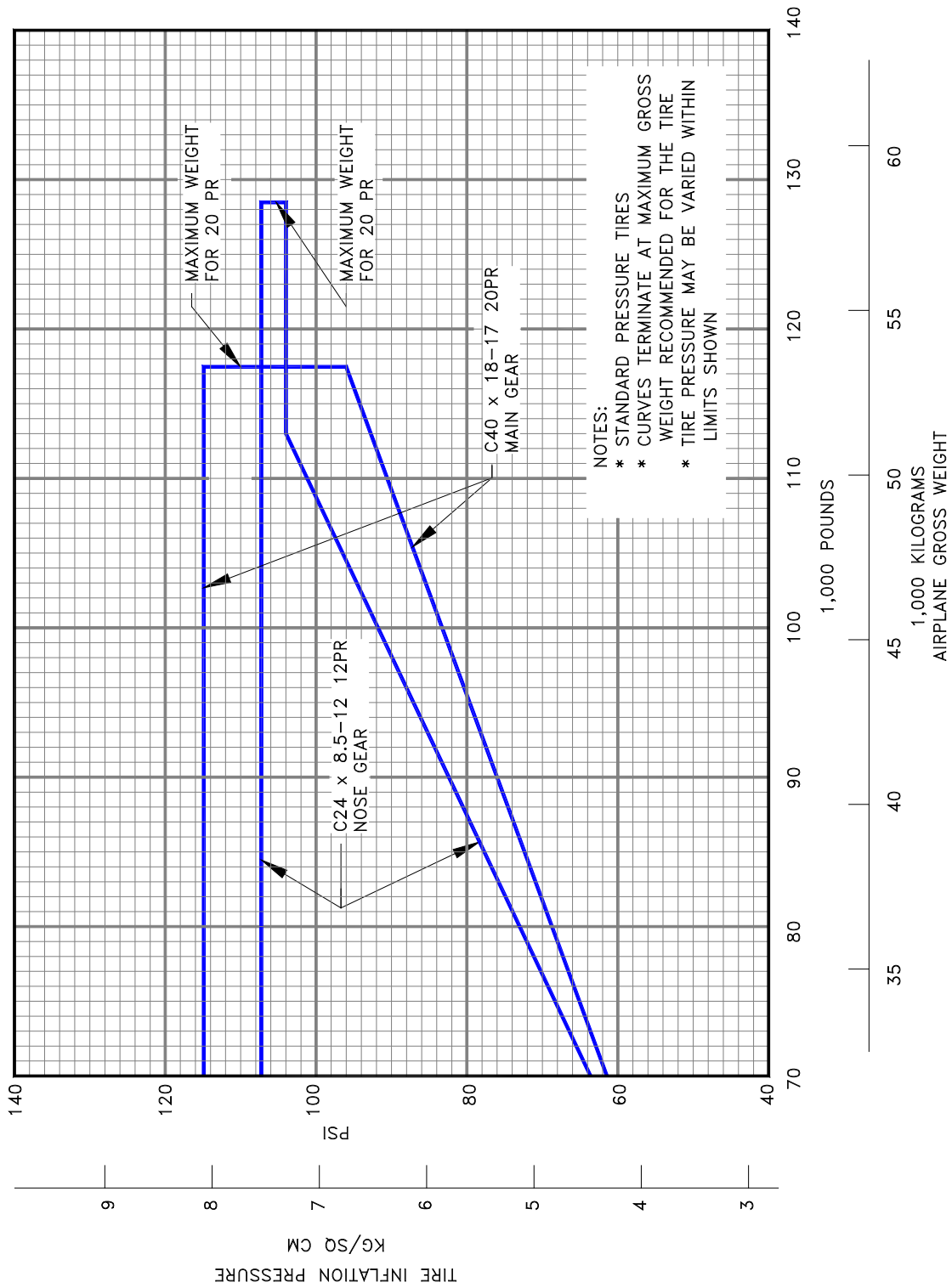

7.11.5 Tire Inflation Chart: Model 737-300

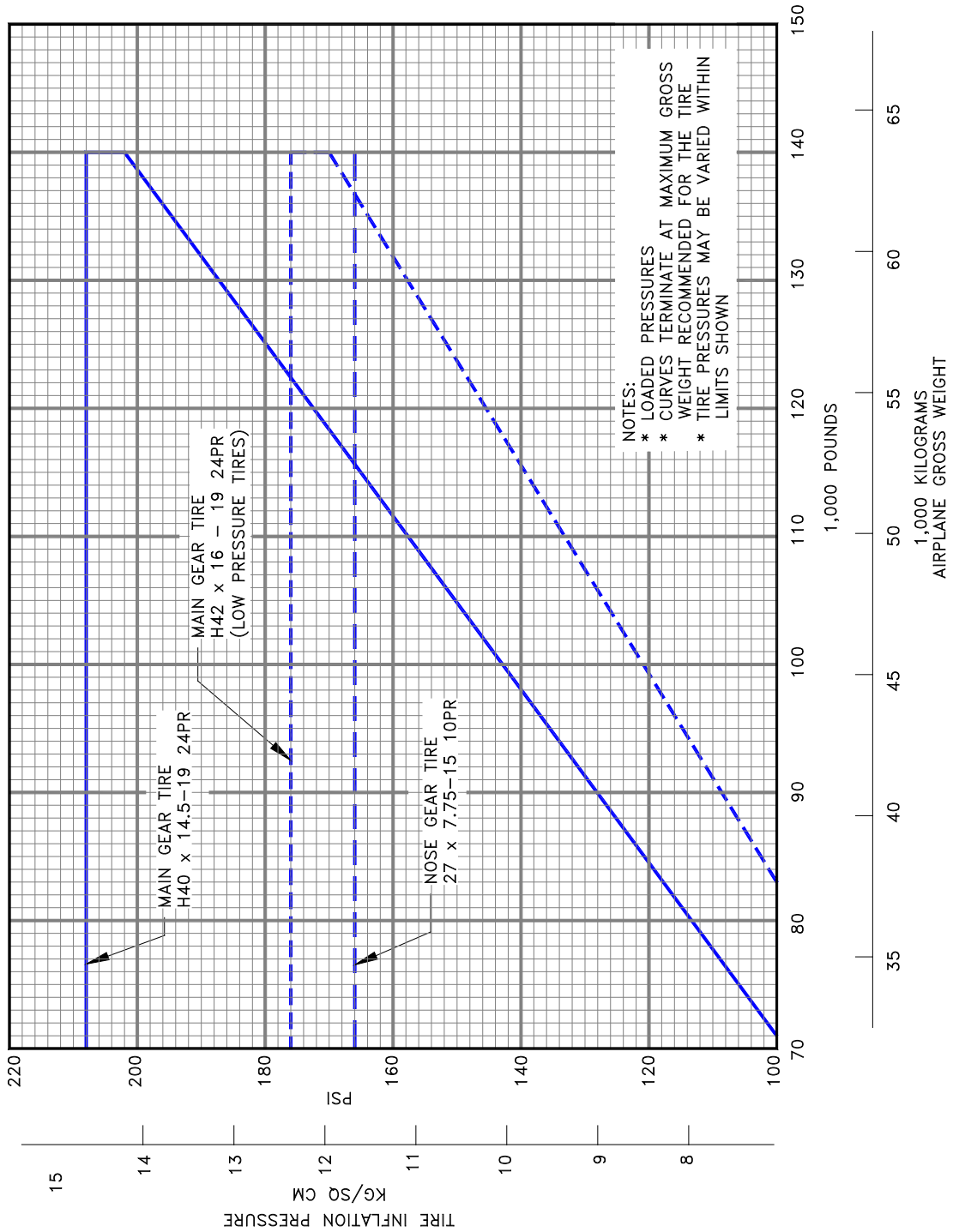

D6-58325-6

REV D

March 2023

7-71

7.11.6 Tire Inflation Chart: Model 737-400

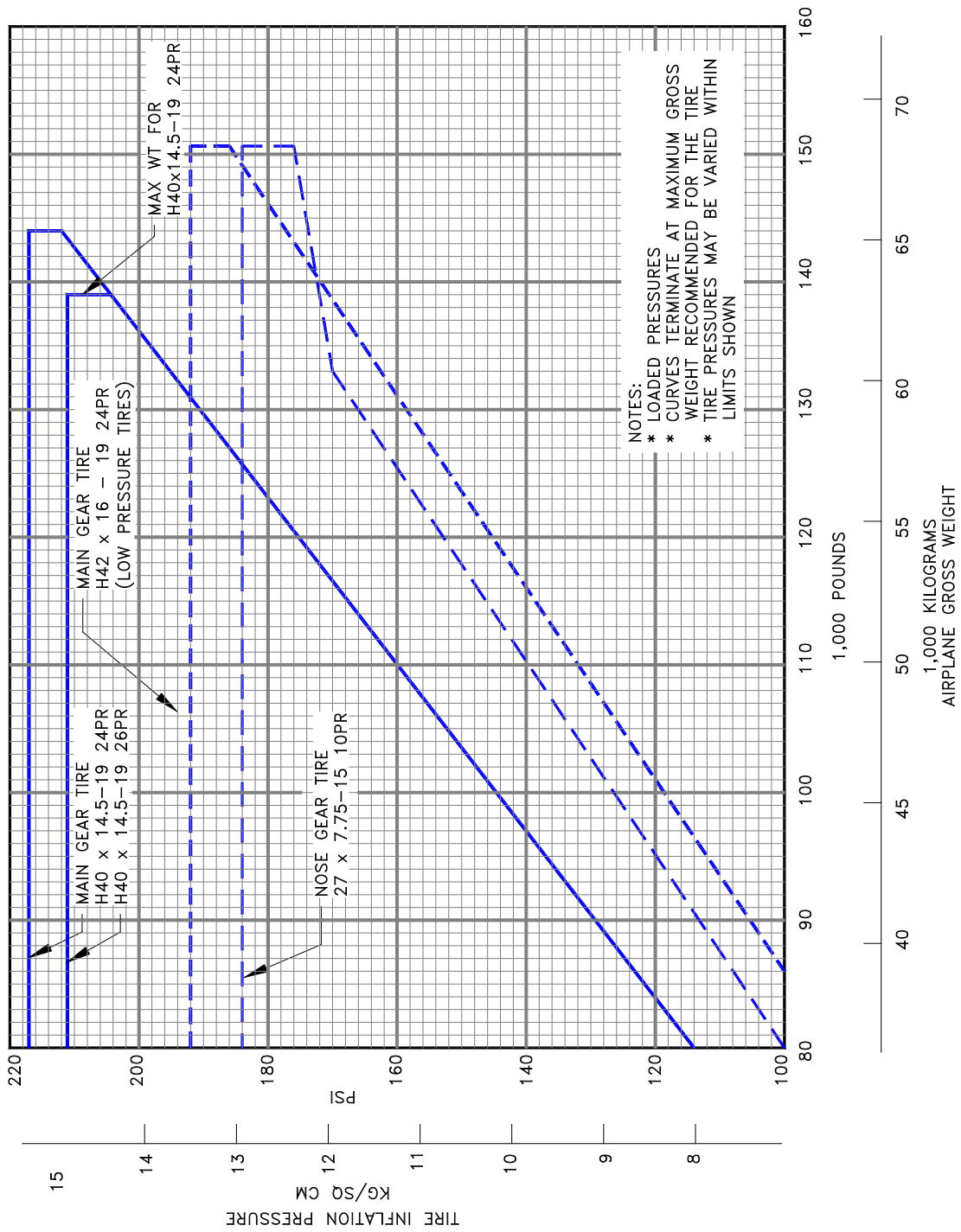

7.11.7 Tire Inflation Chart: Model 737-500

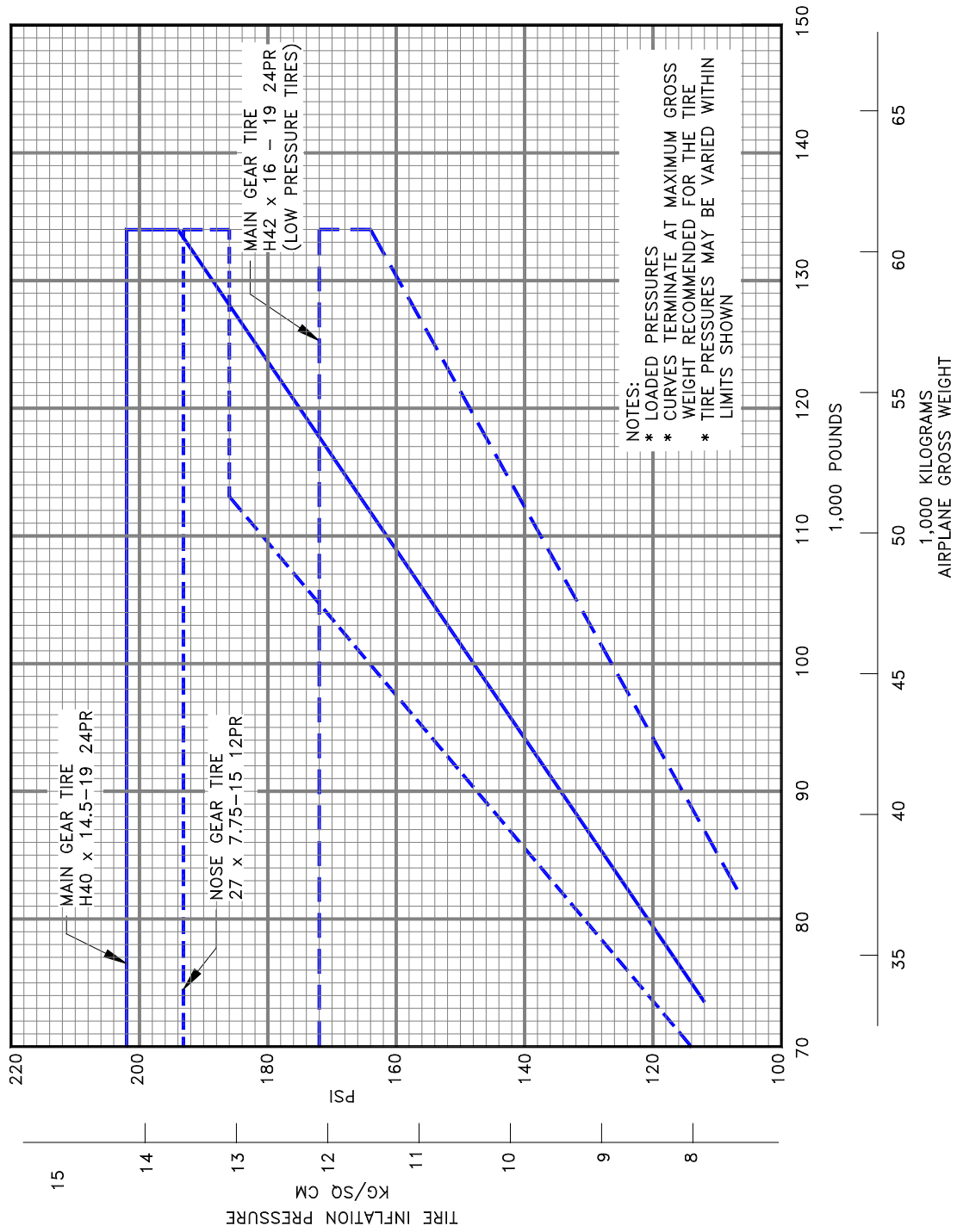

8.0 FUTURE 737 DERIVATIVE AIRPLANES

Development of these derivatives will depend on airline requirements. The impact of airline requirements on airport facilities will be a consideration in the configuration and design of these derivatives.

9.0 SCALED 737 DRAWINGS

The drawings in the following pages show airplane plan view drawings, drawn to approximate scale as noted. The drawings may not come out to exact scale when printed or copied from this document. Printing scale should be adjusted when attempting to reproduce these drawings. Three-view drawing files of the 737 airplane models, along with other Boeing airplane models, can be downloaded from the following website:

<http://www.boeing.com/airports>

9.1 MODEL 737-100

9.1.1 Scaled Drawings – 1 IN. = 32 FT: Model 737-100

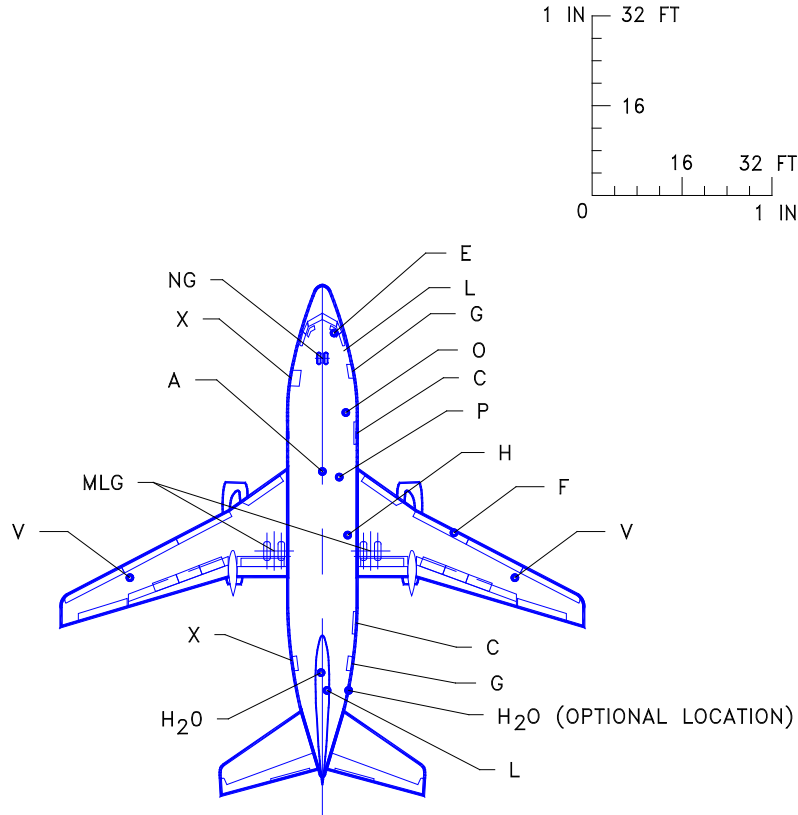

LEGEND

A	AIR CONDITIONING
C	CARGO DOOR
E	ELECTRICAL
F	FUEL
G	SERVICE DOOR
H ₂ O	POTABLE WATER
L	LAVATORY SERVICE
MLG	MAIN LANDING GEAR
NG	NOSE LANDING GEAR
O	OXYGEN
P	PNEUMATIC (AIR START)
V	FUEL VENT
X	PASSENGER DOOR

NOTE: FOR TURNING RADIUS DATA
SEE SECTIONS 4.2 AND 4.3

NOTE: WHEN PRINTING THIS DRAWING, MAKE SURE TO ADJUST FOR PROPER SCALING

D6-58325-6

REV D

March 2023

9-2

9.1.2 Scaled Drawings – 1 IN. = 32 FT: Model 737-100

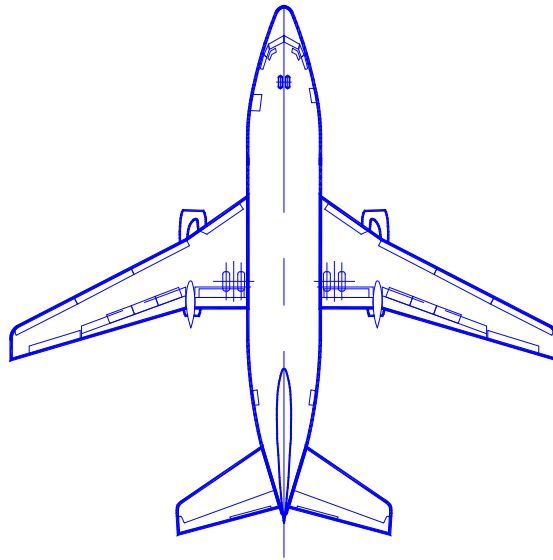
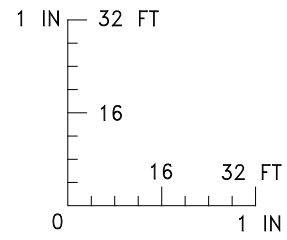

NOTE: WHEN PRINTING THIS DRAWING, MAKE SURE TO ADJUST FOR PROPER SCALING

9.1.3 Scaled Drawings – 1 IN. = 50 FT: Model 737-100

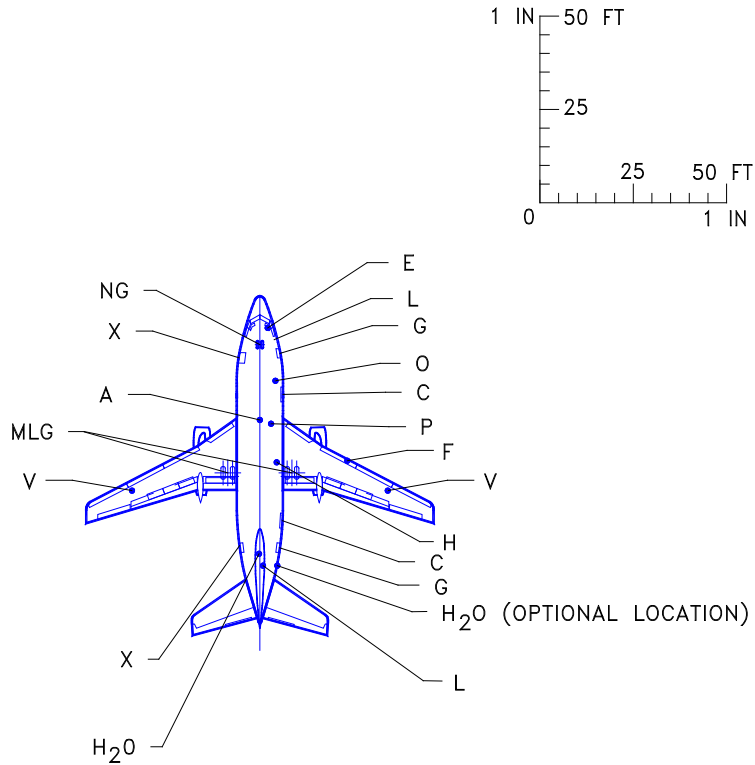

LEGEND

- A AIR CONDITIONING
- C CARGO DOOR
- E ELECTRICAL
- F FUEL
- G SERVICE DOOR
- H₂O POTABLE WATER
- L LAVATORY SERVICE
- MLG MAIN LANDING GEAR
- NG NOSE LANDING GEAR
- O OXYGEN
- P PNEUMATIC (AIR START)
- V FUEL VENT
- X PASSENGER DOOR

NOTE: FOR TURNING RADIUS DATA
SEE SECTIONS 4.2 AND 4.3

NOTE: WHEN PRINTING THIS DRAWING, MAKE SURE TO ADJUST FOR PROPER SCALING

D6-58325-6

REV D

March 2023

9-4

9.1.4 Scaled Drawings – 1 IN. = 50 FT: Model 737-100

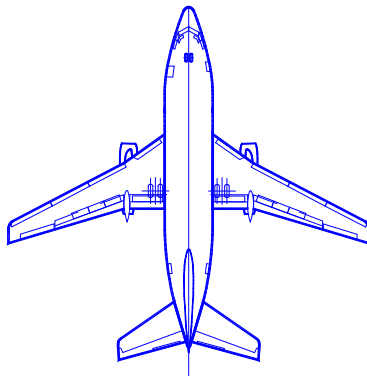
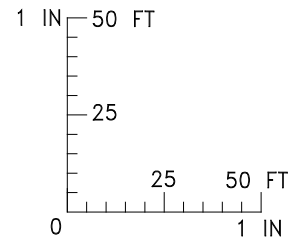

NOTE: WHEN PRINTING THIS DRAWING, MAKE SURE TO ADJUST FOR PROPER SCALING

9.1.5 Scaled Drawings – 1 IN. = 100 FT: Model 737-100

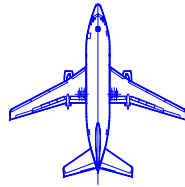
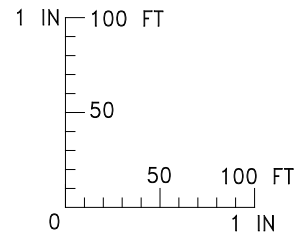

NOTE:

SEE CORRESPONDING PAGE FOR 1 IN = 32 FT
FOR IDENTIFICATIONS OF SERVICE POINTS

LEGEND

A	AIR CONDITIONING
C	CARGO DOOR
E	ELECTRICAL
F	FUEL
G	SERVICE DOOR
H ₂ O	POTABLE WATER
L	LAVATORY SERVICE
MLG	MAIN LANDING GEAR
NG	NOSE LANDING GEAR
O	OXYGEN
P	PNEUMATIC (AIR START)
V	FUEL VENT
X	PASSENGER DOOR

NOTE: FOR TURNING RADIUS DATA
SEE SECTIONS 4.2 AND 4.3

NOTE: WHEN PRINTING THIS DRAWING, MAKE SURE TO ADJUST FOR PROPER SCALING

D6-58325-6

REV D

March 2023

9-6

9.1.6 Scaled Drawings – 1 IN. = 100 FT: Model 737-100

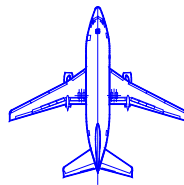
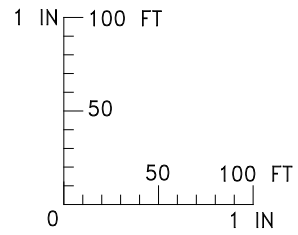

NOTE: WHEN PRINTING THIS DRAWING, MAKE SURE TO ADJUST FOR PROPER SCALING

9.1.7 Scaled Drawings – 1:500: Model 737-100

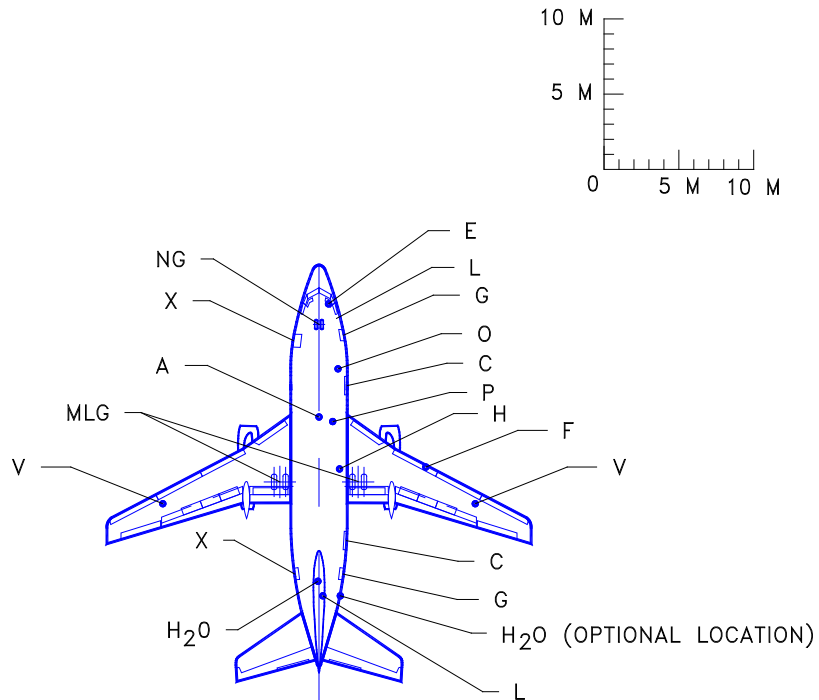

LEGEND

A	AIR CONDITIONING
C	CARGO DOOR
E	ELECTRICAL
F	FUEL
G	SERVICE DOOR
H ₂ O	POTABLE WATER
L	LAVATORY SERVICE
MLG	MAIN LANDING GEAR
NG	NOSE LANDING GEAR
O	OXYGEN
P	PNEUMATIC (AIR START)
V	FUEL VENT
X	PASSENGER DOOR

NOTE: FOR TURNING RADIUS DATA
SEE SECTIONS 4.2 AND 4.3

NOTE: WHEN PRINTING THIS DRAWING, MAKE SURE TO ADJUST FOR PROPER SCALING

D6-58325-6

REV D

March 2023

9-8

9.1.8 Scaled Drawings – 1:500: Model 737-100

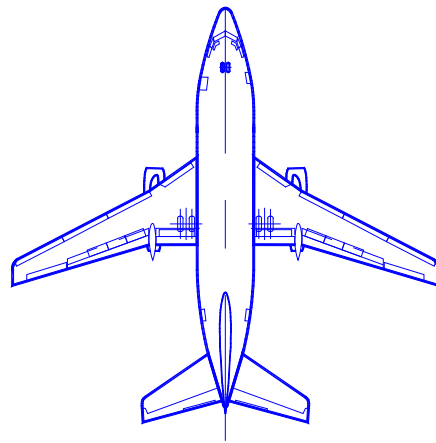
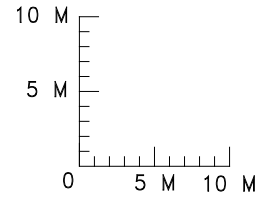

NOTE: WHEN PRINTING THIS DRAWING, MAKE SURE TO ADJUST FOR PROPER SCALING

9.1.9 Scaled Drawings – 1:1000: Model 737-100

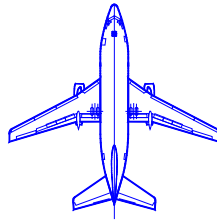
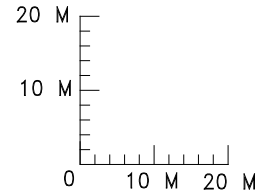

NOTE:

SEE CORRESPONDING PAGE FOR 1 IN = 32 FT
FOR IDENTIFICATIONS OF SERVICE POINTS

LEGEND

A	AIR CONDITIONING
C	CARGO DOOR
E	ELECTRICAL
F	FUEL
G	SERVICE DOOR
H ₂ O	POTABLE WATER
L	LAVATORY SERVICE
MLG	MAIN LANDING GEAR
NG	NOSE LANDING GEAR
O	OXYGEN
P	PNEUMATIC (AIR START)
V	FUEL VENT
X	PASSENGER DOOR

NOTE: FOR TURNING RADIUS DATA
SEE SECTIONS 4.2 AND 4.3

NOTE: WHEN PRINTING THIS DRAWING, MAKE SURE TO ADJUST FOR PROPER SCALING

D6-58325-6

REV D

March 2023

9-10

9.1.10 Scaled Drawings – 1:1000: Model 737-100

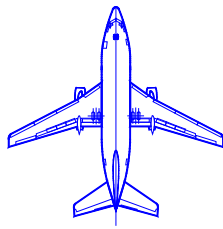
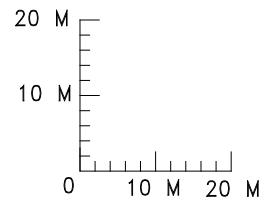

NOTE: WHEN PRINTING THIS DRAWING, MAKE SURE TO ADJUST FOR PROPER SCALING

9.2 MODEL 737-200

9.2.1 Scaled Drawings – 1 IN. = 32 FT: Model 737-200

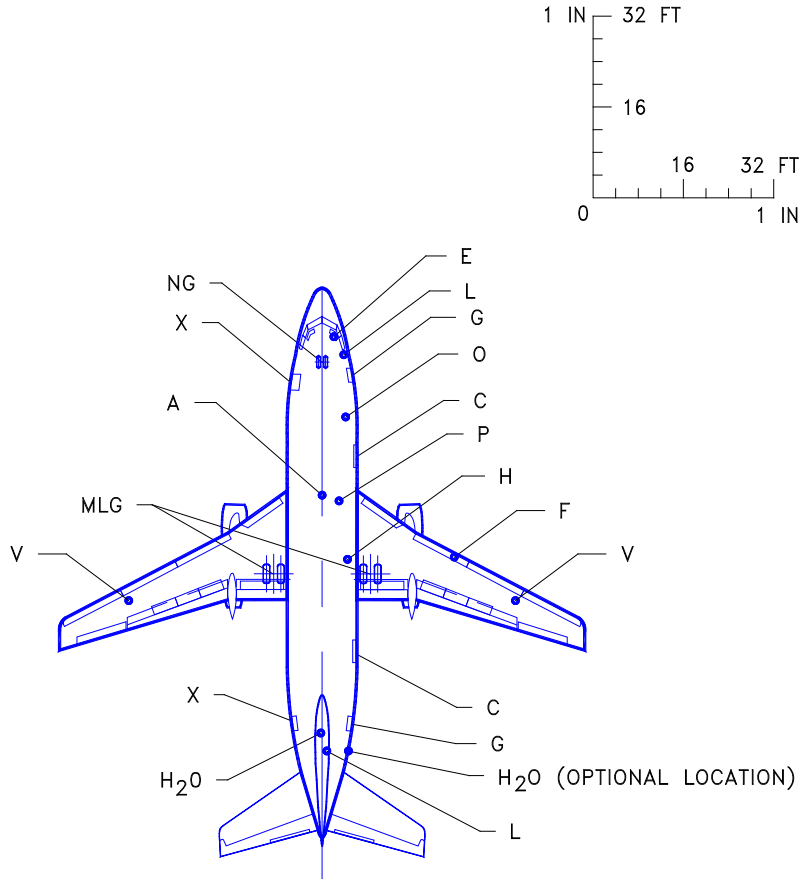

LEGEND

A	AIR CONDITIONING
C	CARGO DOOR
E	ELECTRICAL
F	FUEL
G	SERVICE DOOR
H ₂ O	POTABLE WATER
L	LAVATORY SERVICE
MLG	MAIN LANDING GEAR
NG	NOSE LANDING GEAR
O	OXYGEN
P	PNEUMATIC (AIR START)
V	FUEL VENT
X	PASSENGER DOOR

NOTE: FOR TURNING RADIUS DATA
SEE SECTIONS 4.2 AND 4.3

NOTE: WHEN PRINTING THIS DRAWING, MAKE SURE TO ADJUST FOR PROPER SCALING

D6-58325-6

REV D

March 2023

9-12

9.2.2 Scaled Drawings – 1 IN. = 32 FT: Model 737-200

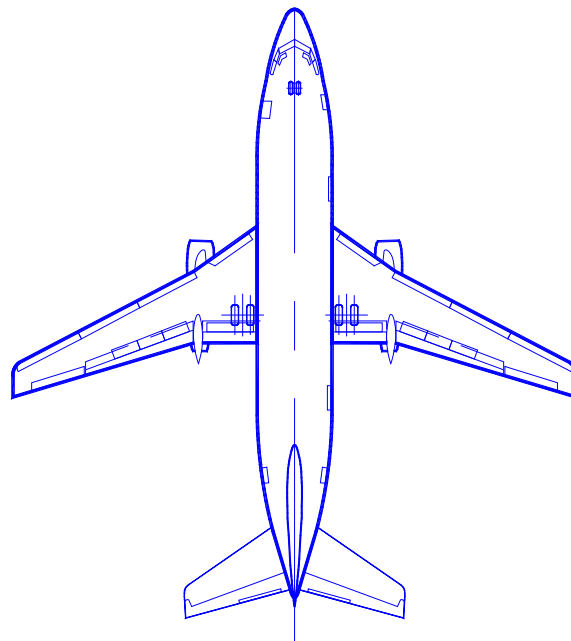
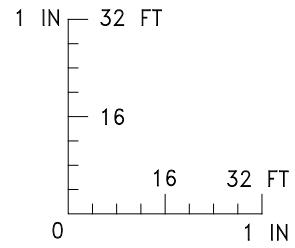

NOTE: WHEN PRINTING THIS DRAWING, MAKE SURE TO ADJUST FOR PROPER SCALING

9.2.3 Scaled Drawings – 1 IN. = 50 FT: Model 737-200

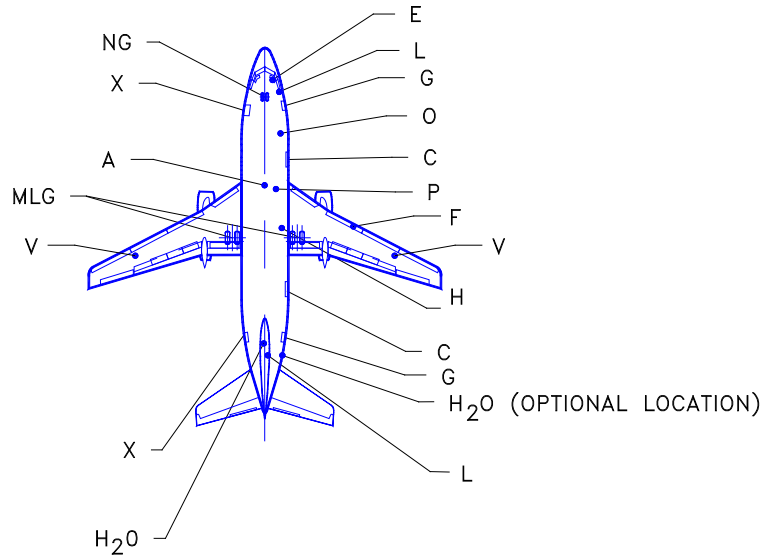
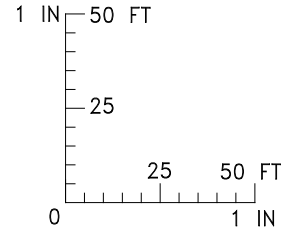

LEGEND

- A AIR CONDITIONING
- C CARGO DOOR
- E ELECTRICAL
- F FUEL
- G SERVICE DOOR
- H₂O POTABLE WATER
- L LAVATORY SERVICE
- MLG MAIN LANDING GEAR
- NG NOSE LANDING GEAR
- O OXYGEN
- P PNEUMATIC (AIR START)
- V FUEL VENT
- X PASSENGER DOOR

NOTE: FOR TURNING RADIUS DATA
SEE SECTIONS 4.2 AND 4.3

NOTE: WHEN PRINTING THIS DRAWING, MAKE SURE TO ADJUST FOR PROPER SCALING

9.2.4 Scaled Drawings – 1 IN. = 50 FT: Model 737-200

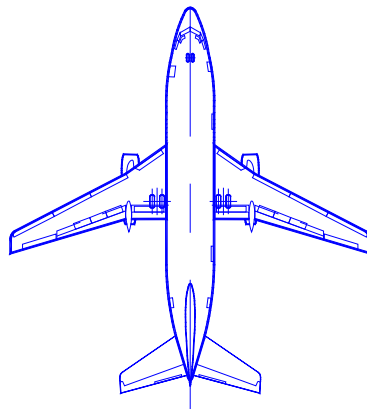
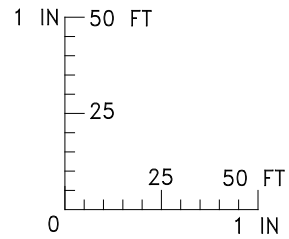

NOTE: WHEN PRINTING THIS DRAWING, MAKE SURE TO ADJUST FOR PROPER SCALING

9.2.5 Scaled Drawings – 1 IN. = 100 FT: Model 737-200

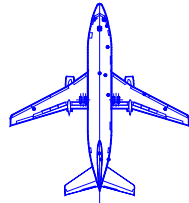
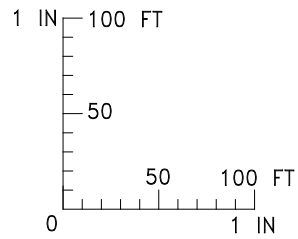

NOTE:

SEE CORRESPONDING PAGE FOR 1 IN = 32 FT
FOR IDENTIFICATIONS OF SERVICE POINTS

LEGEND

A	AIR CONDITIONING
C	CARGO DOOR
E	ELECTRICAL
F	FUEL
G	SERVICE DOOR
H O	POTABLE WATER
L	LAVATORY SERVICE
MLG	MAIN LANDING GEAR
NG	NOSE LANDING GEAR
O	OXYGEN
P	PNEUMATIC (AIR START)
V	FUEL VENT
X	PASSENGER DOOR

NOTE: FOR TURNING RADIUS DATA
SEE SECTIONS 4.2 AND 4.3

NOTE: WHEN PRINTING THIS DRAWING, MAKE SURE TO ADJUST FOR PROPER SCALING

D6-58325-6

REV D

March 2023

9-16

9.2.6 Scaled Drawings – 1 IN. = 100 FT: Model 737-200

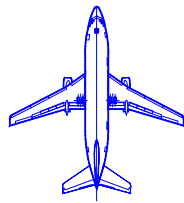
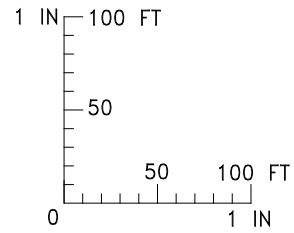

NOTE: WHEN PRINTING THIS DRAWING, MAKE SURE TO ADJUST FOR PROPER SCALING

9.2.7 Scaled Drawings – 1:500: Model 737-200

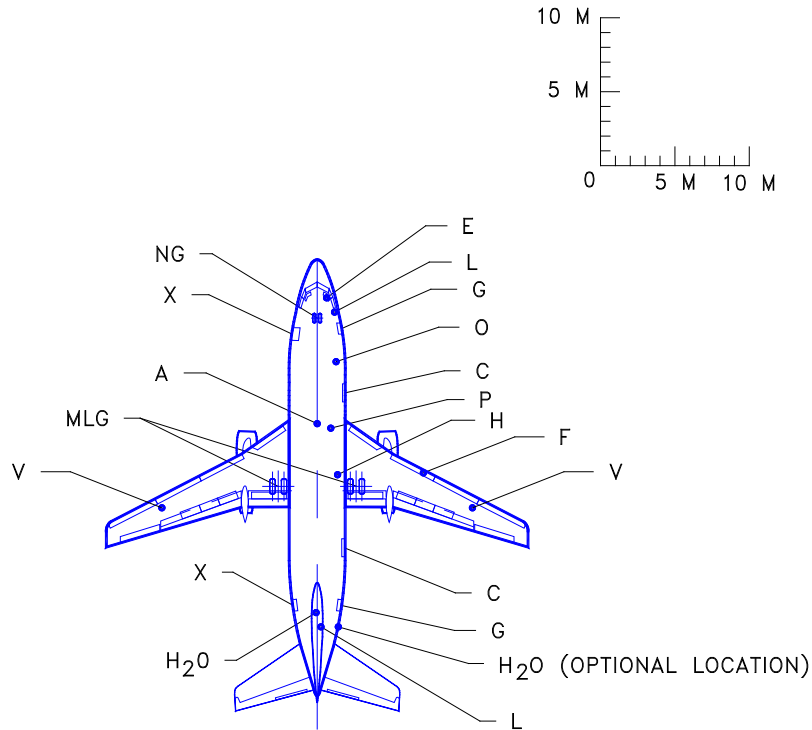

LEGEND

A	AIR CONDITIONING
C	CARGO DOOR
E	ELECTRICAL
F	FUEL
G	SERVICE DOOR
H ₂ O	POTABLE WATER
L	LAVATORY SERVICE
MLG	MAIN LANDING GEAR
NG	NOSE LANDING GEAR
O	OXYGEN
P	PNEUMATIC (AIR START)
V	FUEL VENT
X	PASSENGER DOOR

NOTE: FOR TURNING RADIUS DATA
SEE SECTIONS 4.2 AND 4.3

NOTE: WHEN PRINTING THIS DRAWING, MAKE SURE TO ADJUST FOR PROPER SCALING

D6-58325-6

REV D

March 2023

9-18

9.2.8 Scaled Drawings – 1:500: Model 737-200

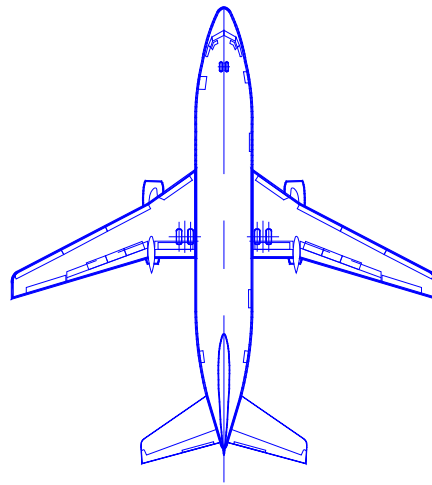
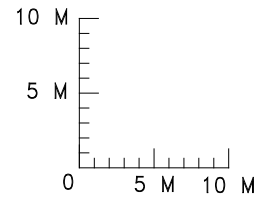

NOTE: WHEN PRINTING THIS DRAWING, MAKE SURE TO ADJUST FOR PROPER SCALING

9.2.9 Scaled Drawings – 1:1000: Model 737-200

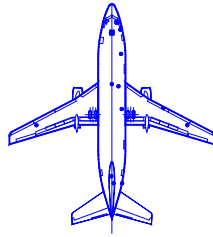
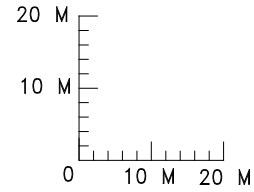

NOTE:

SEE CORRESPONDING PAGE FOR 1 IN = 32 FT
FOR IDENTIFICATIONS OF SERVICE POINTS

LEGEND

A	AIR CONDITIONING
C	CARGO DOOR
E	ELECTRICAL
F	FUEL
G	SERVICE DOOR
H O	POTABLE WATER
L	LAVATORY SERVICE
MLG	MAIN LANDING GEAR
NG	NOSE LANDING GEAR
O	OXYGEN
P	PNEUMATIC (AIR START)
V	FUEL VENT
X	PASSENGER DOOR

NOTE: FOR TURNING RADIUS DATA
SEE SECTIONS 4.2 AND 4.3

NOTE: WHEN PRINTING THIS DRAWING, MAKE SURE TO ADJUST FOR PROPER SCALING

D6-58325-6

REV D

March 2023

9-20

9.2.10 Scaled Drawings – 1:1000: Model 737-200

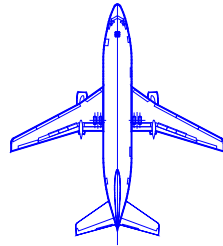
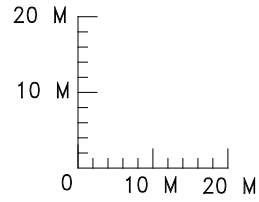

NOTE: WHEN PRINTING THIS DRAWING, MAKE SURE TO ADJUST FOR PROPER SCALING

9.3 MODEL 737-300

9.3.1 Scaled Drawings – 1 IN. = 32 FT: Model 737-300

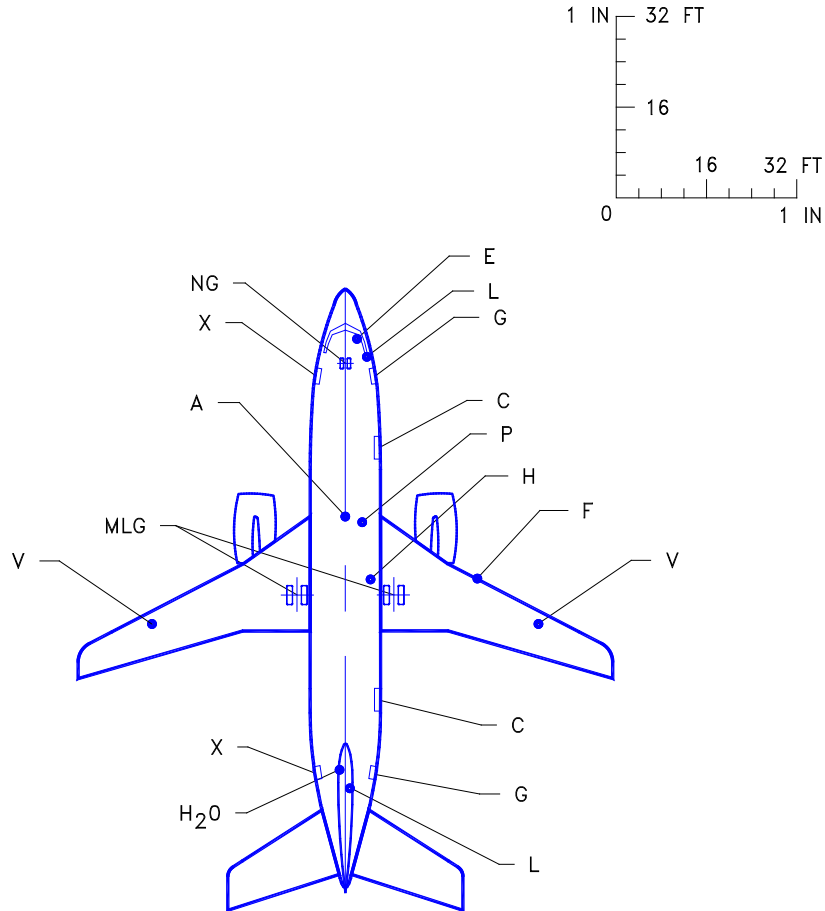

LEGEND

A	AIR CONDITIONING
C	CARGO DOOR
E	ELECTRICAL
F	FUEL
G	SERVICE DOOR
H	HYDRAULIC
H ₂ O	POTABLE WATER
L	LAVATORY SERVICE
MLG	MAIN LANDING GEAR
NG	NOSE LANDING GEAR
P	PNEUMATIC (AIR START)
V	FUEL VENT
X	PASSENGER DOOR

NOTE: FOR TURNING RADIUS DATA
SEE SECTIONS 4.2 AND 4.3

NOTE: WHEN PRINTING THIS DRAWING, MAKE SURE TO ADJUST FOR PROPER SCALING

9.3.2 Scaled Drawings – 1 IN. = 32 FT: Model 737-300

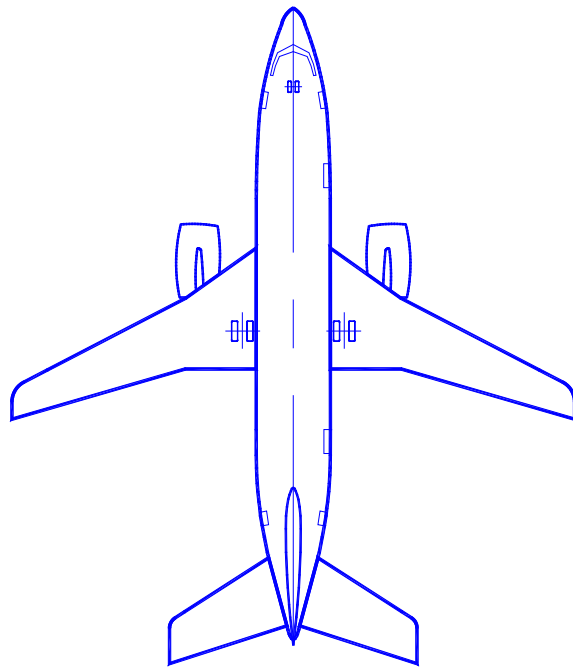
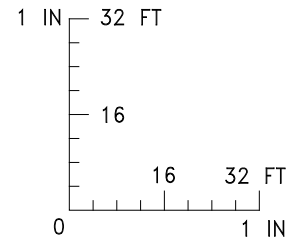

NOTE: WHEN PRINTING THIS DRAWING, MAKE SURE TO ADJUST FOR PROPER SCALING

9.3.3 Scaled Drawings – 1 IN. = 50 FT: Model 737-300

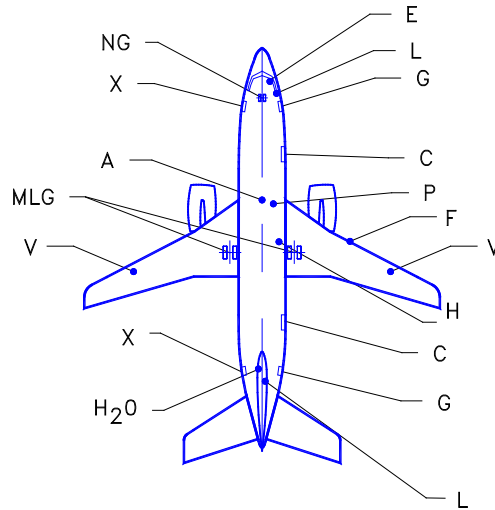
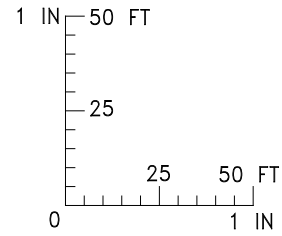

LEGEND

A	AIR CONDITIONING
C	CARGO DOOR
E	ELECTRICAL
F	FUEL
G	SERVICE DOOR
H	HYDRAULIC
H ₂ O	POTABLE WATER
L	LAVATORY SERVICE
MLG	MAIN LANDING GEAR
NG	NOSE LANDING GEAR
P	PNEUMATIC (AIR START)
V	FUEL VENT
X	PASSENGER DOOR

NOTE: FOR TURNING RADIUS DATA
SEE SECTIONS 4.2 AND 4.3

NOTE: WHEN PRINTING THIS DRAWING, MAKE SURE TO ADJUST FOR PROPER SCALING

D6-58325-6

REV D

March 2023

9-24

9.3.4 Scaled Drawings – 1 IN. = 50 FT: Model 737-300

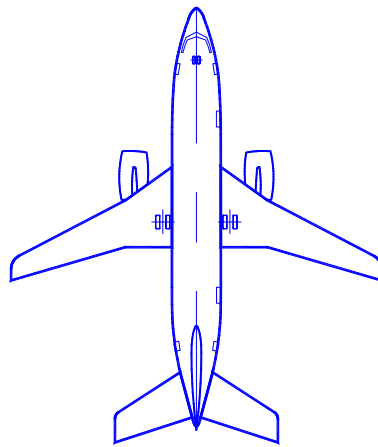
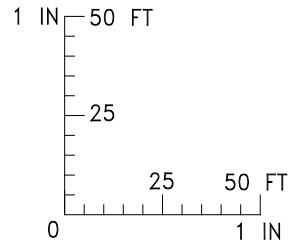

NOTE: WHEN PRINTING THIS DRAWING, MAKE SURE TO ADJUST FOR PROPER SCALING

9.3.5 Scaled Drawings – 1 IN. = 100 FT: Model 737-300

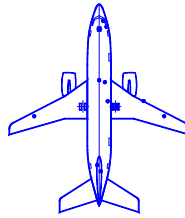
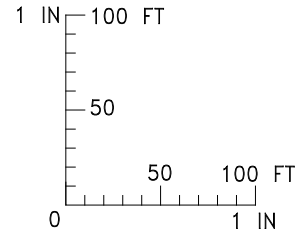

NOTE:

SEE CORRESPONDING PAGE FOR 1 IN = 32 FT
FOR IDENTIFICATIONS OF SERVICE POINTS

LEGEND

A	AIR CONDITIONING
C	CARGO DOOR
E	ELECTRICAL
F	FUEL
G	SERVICE DOOR
H	HYDRAULIC
H ₂ O	POTABLE WATER
L	LAVATORY SERVICE
MLG	MAIN LANDING GEAR
NG	NOSE LANDING GEAR
P	PNEUMATIC (AIR START)
V	FUEL VENT
X	PASSENGER DOOR

NOTE: FOR TURNING RADIUS DATA
SEE SECTIONS 4.2 AND 4.3

NOTE: WHEN PRINTING THIS DRAWING, MAKE SURE TO ADJUST FOR PROPER SCALING

D6-58325-6

REV D

March 2023

9-26

9.3.6 Scaled Drawings – 1 IN. = 100 FT: Model 737-300

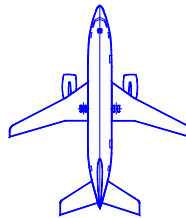
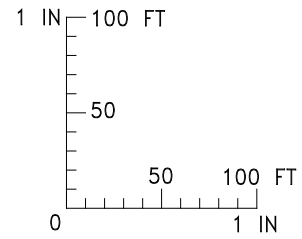

NOTE: WHEN PRINTING THIS DRAWING, MAKE SURE TO ADJUST FOR PROPER SCALING

9.3.7 Scaled Drawings – 1:500: Model 737-300

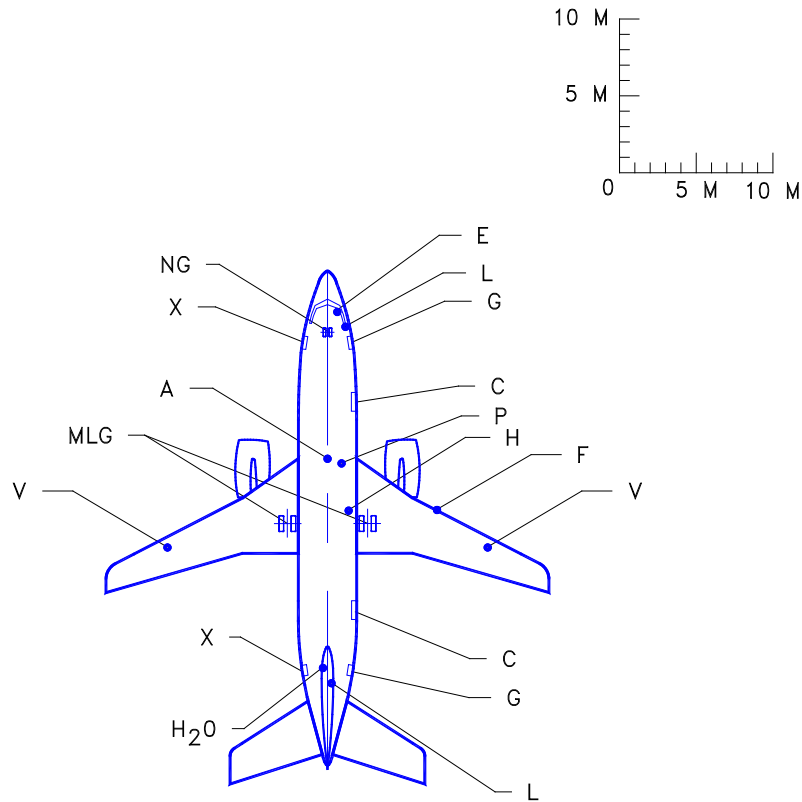

LEGEND

- A AIR CONDITIONING
- C CARGO DOOR
- E ELECTRICAL
- F FUEL
- G SERVICE DOOR
- H HYDRAULIC
- H₂O POTABLE WATER
- L LAVATORY SERVICE
- MLG MAIN LANDING GEAR
- NG NOSE LANDING GEAR
- P PNEUMATIC (AIR START)
- V FUEL VENT
- X PASSENGER DOOR

NOTE: FOR TURNING RADIUS DATA
SEE SECTIONS 4.2 AND 4.3

NOTE: WHEN PRINTING THIS DRAWING, MAKE SURE TO ADJUST FOR PROPER SCALING

D6-58325-6

REV D

March 2023

9-28

9.3.8 Scaled Drawings – 1:500: Model 737-300

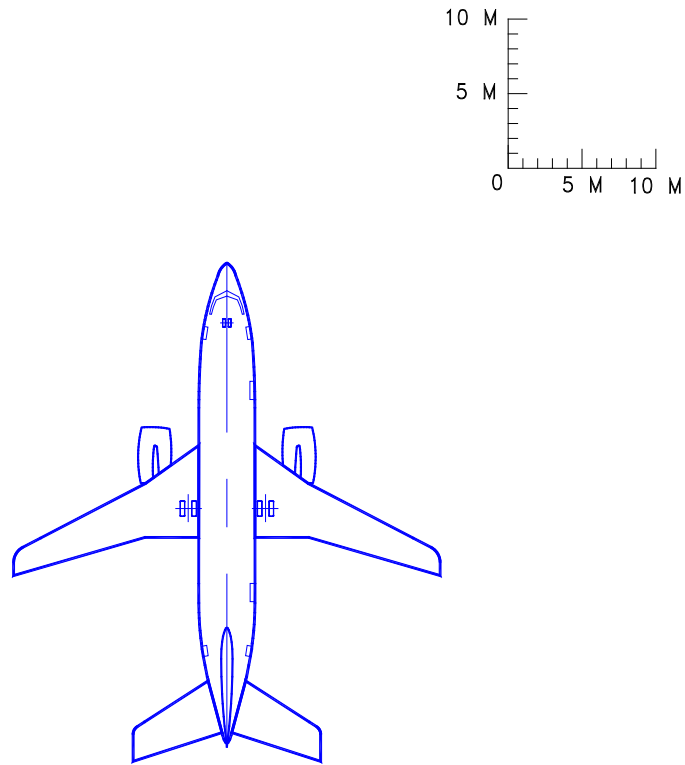

NOTE: WHEN PRINTING THIS DRAWING, MAKE SURE TO ADJUST FOR PROPER SCALING

9.3.9 Scaled Drawings – 1:1000: Model 737-300

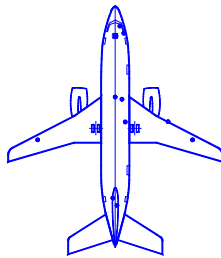
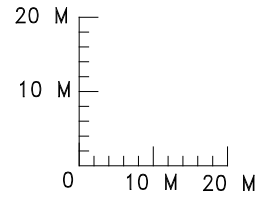

NOTE:

SEE CORRESPONDING PAGE FOR 1 IN = 32 FT
FOR IDENTIFICATIONS OF SERVICE POINTS

LEGEND

A	AIR CONDITIONING
C	CARGO DOOR
E	ELECTRICAL
F	FUEL
G	SERVICE DOOR
H ₂ O	POTABLE WATER
L	LAVATORY SERVICE
MLG	MAIN LANDING GEAR
NG	NOSE LANDING GEAR
O	OXYGEN
P	PNEUMATIC (AIR START)
V	FUEL VENT
X	PASSENGER DOOR

NOTE: FOR TURNING RADIUS DATA
SEE SECTIONS 4.2 AND 4.3

NOTE: WHEN PRINTING THIS DRAWING, MAKE SURE TO ADJUST FOR PROPER SCALING

D6-58325-6

REV D

March 2023

9-30

9.3.10 Scaled Drawings – 1:1000: Model 737-300

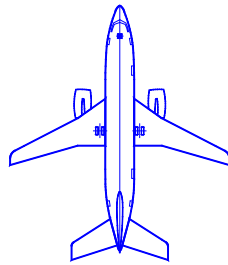
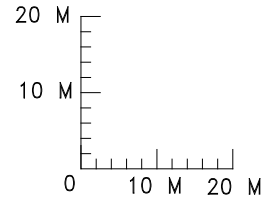

NOTE: WHEN PRINTING THIS DRAWING, MAKE SURE TO ADJUST FOR PROPER SCALING

9.4 MODEL 737-300W

9.4.1 Scaled Drawings – 1 IN. = 32 FT: Model 737-300W

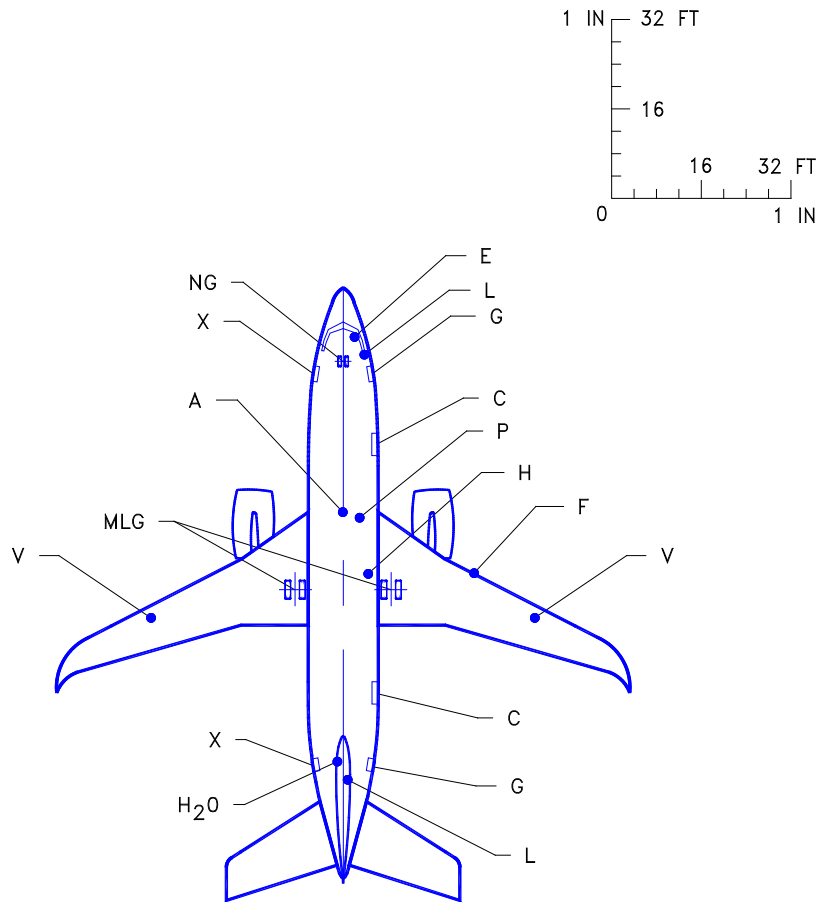

LEGEND

A	AIR CONDITIONING
C	CARGO DOOR
E	ELECTRICAL
F	FUEL
G	SERVICE DOOR
H	HYDRAULIC
H ₂ O	POTABLE WATER
L	LAVATORY SERVICE
MLG	MAIN LANDING GEAR
NG	NOSE LANDING GEAR
P	PNEUMATIC (AIR START)
V	FUEL VENT
X	PASSENGER DOOR

NOTE: FOR TURNING RADIUS DATA
SEE SECTIONS 4.2 AND 4.3

NOTE: WHEN PRINTING THIS DRAWING, MAKE SURE TO ADJUST FOR PROPER SCALING

D6-58325-6

REV D

March 2023

9-32

9.4.2 Scaled Drawings – 1 IN. = 32 FT: Model 737-300W

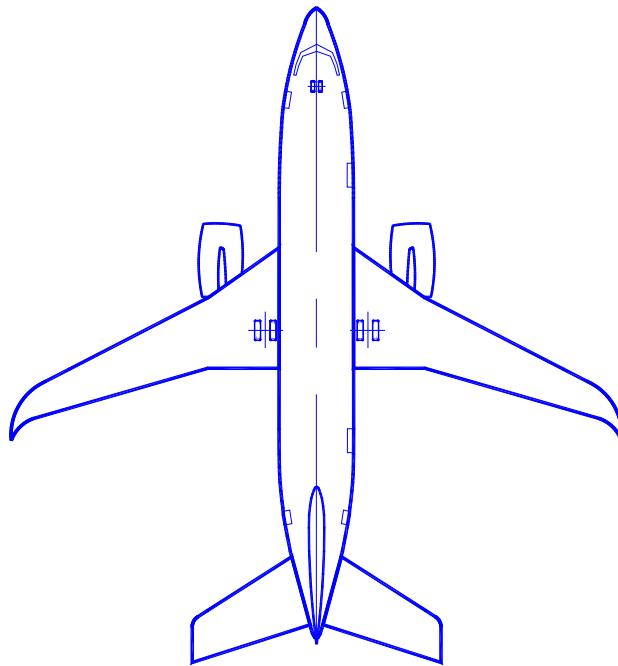
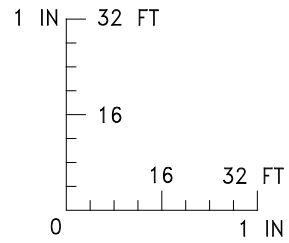

NOTE: WHEN PRINTING THIS DRAWING, MAKE SURE TO ADJUST FOR PROPER SCALING

9.4.3 Scaled Drawings – 1 IN. = 50 FT: Model 737-300W

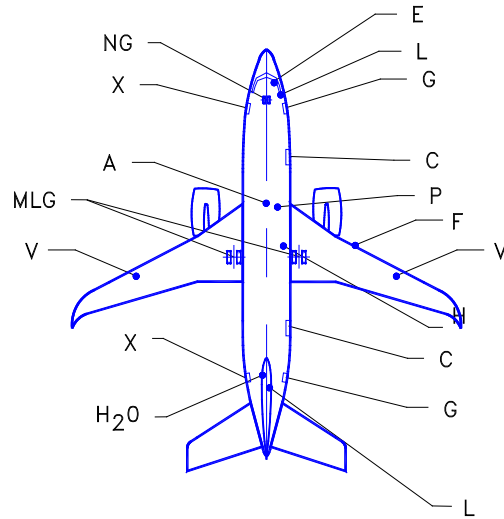
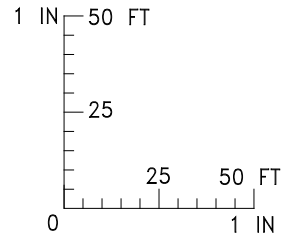

LEGEND

- A AIR CONDITIONING
- C CARGO DOOR
- E ELECTRICAL
- F FUEL
- G SERVICE DOOR
- H HYDRAULIC
- H₂O POTABLE WATER
- L LAVATORY SERVICE
- MLG MAIN LANDING GEAR
- NG NOSE LANDING GEAR
- P PNEUMATIC (AIR START)
- V FUEL VENT
- X PASSENGER DOOR

NOTE: FOR TURNING RADIUS DATA
SEE SECTIONS 4.2 AND 4.3

NOTE: WHEN PRINTING THIS DRAWING, MAKE SURE TO ADJUST FOR PROPER SCALING

9.4.4 Scaled Drawings – 1 IN. = 50 FT: Model 737-300W

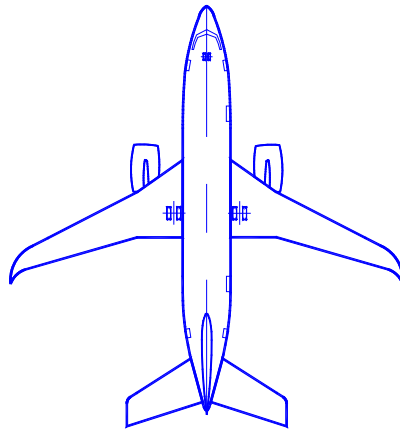
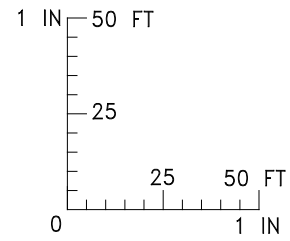

NOTE: WHEN PRINTING THIS DRAWING, MAKE SURE TO ADJUST FOR PROPER SCALING

9.4.5 Scaled Drawings – 1 IN. = 100 FT: Model 737-300W

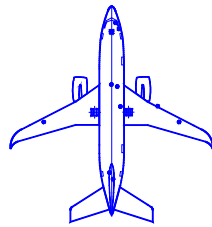
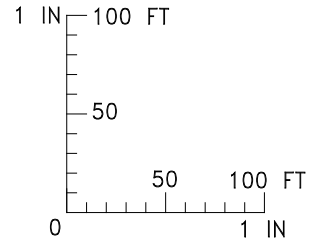

NOTE:

SEE CORRESPONDING PAGE FOR 1 IN = 32 FT
FOR IDENTIFICATIONS OF SERVICE POINTS

LEGEND

A	AIR CONDITIONING
C	CARGO DOOR
E	ELECTRICAL
F	FUEL
G	SERVICE DOOR
H	HYDRAULIC
H ₂ O	POTABLE WATER
L	LAVATORY SERVICE
MLG	MAIN LANDING GEAR
NG	NOSE LANDING GEAR
P	PNEUMATIC (AIR START)
V	FUEL VENT
X	PASSENGER DOOR

NOTE: FOR TURNING RADIUS DATA
SEE SECTIONS 4.2 AND 4.3

NOTE: WHEN PRINTING THIS DRAWING, MAKE SURE TO ADJUST FOR PROPER SCALING

D6-58325-6

REV D

March 2023

9-36

9.4.6 Scaled Drawings – 1 IN. = 100 FT: Model 737-300W

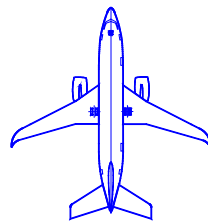
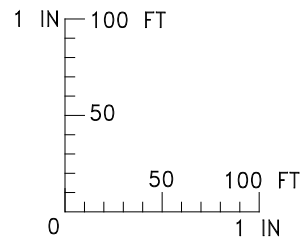

NOTE: WHEN PRINTING THIS DRAWING, MAKE SURE TO ADJUST FOR PROPER SCALING

9.4.7 Scaled Drawings – 1:500: Model 737-300W

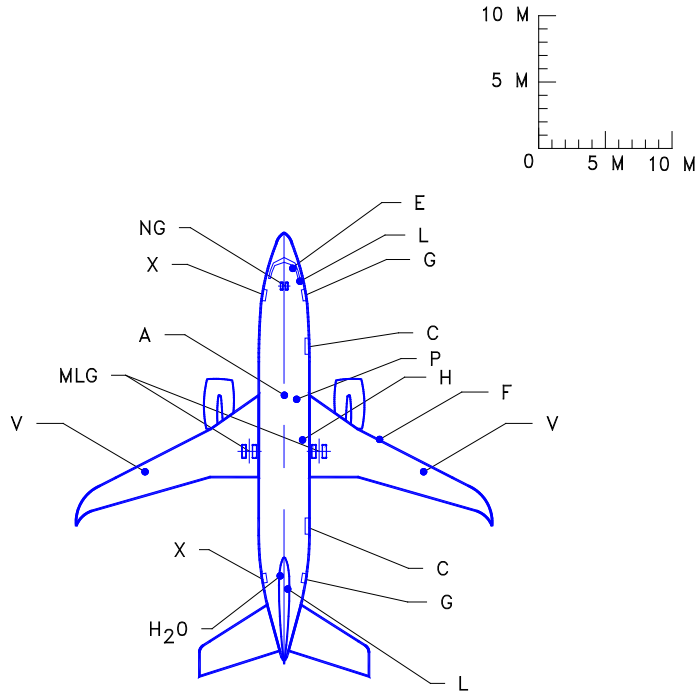

LEGEND

A	AIR CONDITIONING
C	CARGO DOOR
E	ELECTRICAL
F	FUEL
G	SERVICE DOOR
H	HYDRAULIC
H ₂ O	POTABLE WATER
L	LAVATORY SERVICE
MLG	MAIN LANDING GEAR
NG	NOSE LANDING GEAR
P	PNEUMATIC (AIR START)
V	FUEL VENT
X	PASSENGER DOOR

NOTE: FOR TURNING RADIUS DATA
SEE SECTIONS 4.2 AND 4.3

NOTE: WHEN PRINTING THIS DRAWING, MAKE SURE TO ADJUST FOR PROPER SCALING

9.4.8 Scaled Drawings – 1:500: Model 737-300W

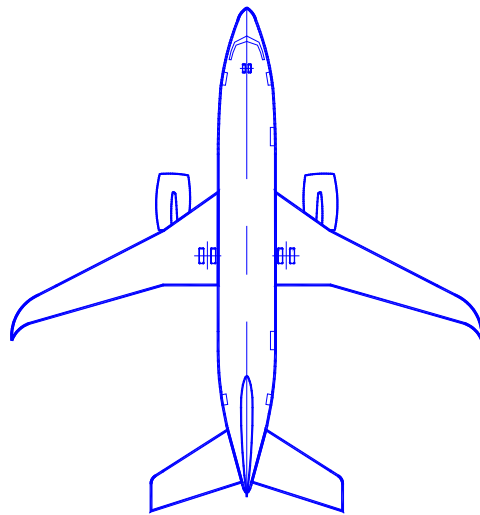
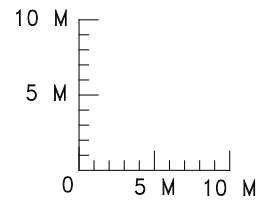

NOTE: WHEN PRINTING THIS DRAWING, MAKE SURE TO ADJUST FOR PROPER SCALING

9.4.9 Scaled Drawings – 1:1000: Model 737-300W

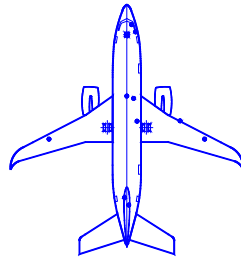
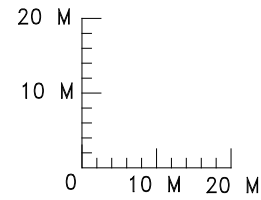

NOTE:

SEE CORRESPONDING PAGE FOR 1 IN = 32 FT
FOR IDENTIFICATIONS OF SERVICE POINTS

LEGEND

A	AIR CONDITIONING
C	CARGO DOOR
E	ELECTRICAL
F	FUEL
G	SERVICE DOOR
H ₂ O	POTABLE WATER
L	LAVATORY SERVICE
MLG	MAIN LANDING GEAR
NG	NOSE LANDING GEAR
O	OXYGEN
P	PNEUMATIC (AIR START)
V	FUEL VENT
X	PASSENGER DOOR

NOTE: FOR TURNING RADIUS DATA
SEE SECTIONS 4.2 AND 4.3

NOTE: WHEN PRINTING THIS DRAWING, MAKE SURE TO ADJUST FOR PROPER SCALING

D6-58325-6

REV D

March 2023

9-40

9.4.10 Scaled Drawings – 1:1000: Model 737-300W

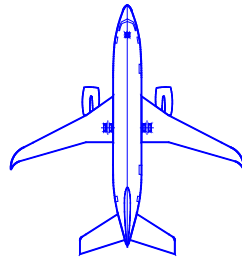
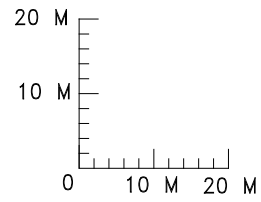

NOTE: WHEN PRINTING THIS DRAWING, MAKE SURE TO ADJUST FOR PROPER SCALING

9.5 MODEL 737-400

9.5.1 Scaled Drawings – 1 IN. = 32 FT: Model 737-400

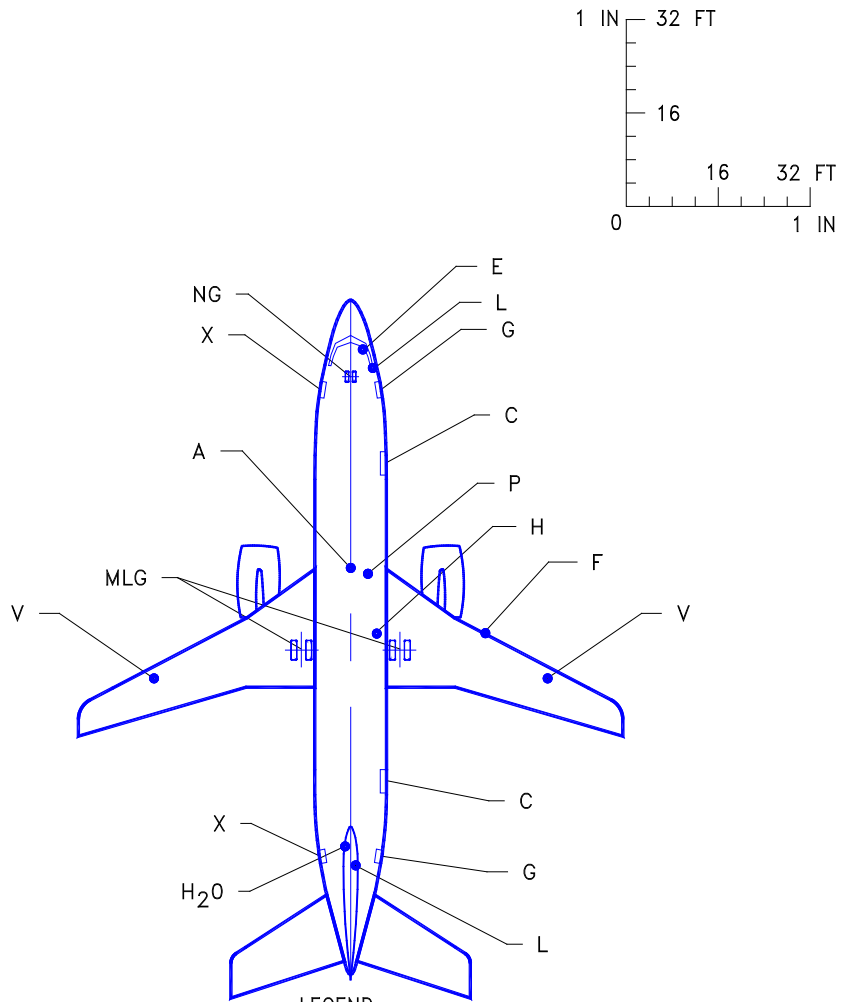

LEGEND

- A AIR CONDITIONING
- C CARGO DOOR
- E ELECTRICAL
- F FUEL
- G SERVICE DOOR
- H HYDRAULIC
- H₂O POTABLE WATER
- L LAVATORY SERVICE
- MLG MAIN LANDING GEAR
- NG NOSE LANDING GEAR
- P PNEUMATIC (AIR START)
- V FUEL VENT
- X PASSENGER DOOR

NOTE: FOR TURNING RADIUS DATA
SEE SECTIONS 4.2 AND 4.3

NOTE: WHEN PRINTING THIS DRAWING, MAKE SURE TO ADJUST FOR PROPER SCALING

D6-58325-6

REV D

March 2023

9-42

9.5.2 Scaled Drawings – 1 IN. = 32 FT: Model 737-400

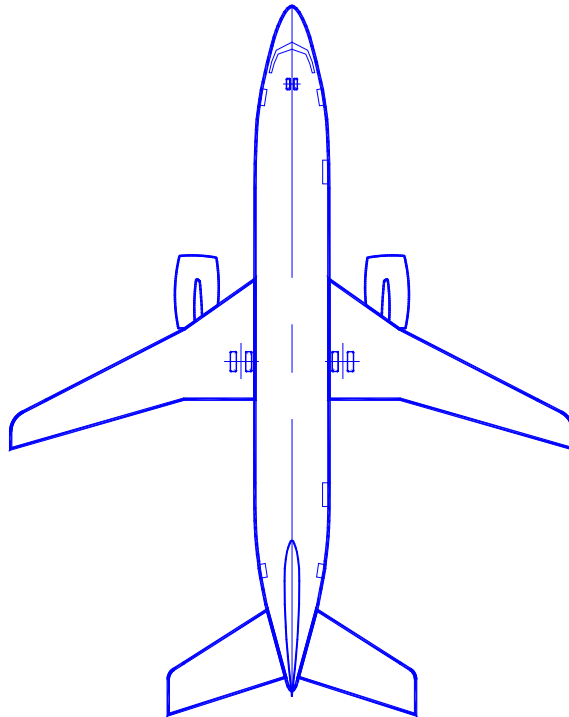
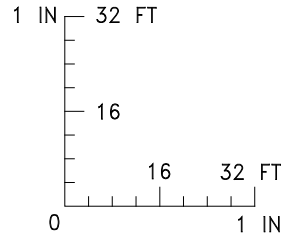

NOTE: WHEN PRINTING THIS DRAWING, MAKE SURE TO ADJUST FOR PROPER SCALING

9.5.3 Scaled Drawings – 1 IN. = 50 FT: Model 737-400

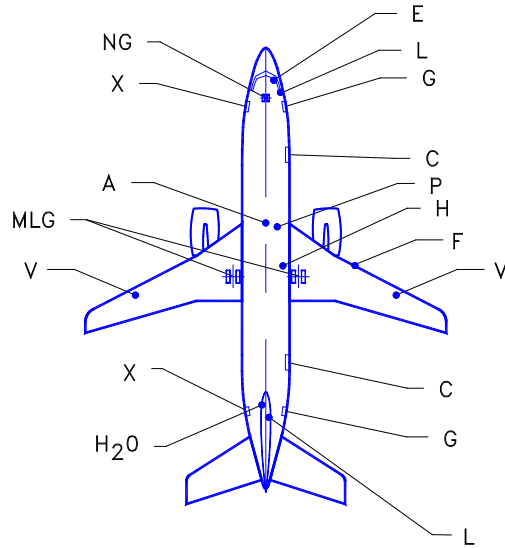
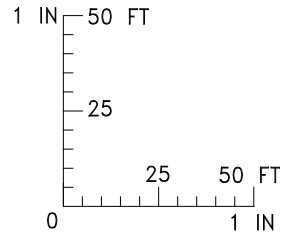

LEGEND

- A AIR CONDITIONING
- C CARGO DOOR
- E ELECTRICAL
- F FUEL
- G SERVICE DOOR
- H HYDRAULIC
- H₂O POTABLE WATER
- L LAVATORY SERVICE
- MLG MAIN LANDING GEAR
- NG NOSE LANDING GEAR
- P PNEUMATIC (AIR START)
- V FUEL VENT
- X PASSENGER DOOR

NOTE: FOR TURNING RADIUS DATA
SEE SECTIONS 4.2 AND 4.3

NOTE: WHEN PRINTING THIS DRAWING, MAKE SURE TO ADJUST FOR PROPER SCALING

D6-58325-6

REV D

March 2023

9-44

9.5.4 Scaled Drawings – 1 IN. = 50 FT: Model 737-400

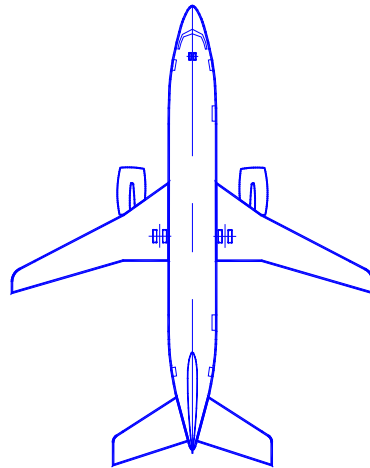
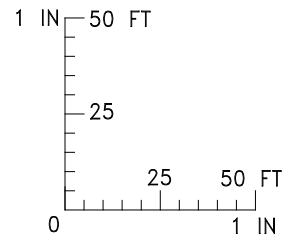

NOTE: WHEN PRINTING THIS DRAWING, MAKE SURE TO ADJUST FOR PROPER SCALING

9.5.5 Scaled Drawings – 1 IN. = 100 FT: Model 737-400

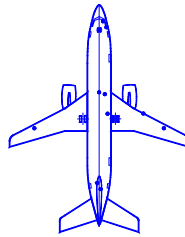
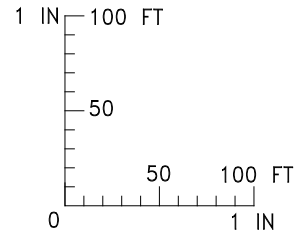

NOTE:

SEE CORRESPONDING PAGE FOR 1 IN = 32 FT
FOR IDENTIFICATIONS OF SERVICE POINTS

LEGEND

A	AIR CONDITIONING
C	CARGO DOOR
E	ELECTRICAL
F	FUEL
G	SERVICE DOOR
H	HYDRAULIC
H ₂ O	POTABLE WATER
L	LAVATORY SERVICE
MLG	MAIN LANDING GEAR
NG	NOSE LANDING GEAR
P	PNEUMATIC (AIR START)
V	FUEL VENT
X	PASSENGER DOOR

NOTE: FOR TURNING RADIUS DATA
SEE SECTIONS 4.2 AND 4.3

NOTE: WHEN PRINTING THIS DRAWING, MAKE SURE TO ADJUST FOR PROPER SCALING

D6-58325-6

REV D

March 2023

9-46

9.5.6 Scaled Drawings – 1 IN. = 100 FT: Model 737-400

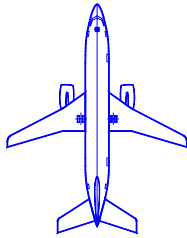
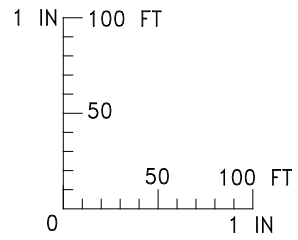

NOTE: WHEN PRINTING THIS DRAWING, MAKE SURE TO ADJUST FOR PROPER SCALING

9.5.7 Scaled Drawings – 1:500: Model 737-400

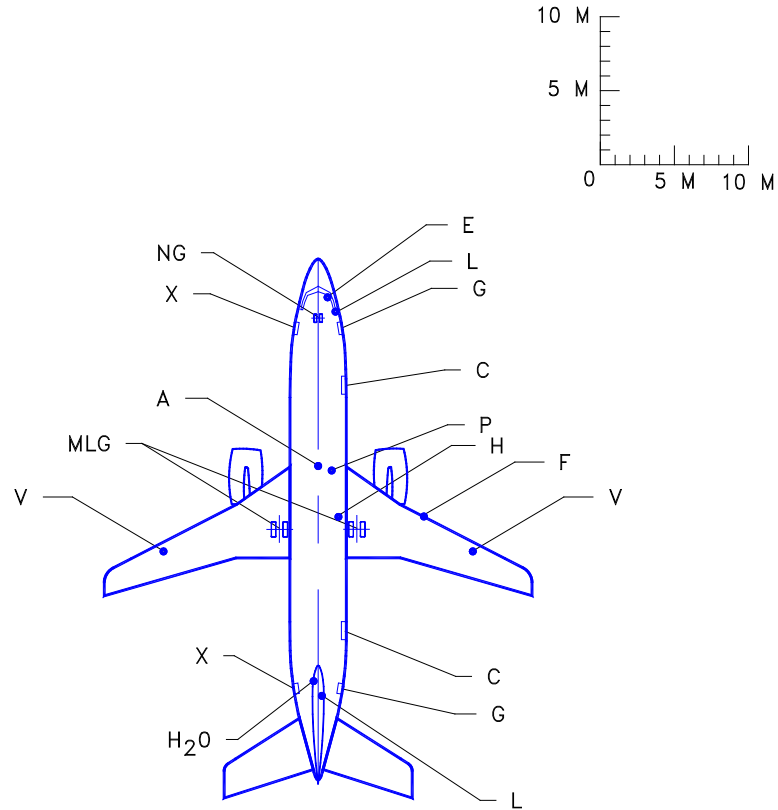

LEGEND

A	AIR CONDITIONING
C	CARGO DOOR
E	ELECTRICAL
F	FUEL
G	SERVICE DOOR
H	HYDRAULIC
H ₂ O	POTABLE WATER
L	LAVATORY SERVICE
MLG	MAIN LANDING GEAR
NG	NOSE LANDING GEAR
P	PNEUMATIC (AIR START)
V	FUEL VENT
X	PASSENGER DOOR

NOTE: FOR TURNING RADIUS DATA
SEE SECTIONS 4.2 AND 4.3

NOTE: WHEN PRINTING THIS DRAWING, MAKE SURE TO ADJUST FOR PROPER SCALING

D6-58325-6

REV D

March 2023

9-48

9.5.8 Scaled Drawings – 1:500: Model 737-400

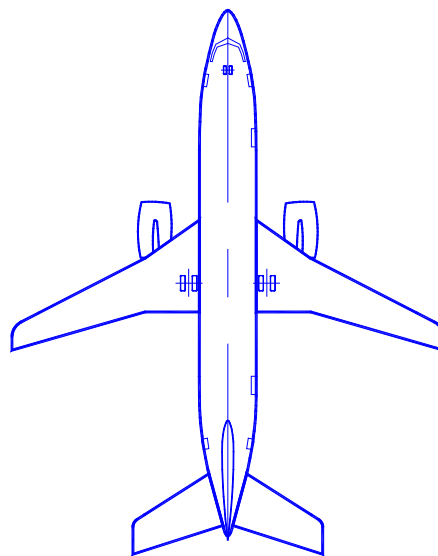
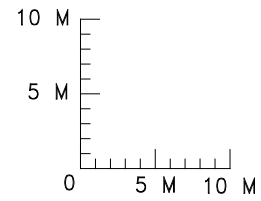

NOTE: WHEN PRINTING THIS DRAWING, MAKE SURE TO ADJUST FOR PROPER SCALING

9.5.9 Scaled Drawings – 1:1000: Model 737-400

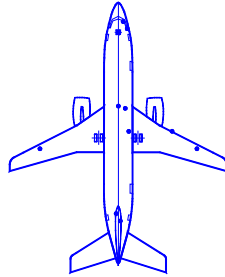
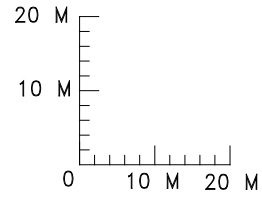

NOTE:

SEE CORRESPONDING PAGE FOR 1 IN = 32 FT
FOR IDENTIFICATIONS OF SERVICE POINTS

LEGEND

A	AIR CONDITIONING
C	CARGO DOOR
E	ELECTRICAL
F	FUEL
G	SERVICE DOOR
H ₂ O	POTABLE WATER
L	LAVATORY SERVICE
MLG	MAIN LANDING GEAR
NG	NOSE LANDING GEAR
O	OXYGEN
P	PNEUMATIC (AIR START)
V	FUEL VENT
X	PASSENGER DOOR

NOTE: FOR TURNING RADIUS DATA
SEE SECTIONS 4.2 AND 4.3

NOTE: WHEN PRINTING THIS DRAWING, MAKE SURE TO ADJUST FOR PROPER SCALING

D6-58325-6

REV D

March 2023

9-50

9.5.10 Scaled Drawings – 1:1000: Model 737-400

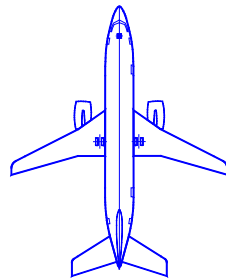
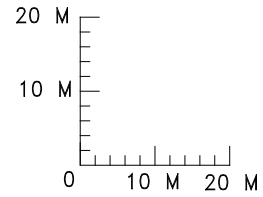

NOTE: WHEN PRINTING THIS DRAWING, MAKE SURE TO ADJUST FOR PROPER SCALING

9.6 MODEL 737-500

9.6.1 Scaled Drawings – 1 IN. = 32 FT: Model 737-500

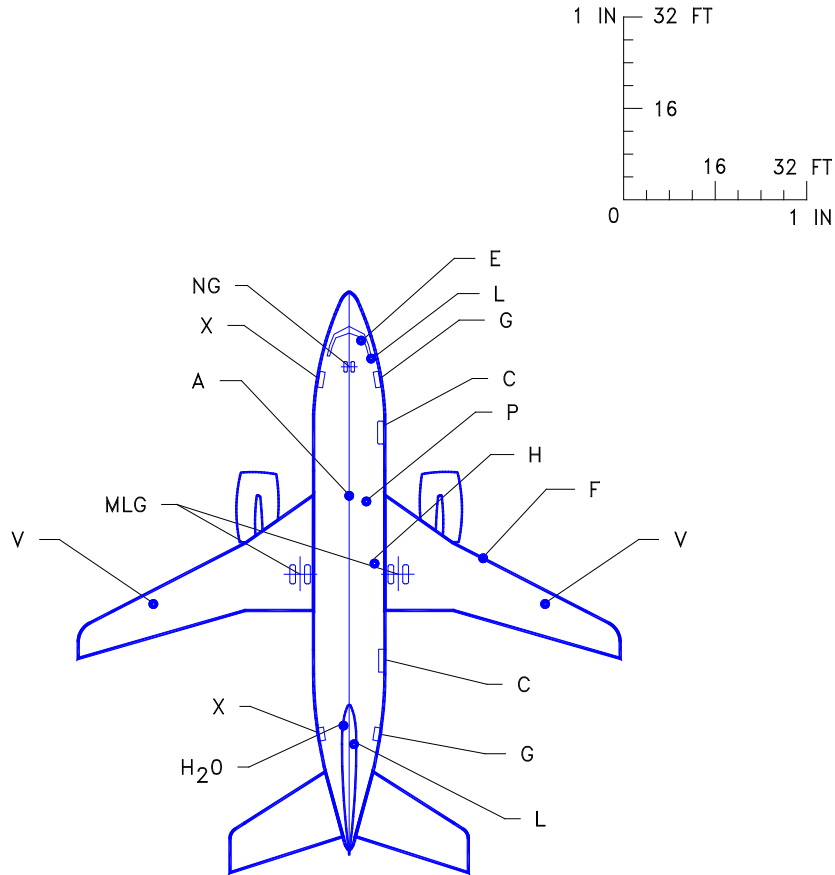

LEGEND

A	AIR CONDITIONING
C	CARGO DOOR
E	ELECTRICAL
F	FUEL
G	SERVICE DOOR
H	HYDRAULIC
H ₂ O	POTABLE WATER
L	LAVATORY SERVICE
MLG	MAIN LANDING GEAR
NG	NOSE LANDING GEAR
P	PNEUMATIC (AIR START)
V	FUEL VENT
X	PASSENGER DOOR

NOTE: FOR TURNING RADIUS DATA
SEE SECTIONS 4.2 AND 4.3

NOTE: WHEN PRINTING THIS DRAWING, MAKE SURE TO ADJUST FOR PROPER SCALING

D6-58325-6

REV D

March 2023

9-52

9.6.2 Scaled Drawings – 1 IN. = 32 FT: Model 737-500

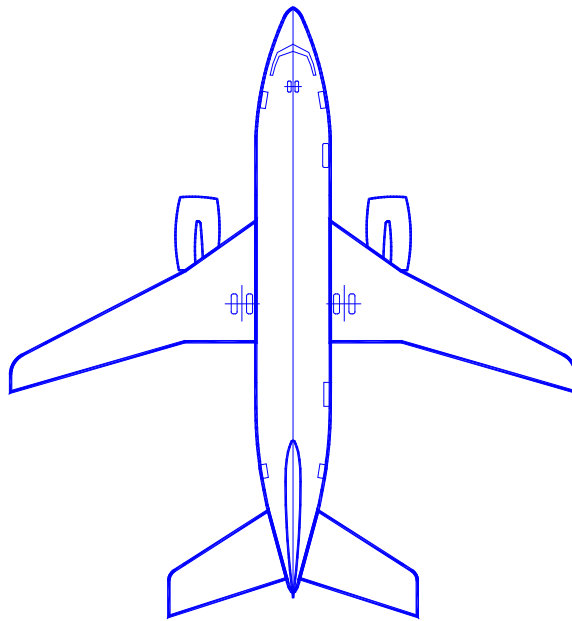
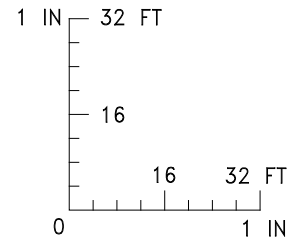

NOTE: WHEN PRINTING THIS DRAWING, MAKE SURE TO ADJUST FOR PROPER SCALING

9.6.3 Scaled Drawings – 1 IN. = 50 FT: Model 737-500

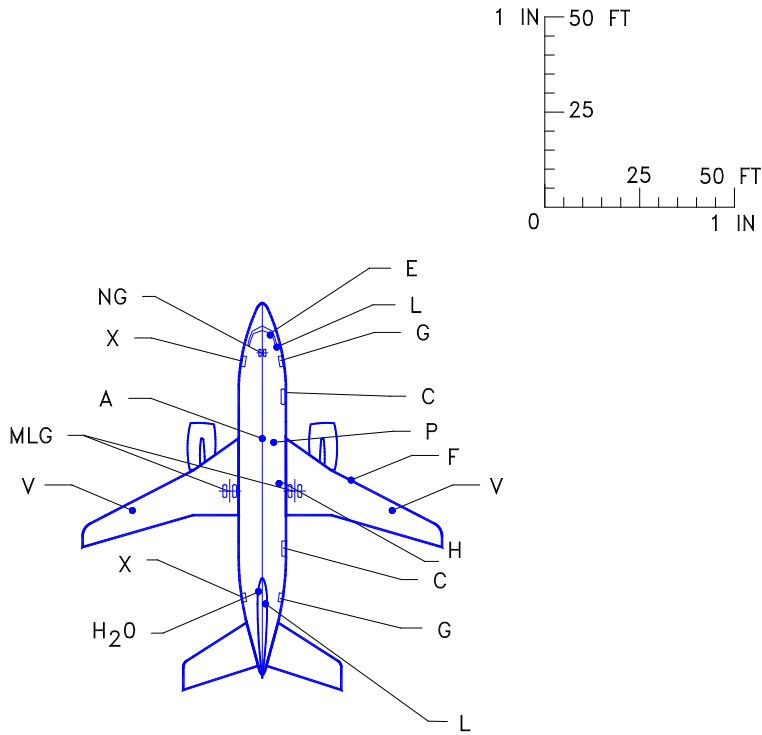

LEGEND

A	AIR CONDITIONING
C	CARGO DOOR
E	ELECTRICAL
F	FUEL
G	SERVICE DOOR
H	HYDRAULIC
H ₂ O	POTABLE WATER
L	LAVATORY SERVICE
MLG	MAIN LANDING GEAR
NG	NOSE LANDING GEAR
P	PNEUMATIC (AIR START)
V	FUEL VENT
X	PASSENGER DOOR

NOTE: FOR TURNING RADIUS DATA
SEE SECTIONS 4.2 AND 4.3

NOTE: WHEN PRINTING THIS DRAWING, MAKE SURE TO ADJUST FOR PROPER SCALING

D6-58325-6

REV D

March 2023

9-54

9.6.4 Scaled Drawings – 1 IN. = 50 FT: Model 737-500

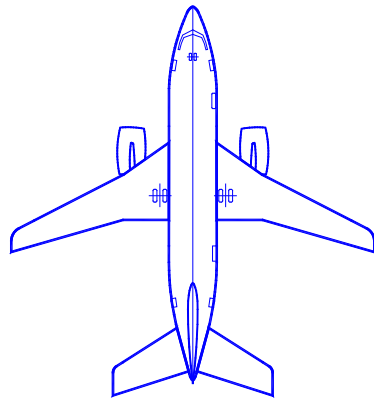
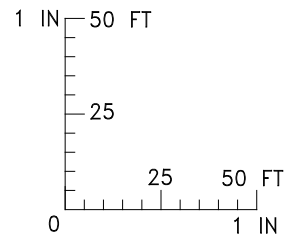

NOTE: WHEN PRINTING THIS DRAWING, MAKE SURE TO ADJUST FOR PROPER SCALING

9.6.5 Scaled Drawings – 1 IN. = 100 FT: Model 737-500

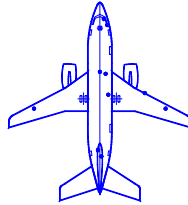
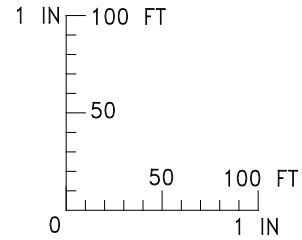

NOTE:

SEE CORRESPONDING PAGE FOR 1 IN = 32 FT
FOR IDENTIFICATIONS OF SERVICE POINTS

LEGEND

A	AIR CONDITIONING
C	CARGO DOOR
E	ELECTRICAL
F	FUEL
G	SERVICE DOOR
H	HYDRAULIC
H ₂ O	POTABLE WATER
L	LAVATORY SERVICE
MLG	MAIN LANDING GEAR
NG	NOSE LANDING GEAR
P	PNEUMATIC (AIR START)
V	FUEL VENT
X	PASSENGER DOOR

NOTE: FOR TURNING RADIUS DATA
SEE SECTIONS 4.2 AND 4.3

NOTE: WHEN PRINTING THIS DRAWING, MAKE SURE TO ADJUST FOR PROPER SCALING

D6-58325-6

REV D

March 2023

9-56

9.6.6 Scaled Drawings – 1 IN. = 100 FT: Model 737-500

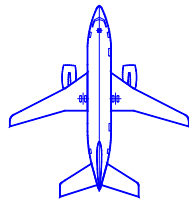
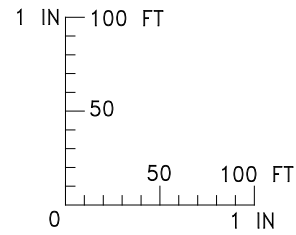

NOTE: WHEN PRINTING THIS DRAWING, MAKE SURE TO ADJUST FOR PROPER SCALING

9.6.7 Scaled Drawings – 1:500: Model 737-500

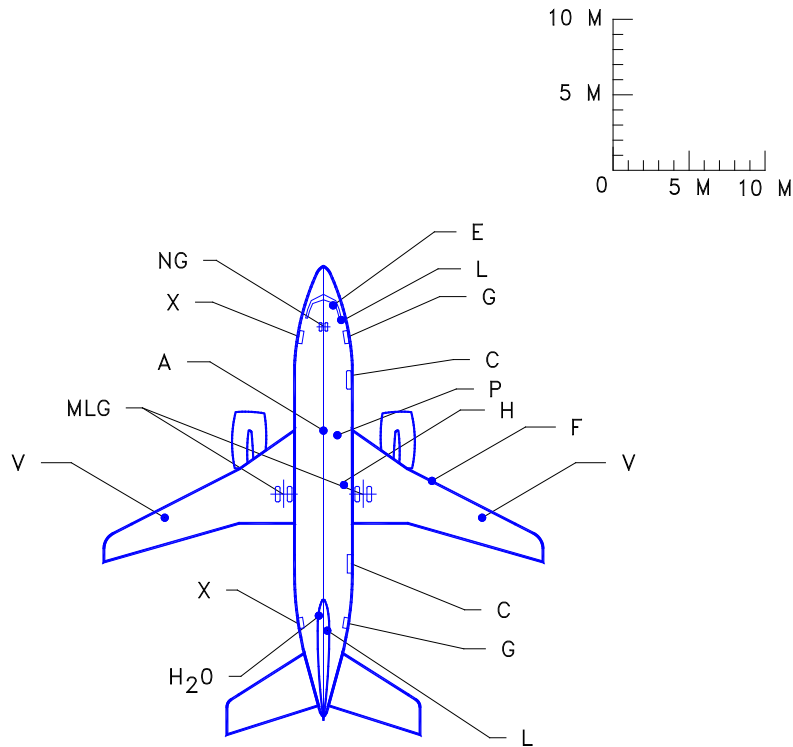

LEGEND

A	AIR CONDITIONING
C	CARGO DOOR
E	ELECTRICAL
F	FUEL
G	SERVICE DOOR
H	HYDRAULIC
H ₂ O	POTABLE WATER
L	LAVATORY SERVICE
MLG	MAIN LANDING GEAR
NG	NOSE LANDING GEAR
P	PNEUMATIC (AIR START)
V	FUEL VENT
X	PASSENGER DOOR

NOTE: FOR TURNING RADIUS DATA
SEE SECTIONS 4.2 AND 4.3

NOTE: WHEN PRINTING THIS DRAWING, MAKE SURE TO ADJUST FOR PROPER SCALING

D6-58325-6

REV D

March 2023

9-58

9.6.8 Scaled Drawings – 1:500: Model 737-500

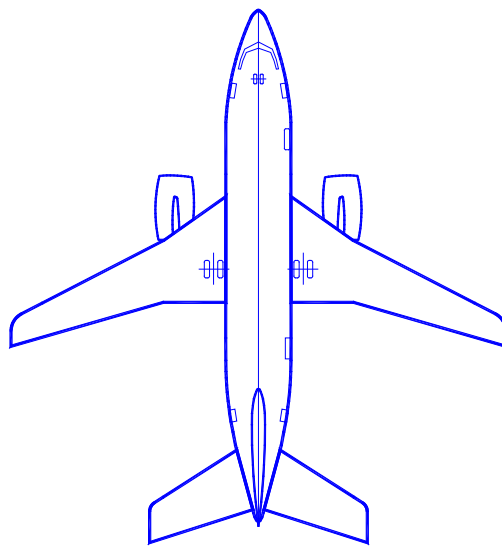
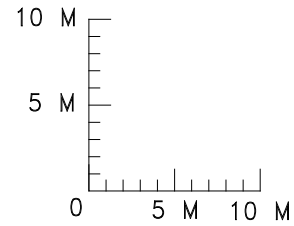

NOTE: WHEN PRINTING THIS DRAWING, MAKE SURE TO ADJUST FOR PROPER SCALING

9.6.9 Scaled Drawings – 1:1000: Model 737-500

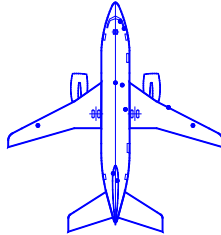
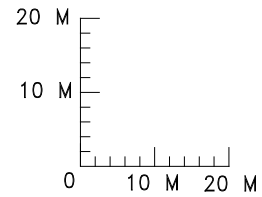

NOTE:

SEE CORRESPONDING PAGE FOR 1 IN = 32 FT
FOR IDENTIFICATIONS OF SERVICE POINTS

LEGEND

A	AIR CONDITIONING
C	CARGO DOOR
E	ELECTRICAL
F	FUEL
G	SERVICE DOOR
H ₂ O	POTABLE WATER
L	LAVATORY SERVICE
MLG	MAIN LANDING GEAR
NG	NOSE LANDING GEAR
O	OXYGEN
P	PNEUMATIC (AIR START)
V	FUEL VENT
X	PASSENGER DOOR

NOTE: FOR TURNING RADIUS DATA
SEE SECTIONS 4.2 AND 4.3

NOTE: WHEN PRINTING THIS DRAWING, MAKE SURE TO ADJUST FOR PROPER SCALING

9.6.10 Scaled Drawings – 1:1000: Model 737-500

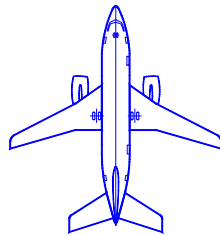
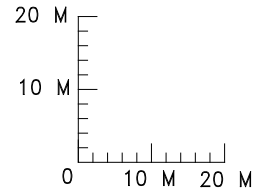

NOTE: WHEN PRINTING THIS DRAWING, MAKE SURE TO ADJUST FOR PROPER SCALING